





STIMULATE YOUR SENSES

At RZ Medizintechnik, patient health drives everything we do. Our mission is to support surgeons with innovative solutions that enable advanced, minimally invasive and tissue-preserving procedures. As a family-owned medical technology company with over 30 years of experience, we combine hands-on expertise with a strong focus on continuous innovation.

This is reflected in our portfolio: EESy instrumentation for endoscopic ear surgery, FINESS instruments designed for maximum precision in microsurgical ear procedures, and OSTRAL – our mouth gag system for transoral robotic surgery.

Each solution is developed to meet the evolving demands of modern surgery – enhancing precision, improving usability, and supporting better patient outcomes. “Progress in Surgery” is more than a guiding principle. It’s what we deliver every day – for surgeons and their patients.



DEDICATED TO QUALITY

The quality of our products is the result of careful craftsmanship and advanced manufacturing. Each instrument is produced locally by experienced surgical instrument makers, combining expertise, precision, and state-of-the-art technology.

The result is long-lasting durability, reliable performance, and cost-effective use over time — along with a high level of safety for both patients and users in daily clinical practice.

All RZ Medizintechnik products are developed and manufactured in accordance with MDR requirements and FDA standards, meeting international expectations for safety, quality, and performance.



TABLE OF CONTENTS



OTOLOGY

Page 7 - 90



RHINOLOGY

Page 91 - 180



SINUSCOPY

Page 181 - 226

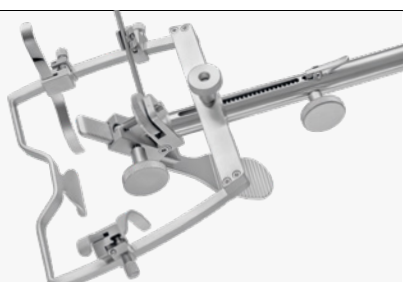

ORAL

Page 227 - 266



LARYNGOSCOPY

Page 267 - 302

INDEX

Page 302 - 322

OTOLOGY



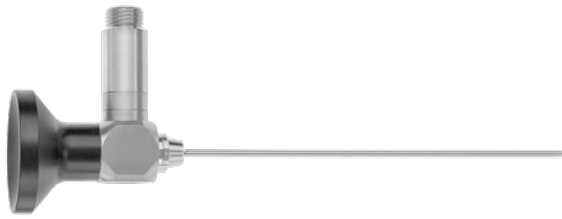
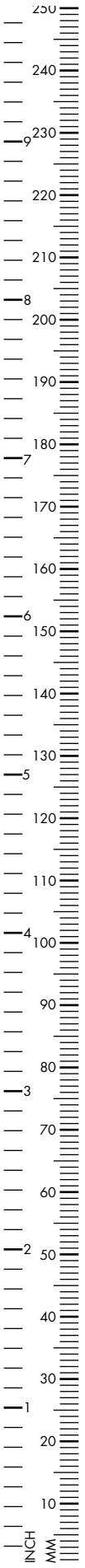

Otoscope, 100mm working length, Ø 1.9mm	
0°	410-019-100
30°	410-019-130



Otoscope, 75mm working length, Ø 2.7mm	
0°	410-027-000
30°	410-027-030
70°	410-027-070



Otoscope, 110mm working length, Ø 2.7mm	
0°	410-027-100
30°	410-027-130



Otoscope, 50mm working length, Ø 4.0mm	
0°	410-004-000
30°	410-004-030

LED PORTABLE LIGHT SOURCE

- Intensive Lighting (max. 1000 lumen)
- 4 adjustable brightness levels
- Water resistant (IPX8)
- Magnetic USB charger included
- Long lifetime battery

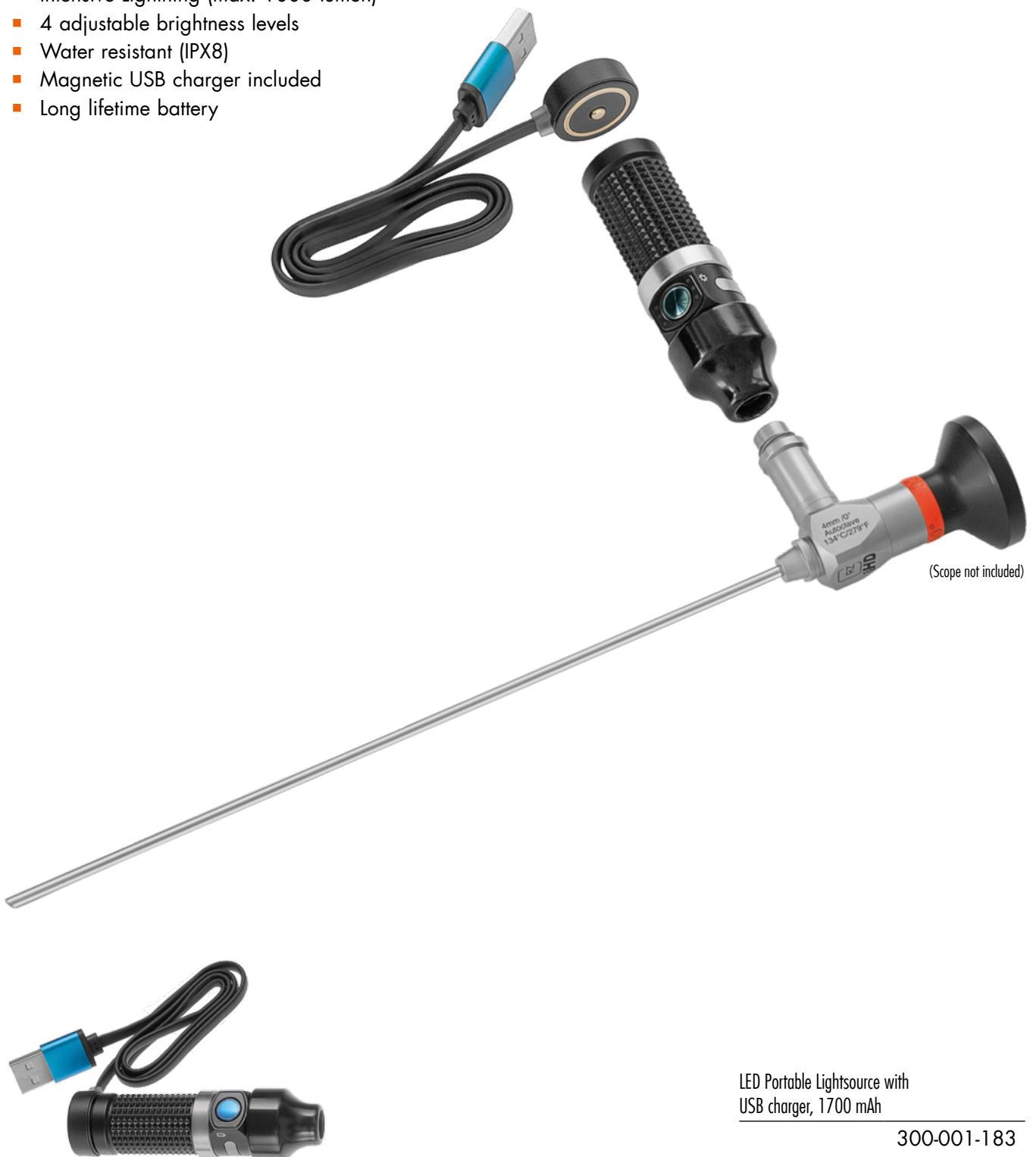

300-001-183



OP Headlight, black head band,
super light-weight, leather padded FO cable
bifurcated, top headbandg

100-102-100



Head Light with light cable for use with all
common light sources,
with leather pad at silicone band

100-103-100



LED Head light with Li-Ion battery,
head band with stepless regulation wheel,
including charger

100-103-400

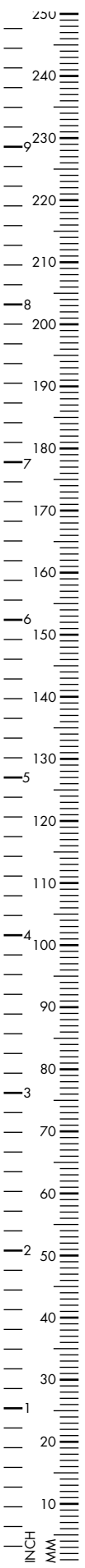



Flexible Arm, complete with holding rod,
without rotating clamp

A 251-010-000

Rotating clamp for flexible tension arm
attachable to operating table

B 251-010-100

Aural Specula Holder for flexible arm

C 251-010-200

Endoscope Clamp for flexible arm

D 251-010-300



SHEA

Ear Speculum Holder

410-900-000

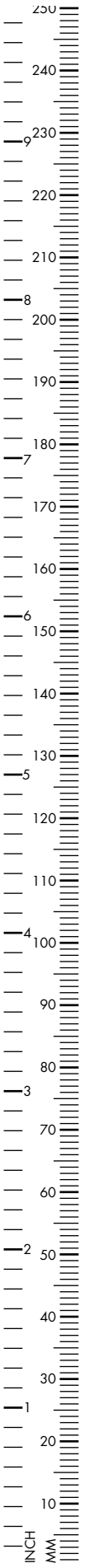

POLITZER

Aural Speculum, round, straight, 27mm length, stainless steel, for children

inner Ø 2.0mm	410-009-003
inner Ø 3.0mm	410-009-004
inner Ø 4.0mm	410-009-005
inner Ø 5.0mm	410-009-006



HARTMANN

Aural Speculum, round, straight, 27mm length, for children

inner Ø 3.0mm	410-019-003
inner Ø 4.0mm	410-019-004
inner Ø 5.0mm	410-019-005



TOYNBEE

Ear Speculum, stainless steel, round, straight, 36mm

inner Ø 3mm	410-014-004
inner Ø 4mm	410-014-005
inner Ø 5mm	410-014-006
inner Ø 6.5mm	410-014-007



HARTMANN

Aural Speculum, round, straight, 36mm length, for adults

outer Ø 3.0mm	410-019-030
outer Ø 4.0mm	410-019-040
outer Ø 5.0mm	410-019-050
outer Ø 6.0mm	410-019-060
outer Ø 7.5mm	410-019-075

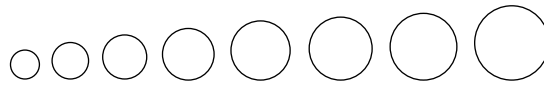
**BOUCHERON**

Ear Speculum, round, straight

30mm inner Ø 3.0mm	410-018-004
32mm inner Ø 3.5mm	410-018-005
34mm inner Ø 4.5mm	410-018-006
35mm inner Ø 5.1mm	410-018-007
35mm inner Ø 5.5mm	410-018-008
35mm inner Ø 6.5mm	410-018-009
36mm inner Ø 7.5mm	410-018-010
37mm inner Ø 9.0mm	410-018-085

**FARRIOR**

Aural Speculum, round, 43mm length, straight, stainless steel

inner Ø 3.3mm outer Ø 4.1mm	410-022-001
inner Ø 4.3mm outer Ø 5.1mm	410-022-002
inner Ø 4.8mm outer Ø 5.6mm	410-022-003
inner Ø 5.3mm outer Ø 6.1mm	410-022-004
inner Ø 5.8mm outer Ø 6.6mm	410-022-005
inner Ø 6.3mm outer Ø 7.1mm	410-022-006
inner Ø 6.7mm outer Ø 7.5mm	410-022-007
inner Ø 7.2mm outer Ø 8.0mm	410-022-008
inner Ø 7.7mm outer Ø 8.5mm	410-022-009

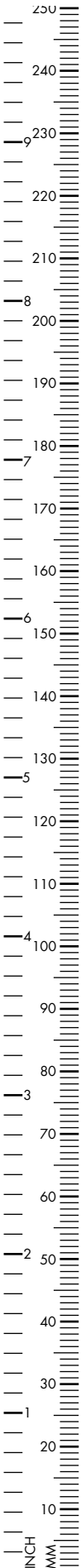

FARRIOR

Aural Speculum, round, 43mm length, straight, stainless steel

inner Ø 3.3mm	410-022-501
outer Ø 4.1mm	
inner Ø 4.3mm	410-022-502
outer Ø 5.1mm	
inner Ø 4.8mm	410-022-503
outer Ø 5.6mm	
inner Ø 5.3mm	410-022-504
outer Ø 6.1mm	
inner Ø 5.8mm	410-022-505
outer Ø 6.6mm	
inner Ø 6.3mm	410-022-506
outer Ø 7.1mm	
inner Ø 6.7mm	410-022-507
outer Ø 7.5mm	
inner Ø 7.2mm	410-022-508
outer Ø 8.0mm	
inner Ø 7.7mm	410-022-509
outer Ø 8.5mm	



FARRIOR

Oval, 20° oblique end, 43mm, stainless steel

inner Ø 3.0x4.0mm	410-023-001
outer Ø 3.8x4.8mm	
inner Ø 4.0x5.0mm	410-023-002
outer Ø 4.8x5.8mm	
inner Ø 4.5x5.5mm	410-023-003
outer Ø 5.3x6.3mm	
inner Ø 4.0x6.0mm	410-023-004
outer Ø 5.8x6.3mm	
inner Ø 5.5x6.5mm	410-023-005
outer Ø 6.3x7.3mm	
inner Ø 6.0x7.0mm	410-023-006
outer Ø 6.8x7.8mm	
inner Ø 6.5x7.5mm	410-023-007
outer Ø 7.3x8.3mm	
inner Ø 7.0x8.0mm	410-023-008
outer Ø 7.8x8.8mm	
inner Ø 7.5x8.5mm	410-023-009
outer Ø 8.3x9.3mm	



Oval, 20° oblique end, 43mm,
black finish

inner Ø 3.0x4.0mm outer Ø 3.8x4.8mm	410-023-501
inner Ø 4.0x5.0mm outer Ø 4.8x5.8mm	410-023-502
inner Ø 4.5x5.5mm outer Ø 5.3x6.3mm	410-023-503
inner Ø 5.0x6.0mm outer Ø 5.8x6.3mm	410-023-504
inner Ø 5.5x6.5mm outer Ø 6.3x7.3mm	410-023-505
inner Ø 6.0x7.0mm outer Ø 6.8x7.8mm	410-023-506
inner Ø 6.5x7.5mm outer Ø 7.3x8.3mm	410-023-507
inner Ø 7.0x8.0mm outer Ø 7.8x8.8mm	410-023-508
inner Ø 7.5x8.5mm outer Ø 8.3x9.3mm	410-023-509

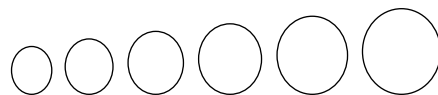

ZOELLNER

Oval, 20°, straight, 38mm, black finish

inner Ø 4.5x5.5mm outer Ø 5.5x6.5mm	410-132-001
inner Ø 5.5x6.5mm outer Ø 6.5x7.5mm	410-132-002
inner Ø 6.5x7.5mm outer Ø 7.5x8.5mm	410-132-003
inner Ø 7.5x8.5mm outer Ø 8.5x9.5mm	410-132-004
inner Ø 8.5x9.5mm outer Ø 9.5x10.5mm	410-132-005
inner Ø 9.5x10.5mm outer Ø 10.5x11.5mm	410-132-006

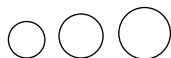

HOLMGREN

Self retaining, black finish

inner Ø 4mm outer Ø 5mm	410-032-050
inner Ø 5mm outer Ø 6mm	410-032-060
inner Ø 6mm outer Ø 7mm	410-032-070



SCHWABER

Specula with hinge, 165mm, 6¹/₂"

30mm blades 170-786-030

50mm blades 170-786-050

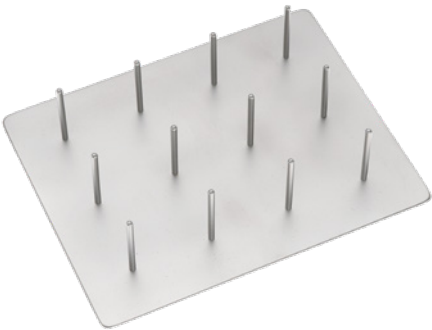

Rack for 12 ear specula

111 x 83 x 37 mm 410-012-110



BRUENINGS

Aural magnifier, anastigmatic, complete with:
1 diagnostic head 410-150-007, 1 operating
head, 6 ear specula, 1 rubber tube and
connection cone 410-150-008

Set of 6 sizes

Ø 5.3mm 410-150-100

Ø 6.5mm

Ø 7.5mm

Ø 8.0mm

Ø 9.0mm

Ø 12.0mm

**HARTMANN**

Tuning Fork

c 128	410-185-010
c2 512	410-185-210
c4 2048	410-185-410
c1 256	410-185-110
c3 1024	410-185-310
c5 4096	410-185-510

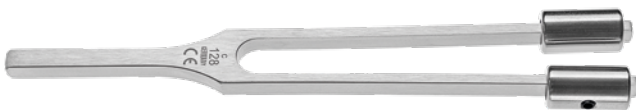
**HARTMANN**

Tuning Fork, with clamps

c 128	410-195-010
c1 256	410-195-110

**LUCAE**

Tuning Fork, with platform

c2 512	410-174-512
c3 1024	410-174-102



Tuning Fork, with platform

a1 440	410-190-440
--------	-------------

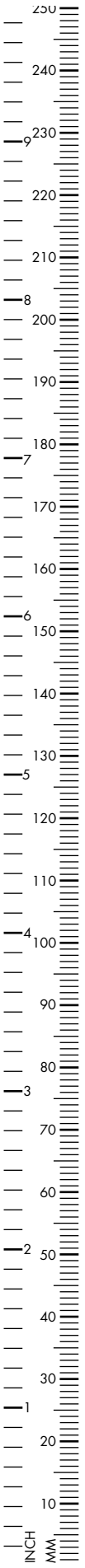

Aural Syringe, 10ml, all metal chromium plated, Luer-Lock attachment, consisting of:

Syringe, valve attachment, metal sinker, protection shield	410-800-100
Plastic tube, 600 mm outside 5mm, inside 2mm	410-800-020
Set with 4 tips	410-800-050
Complete set	410-800-000
Protection Shield	410-800-040
Metal Sinker	410-800-030
Valve Attachment	410-800-010

Ear Syringe, all metal, with conical and bulbous pipe

50ml	410-797-050
75ml	410-797-075
125ml	410-797-125



HARTMANN

Eustachian Catheter

Ø 2.0mm	410-276-072
Ø 2.5mm	410-276-074
Ø 3.0mm	410-276-076
Ø 3.5mm	410-276-078
Ø 4.0mm	410-276-080



WILLIAMS

Eustachian Catheter

	410-276-020
--	-------------

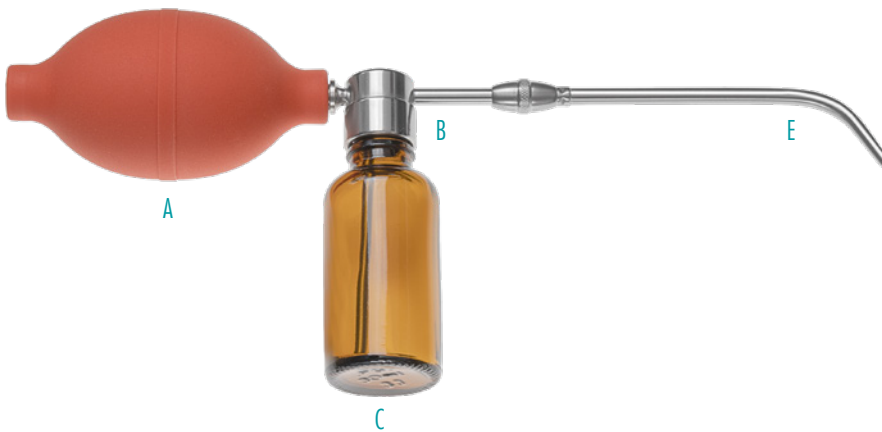

Atomizer, complete with 3 metal tips and rubber bulb

	410-205-000
--	-------------

Rubber bulb

A	410-205-100
---	-------------

Metal mounting

B	410-205-200
---	-------------

Spare bottle, 30ccm

C	410-205-300
---	-------------

Aural Cannula, straight tip, 100mm, 4"

D	410-205-001
---	-------------

Aural Cannula, curved tip, 125mm, 5"

E	410-205-002
---	-------------

Flushing Needle

F	410-797-200
---	-------------



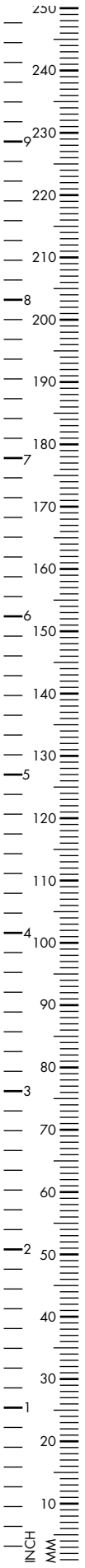

STACKE

Aural Probe, ring handle
 Ø 0.8mm

100mm, 5 1/2" 160-131-105

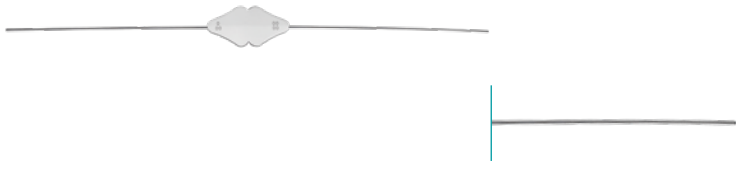

BOWMAN

Lacrimal Probe, buttoned up

0000/000	400-497-008
00/0	400-497-003
0/1	400-497-001
1/2	400-497-012
2/3	400-497-023
3/4	400-497-034
4/5	400-497-045
5/6	400-497-056
6/7	400-497-067
7/8	400-497-078



PICCOLO

Applicator, slender, round
 Ø 0.7mm

110mm, 4 1/2" 160-420-110



FARRELL

Applicator, round serrated end
 Ø 0.9mm

140mm, 5 1/2" 160-422-140

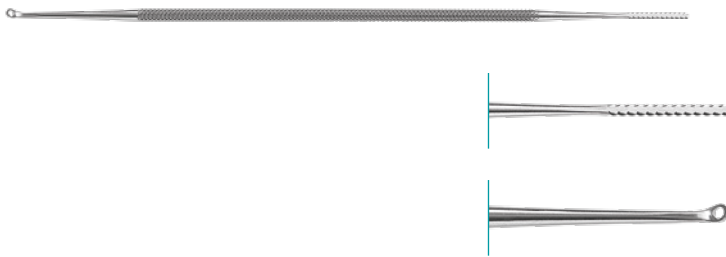

JOBSON-HORNE

Aural Probe, double-ended,
smooth ring and serrated end

180mm, 7" 160-255-180

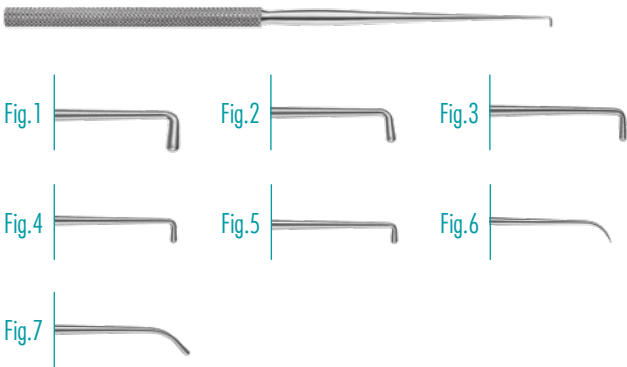

WAGENER

Hooklet, probe-ended, 140mm, 5^{1/2}"

Fig. 1	410-585-001
Fig. 2	410-585-002
Fig. 3	410-585-003
Fig. 4	410-585-004
Fig. 5	410-585-005
Fig. 6	410-585-006
Fig. 7	410-585-007



DAY

Ear Hook, 160mm, 6^{1/4}"

Fig. 1	410-584-001
Fig. 2	410-584-002

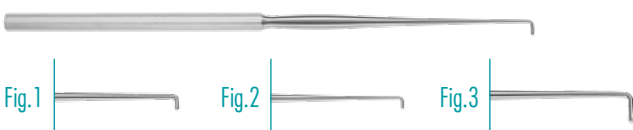

LUCAS

Ear Hook, probe-ended, 140mm, 5^{1/2}"

Fig. 1	410-586-141
Fig. 2	410-586-142
Fig. 3	410-586-143

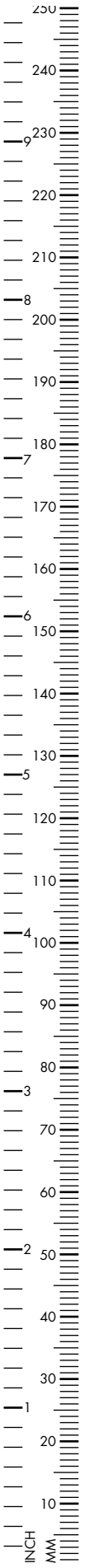

ZAUFAL-JANSEN

Aural hook, probe ended, 45° angled

150mm, 6" 410-583-150



ZAUFAL

Ear Leaver

160mm, 6 1/4" 410-583-145

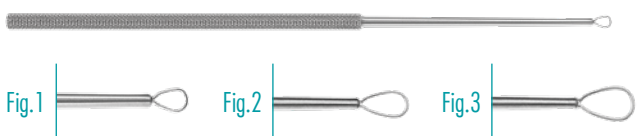

BILLEAU

Aural Loop, straight, 160mm, 6 1/4"

Fig. 1 410-580-001

Fig. 2 410-580-002

Fig. 3 410-580-003

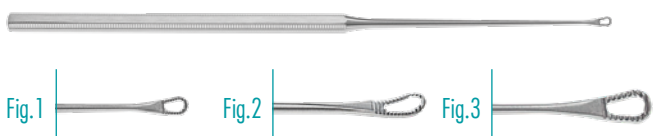

SNELLEN (WEBER-LOCH)

Aural Loop, curved, serrated, 160mm, 6 1/4"

Fig. 1 410-580-161

Fig. 2 410-580-162

Fig. 3 410-580-163



LANGENBECK

Aural loop, blunt, slightly curved

130mm, 5^{1/8}" 410-580-130



BUCK

Aural Curette, 150mm, 6"
straight, blunt

Fig. 000, Ø 0.7mm 410-100-300

Fig. 00, Ø 1.2mm 410-100-000

Fig. 0, Ø 1.5mm 410-100-001

Fig. 1, Ø 2.0mm 410-100-002

Fig. 2, Ø 2.4mm 410-100-003

Fig. 3, Ø 2.7mm 410-100-004

straight, sharp

Fig. 000, Ø 0.7mm 410-101-300

Fig. 00, Ø 1.2mm 410-101-000

Fig. 0, Ø 1.5mm 410-101-001

Fig. 1, Ø 2.0mm 410-101-002

Fig. 2, Ø 2.4mm 410-101-003

Fig. 3, Ø 2.7mm 410-101-004

curved, blunt

Fig. 000, Ø 0.7mm 410-102-300

Fig. 00, Ø 1.2mm 410-102-000

Fig. 0, Ø 1.5mm 410-102-001

Fig. 1, Ø 2.0mm 410-102-002

Fig. 2, Ø 2.4mm 410-102-003

Fig. 3, Ø 2.7mm 410-102-004

curved, sharp

Fig. 000, Ø 0.7mm 410-103-300

Fig. 00, Ø 1.2mm 410-103-000

Fig. 0, Ø 1.5mm 410-103-001

Fig. 1, Ø 2.0mm 410-103-002

Fig. 2, Ø 2.4mm 410-103-003

Fig. 3, Ø 2.7mm 410-103-004

Fig.000



Fig.00



Fig.0



Fig.1



Fig.2



Fig.3



straight



curved



blunt



sharp



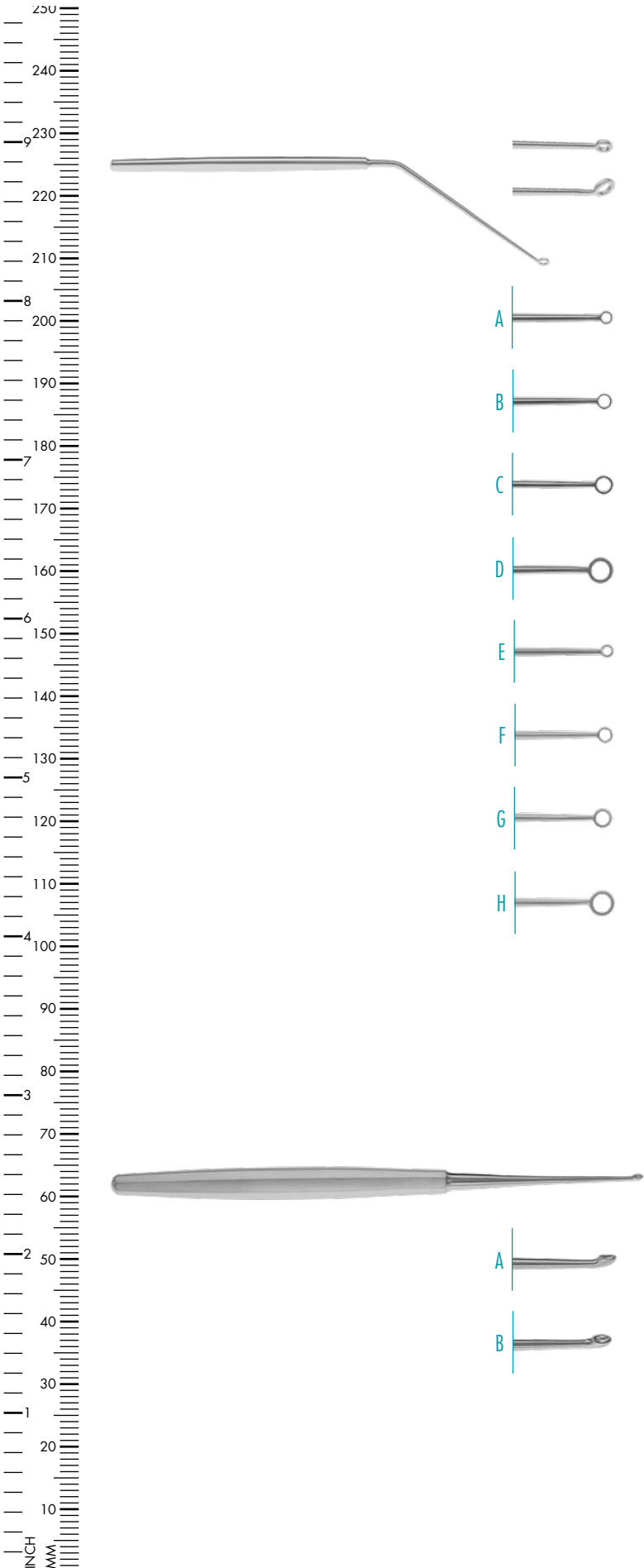

Ear Curette, angled shaft, blunt, 140mm, 5¹/₂" straight ring

A Fig. 0	410-105-000
B Fig. 1	410-105-001
C Fig. 2	410-105-002
D Fig. 3	410-105-003

35° upwards angled

E Fig. 0	410-105-350
F Fig. 1	410-105-351
G Fig. 2	410-105-352
H Fig. 3	410-105-353

Ear Canal Curette, sharp, 170mm, 6²/₃"

A Fig. 1, 1.8mm	410-108-001
B Fig. 2, 2.1mm	410-108-002

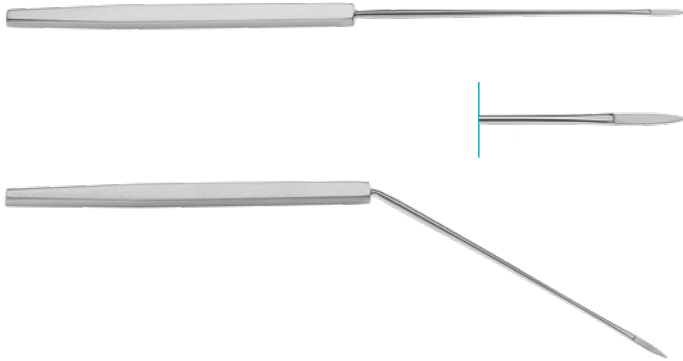

POLITZER

Ear Knife, straight

160mm, 6¹/₄" 410-034-160

curved

160mm, 6¹/₄" 410-035-160

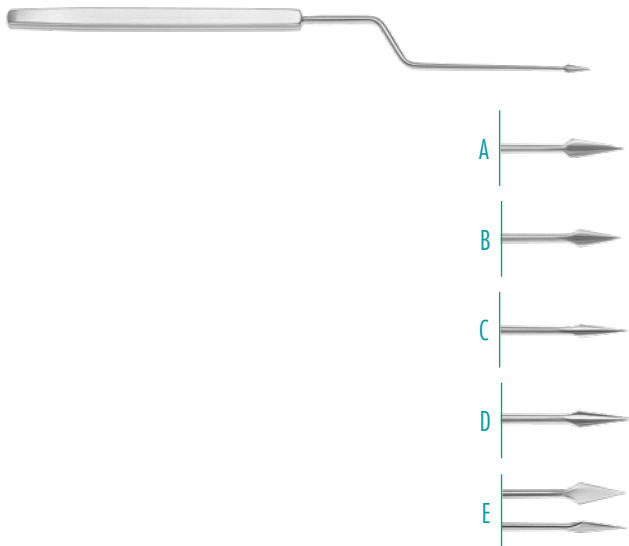

LUCAE

Tympanum Perforator, bayonet shape,
for children, 180mm, 7"

A 1.5 x 3mm 410-031-180

for adults, 190mm, 7¹/₂"

B 2.0mm 410-032-180

C 1.8mm 410-032-182

D 1.5mm 410-032-181

for adults, horizontal shape

E 410-033-180



POLITZER

Tympanum Perforator, knee bent,
160mm working length

vertical 410-032-160

horizontal 410-033-160

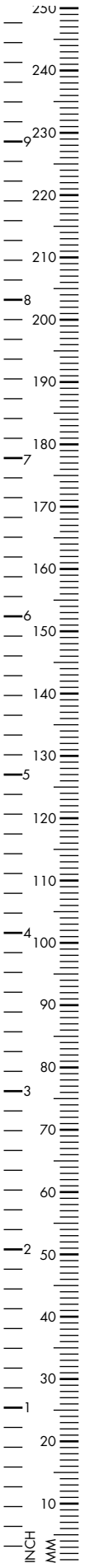

LUCAE

Aural Dressing Forceps, bayonet shaped

140mm, 5¹/₂"

410-391-140



TROELTSCH

Aural Dressing Forceps, delicate, small, serrated, 45mm working length

100mm, 4¹/₃"

410-375-100

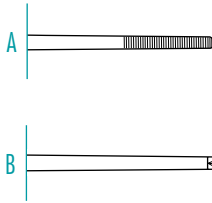

WILDE-TROELTSCH

Aural Dressing Forceps, 120mm, 4³/₄"

A serrated

410-375-120

B 1 x 2 teeth

410-377-120

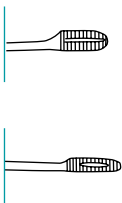

HARTMANN

Aural Tampon Forceps, strong pattern

120mm, 4³/₄"

410-230-140

delicate pattern

135mm, 5¹/₃"

410-230-120

**HARTMANN**

Ear Forceps, straight,
80mm working length

1.0 x 8.0mm	410-210-085
-------------	-------------

125mm working length

1.0 x 4.5mm	410-210-125
-------------	-------------

**DUCKBILL**

Ear Forceps, 80mm working length, straight

8mm, serrated	410-338-139
---------------	-------------

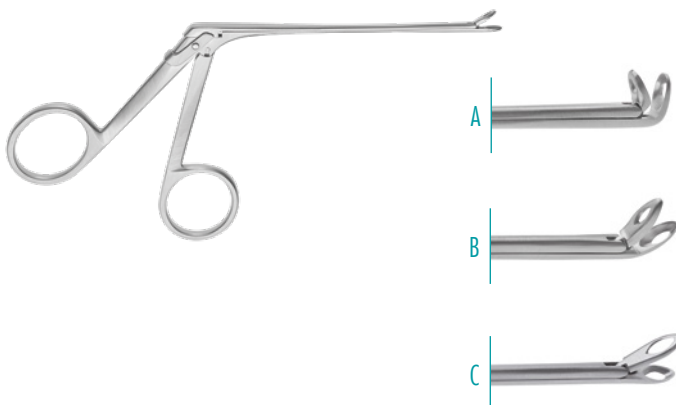
**STRUEMPEL**

Ear Forceps, 80mm working length

A 2.5 x 6.0mm, 90° upwards	410-338-132
-------------------------------	-------------

B 2.5 x 6.0mm, 45° upwards	410-338-133
-------------------------------	-------------

C 2.5 x 7.0mm, straight	410-338-134
----------------------------	-------------

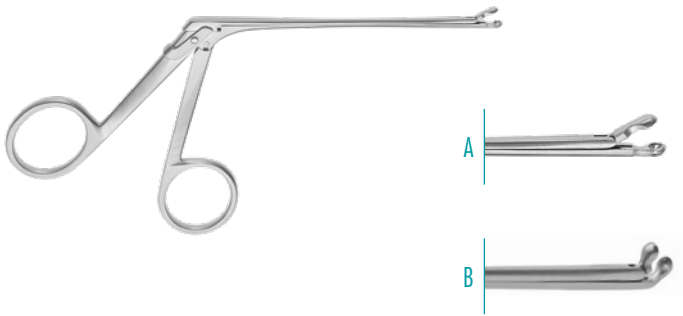
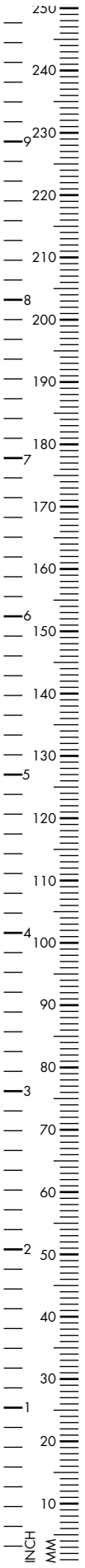

HARTMANN-HERZFELD

Ear Forceps, 80mm working length,

A straight

1.0mm spoon	410-338-131
2.0mm spoon	410-338-135
2.5mm spoon	410-338-136
3.0mm spoon	410-338-140

B curved upwards

2.0mm spoon	410-338-142
-------------	-------------

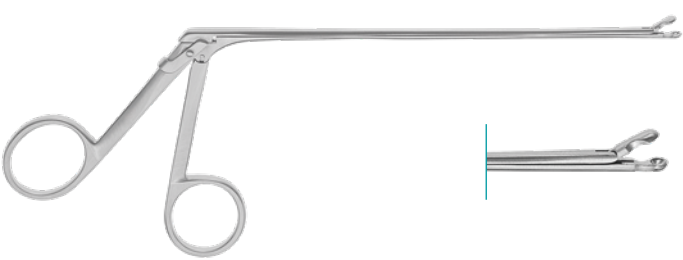

HARTMANN-HERZFELD

Ear Forceps, 125mm working length

2.0mm spoon	410-338-125
-------------	-------------

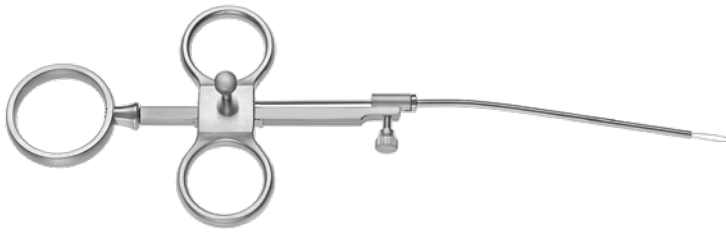
**KRAUSE**

Ear Polypus Snare

165mm, 6¹/₂"

410-410-160

**KRAUSE**

Aural Snare Wire, package of 100 pcs.

Ø 0.2mm

410-411-100

**MUCK**

Periosteal Knife

150mm, 6"

210-394-150

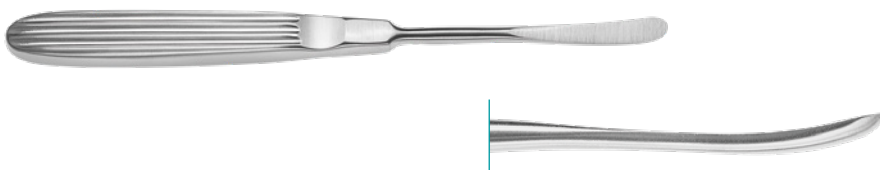
**OBWEGESER**Periosteal Elevator, 175mm, 6⁷/₈"

6mm

431-630-006

7mm

431-630-007

9mm

431-630-009

11mm

431-630-011

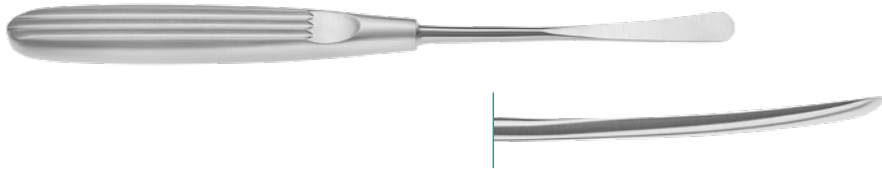
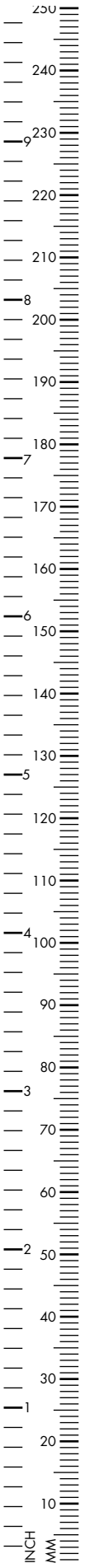

JANSEN

Raspatory, 195mm, 7²/₃"

9mm	431-629-009
11mm	431-629-011
14mm	431-629-014
16mm	431-629-016

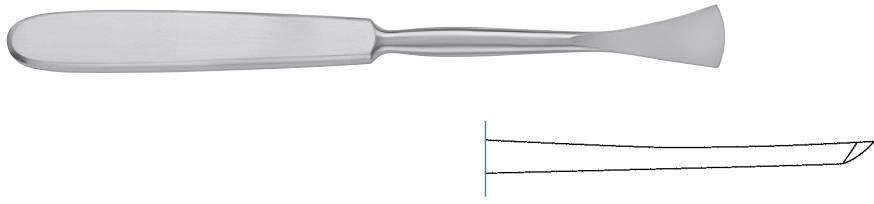

LANGENBECK

Raspatory, 16mm, hollow handle

190mm, 7 ¹ / ₂ "	210-303-190
--	-------------

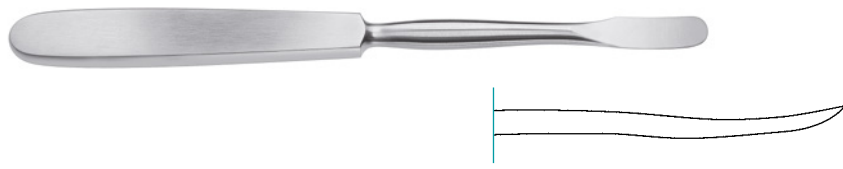

KRAEMER

Raspatory, 10mm, round blade

185mm, 7 ¹ / ₄ "	210-313-185
--	-------------

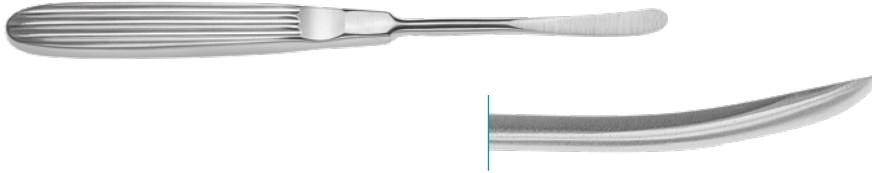
**OBWEGESER**Periosteal Elevator, curved, 175mm, 6⁷/₈"

7mm 431-630-007

9mm 431-630-009

11mm 431-630-011

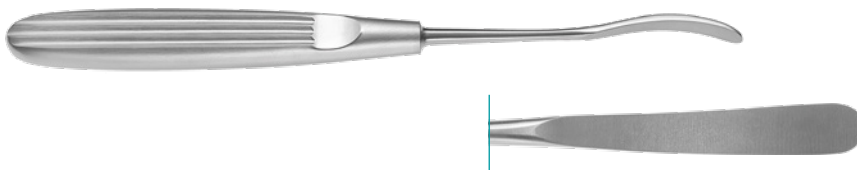
**EICKEN**

Periosteal Elevator

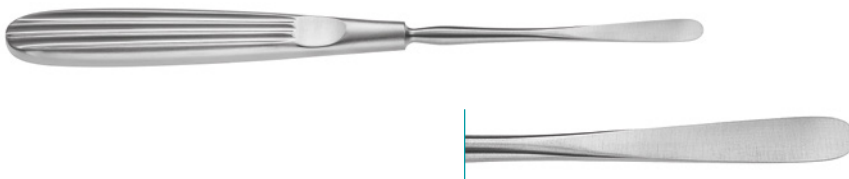
195mm, 7²/₃" 431-636-195**ERLANGEN**

Raspatory, 6mm wide, slightly curved

175mm, 6⁷/₈" 420-547-006

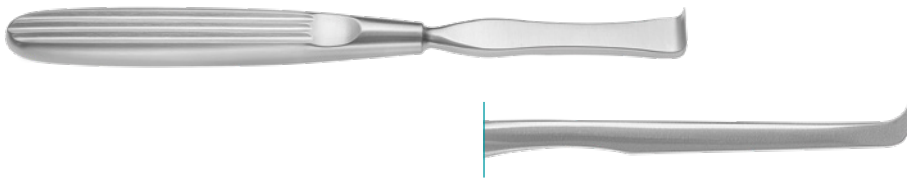
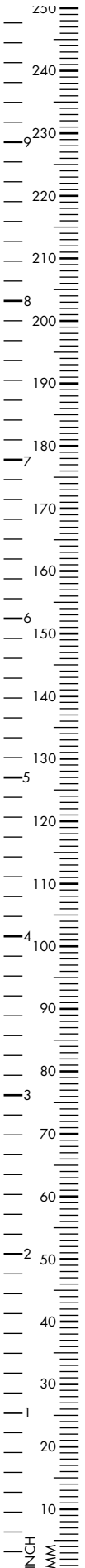

FARABEUF
 Periosteal Elevator, 11mm, curved
 180mm, 7" 210-311-180

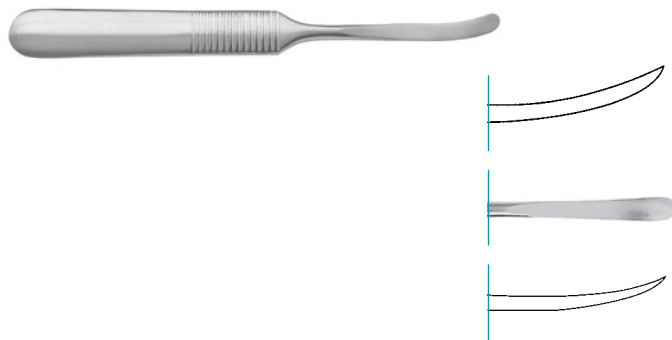

WILLIGER
 Raspatory, 4mm
 130mm, 5¹/₈" 210-434-130
 160mm, 6¹/₄"
 5mm 210-436-160
 7mm 210-438-160



TRAUTMANN
 Gouge, 140mm, 5¹/₂"
 3mm 210-113-143
 5mm 210-113-145
 7mm 210-113-147
 9mm 210-113-149



TRAUTMANN
 Chisel, 140mm, 5¹/₂"
 3mm 210-114-143
 5mm 210-114-145
 7mm 210-114-147
 9mm 210-114-149

**COTTLE**

Mallet, Ø 30mm, 1 side plain, 1 side convex
240g

190mm, 7^{1/2}" 210-240-180

**LUCAE**

Mallet, Ø 19mm
190mm, 7^{1/2}"

80g 210-230-190

140g 210-231-190

**COLLIN (LUCAE)**

Mallet, Ø 30mm
220g

200mm, 8" 210-220-200

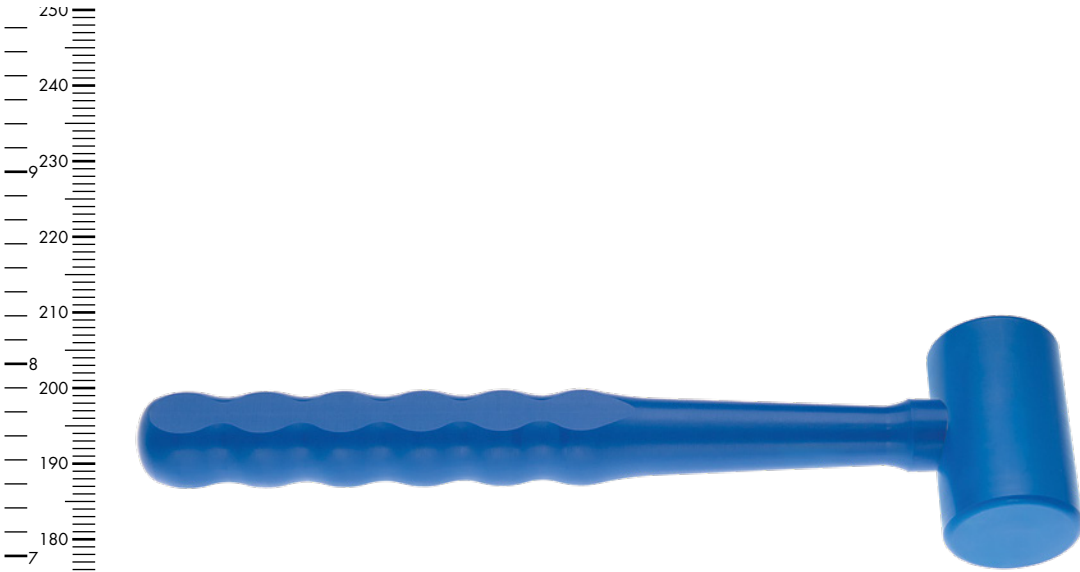

Mallet, Ø 35mm, synthetic
 240mm, 9¹/₂" 210-260-150

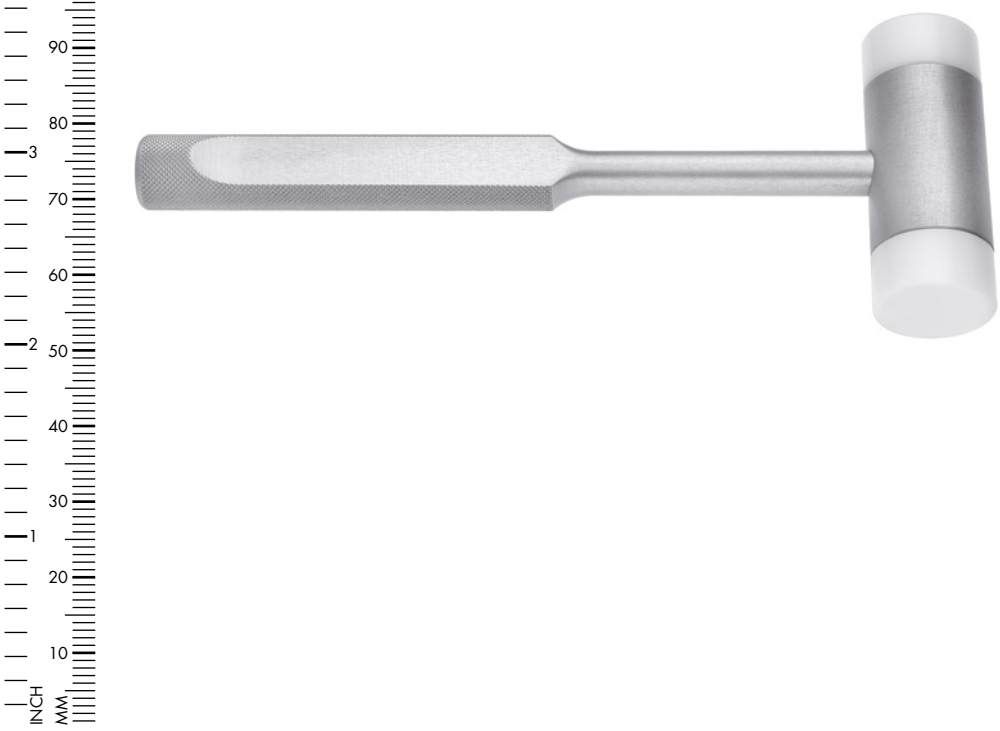

Mallet, anodized aluminium handle and head,
 Ø 32mm
 140g
 225mm, 8⁷/₈" 210-264-220
 Spare Discs, pair 210-264-221

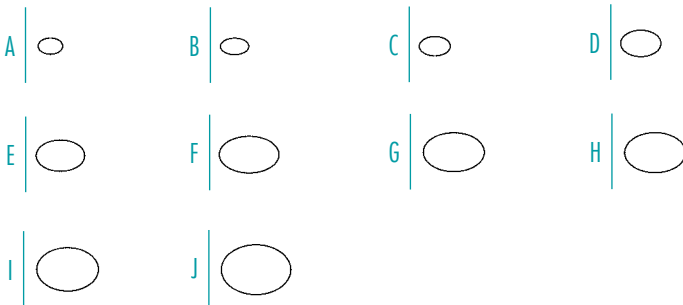

SPRATT

Bone Curette, oval, 170mm, 6²/₃"

A	#0000, 2.5mm	210-308-008
B	#000, 3.0mm	210-308-000
C	#00, 4.0mm	210-308-001
D	#0, 4.5mm	210-308-002
E	#1, 5.0mm	210-308-003
F	#2, 6.0mm	210-308-004
G	#3, 7.0mm	210-308-005
H	#4, 8.0mm	210-308-006
I	#5, 9.6mm	210-308-007
J	#6 11.5mm	210-308-009

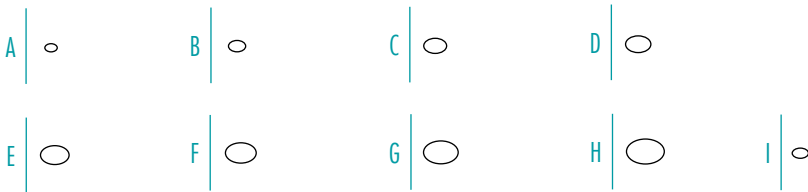

LEMPERT

Bone Curette, 200mm, 8"

A	#000000, 1mm	210-348-600
B	#00000, 1.5mm	210-348-500
C	#0000, 2.0mm	210-348-400
D	#000, 2.2mm	210-348-300
E	#00, 2.5mm	210-348-200
F	#0, 2.7mm	210-348-100
G	#1, 3.0mm	210-348-010
H	#2, 3.3mm	210-348-002
I	#1, 1.8mm	210-348-001

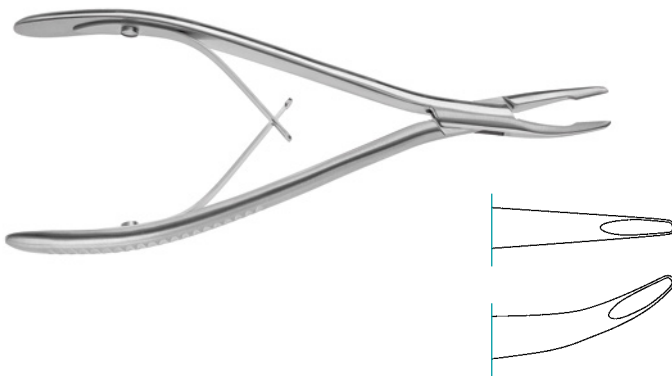
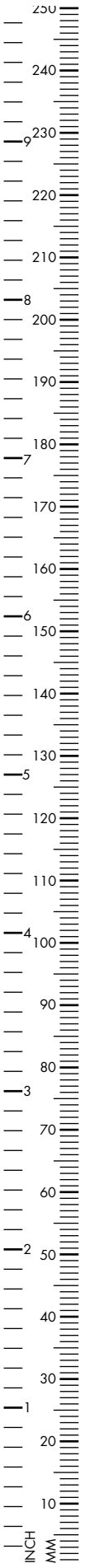

LEMPERT

Bone Rongeur, 160mm, 6¹/₄"

straight	210-770-160
curved	210-771-160

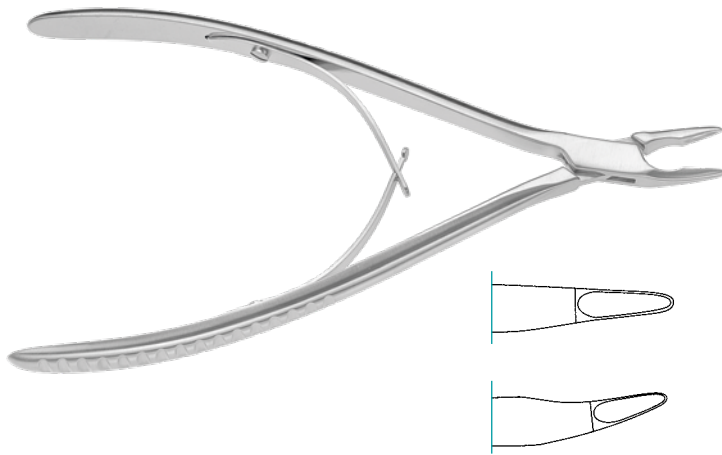

LEMPERT

Bone Rongeur, heavy pattern, 190mm, 7¹/₂"

straight	210-770-190
curved	210-771-190

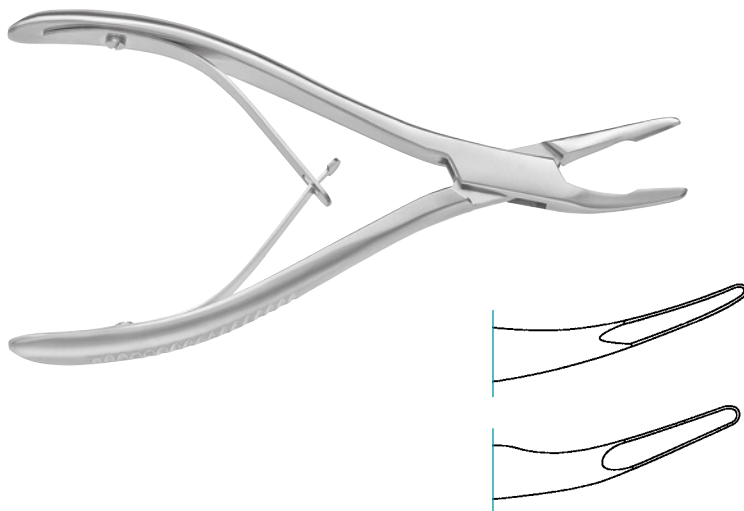

BEYER

Bone Rongeur, 3x16mm, 180mm, 7"

curved	210-830-180
strongly curved	210-831-180

**KERRISON**

Bone Punch, 90mm working length

3.0 x 9.0mm bite	410-245-000
------------------	-------------

85mm working length

4.0mm jaw	410-245-001
-----------	-------------

5.0mm jaw	410-245-002
-----------	-------------

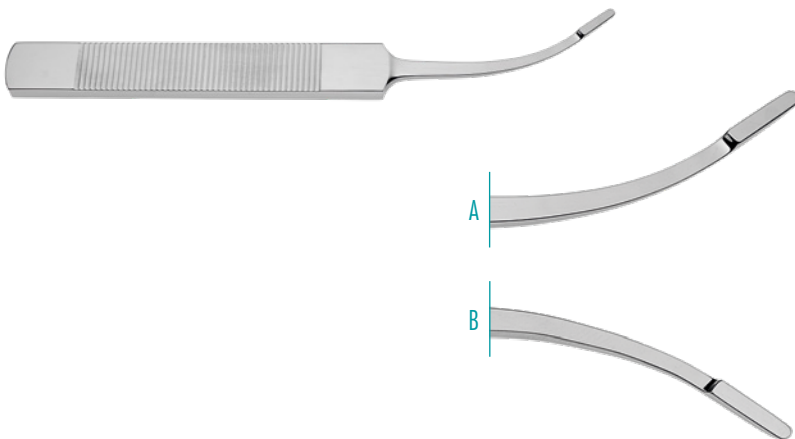
**STENSTROM**Ear Scraper, 160mm, 6¹/₄"

A curved left	410-033-130
---------------	-------------

B curved right	410-033-131
----------------	-------------

**DINGMANN**

Otobradars, left and right

160mm, 6 ¹ / ₄ "	410-033-100
--	-------------

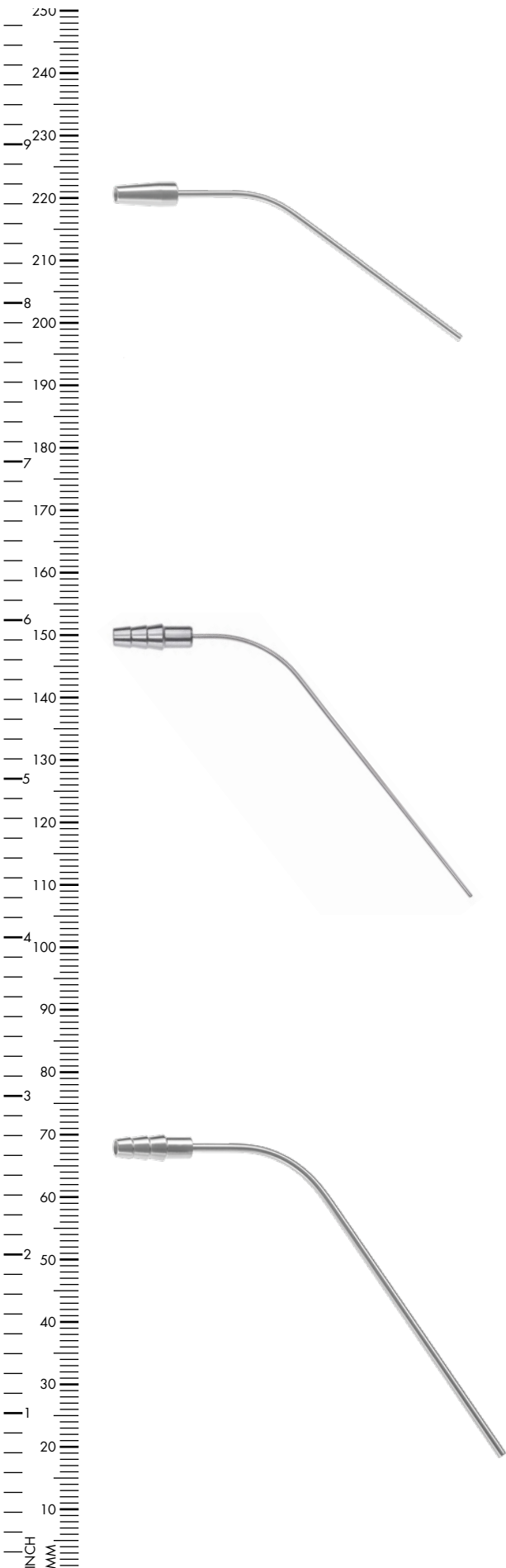

NIJMEGEN

Suction Tube, cylindrical with cone,
60mm working length

Ø 1.0mm	410-060-010
Ø 1.5mm	410-060-015
Ø 2.0mm	410-060-020
Ø 2.5mm	410-060-025
Ø 3.0mm	410-060-030
Ø 4.0mm	410-060-040

Suction Tube, knee bent,
90mm working length

Ø 1.0mm	410-090-010
Ø 1.5mm	410-090-015
Ø 2.0mm	410-090-020
Ø 3.0mm	410-090-030
Ø 4.0mm	410-090-040
Ø 5.0mm	410-090-050

Suction Tube, knee bent,
110mm working length

1.0mm	410-090-110
1.5mm	410-090-115
2.0mm	410-090-120
2.5mm	410-090-125
3.0mm	410-090-130
4.0mm	410-090-140
5.0mm	410-090-150



Suction Tube, malleable,
175mm working length

Ø 3.0mm 410-225-003



FERGUSSON

Suction tube, finger cut-off, stylet, Luer hub,
130mm, 5¹/₈"

Ø 1.5mm 165-625-005

Ø 2.0mm 165-625-006

Ø 2.5mm 165-625-008

Ø 3.0mm 165-625-010

Ø 4.0mm 165-625-012

Ø 5.0mm 165-625-015

180mm, 7"

Ø 1.5mm 165-525-005

Ø 2.0mm 165-525-006

Ø 2.5mm 165-525-008

Ø 3.0mm 165-525-010

Ø 4.0mm 165-525-012

Ø 5.0mm 165-525-015

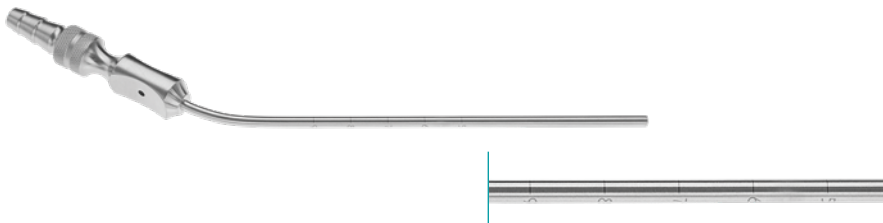

FRAZIER

Suction Tube, 100mm working length,
with length marking

5 Charr. 165-523-105

7 Charr. 165-523-107

9 Charr. 165-523-109



PLESTER

Suction Tube, 140mm working length

5 Charr. 165-725-005

7 Charr. 165-725-007

8 Charr. 165-725-008

9 Charr. 165-725-009

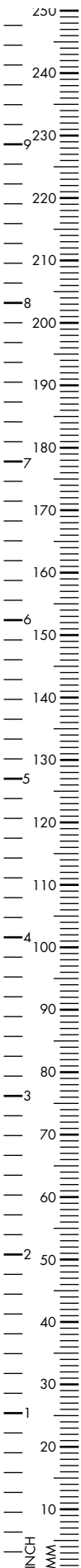
**HOUSE**

Suction Cannula, finger cut-off and stylet,
90mm, 3¹/₂"

Ø 0.9mm / Ø 0.7mm	252-140-003
Ø 1.2mm / Ø 0.9mm	252-140-004
Ø 1.5mm / Ø 1.2mm	252-140-005
Ø 1.5mm / Ø 1.8mm	252-140-006
Ø 2.5mm / Ø 2.0mm	252-140-007
Ø 3.0mm / Ø 2.0mm	252-140-008
Ø 4.5mm / Ø 2.0mm	252-140-009

WULLSTEIN

Suction Cannula, cylindrical, silver plated,
with stylet, olive with Luer hub, 160mm, 6¹/₄"

Ø 1.5mm	410-135-160
Ø 2.0mm	410-132-160
Ø 3.0mm	410-133-160

VERHOEVEN

Suction Cannula, straight,
100 mm working length

Ø 2.0mm	410-134-320
Ø 1.5mm	410-134-316
Ø 1.2mm	410-134-312

**VERHOEVEN**

Suction Tube, 100mm working length

Ø 2.0mm

curved up 410-134-120

curved down 410-134-220

110mm working length

Ø 1.6mm

curved up 410-134-116

curved down 410-134-216

**TALESHI**

Suction, 3 Charr.

40° upwards 410-133-143

40° downwards 410-133-243

70° upwards 410-133-173

70° downwards 410-133-273

5 Charr.

40° upwards 410-133-145

40° downwards 410-133-245

70° upwards 410-133-175

70° downwards 410-133-275

**BARON**

Suction Tube, finger cut-off, stylet,

75mm, 3"

3 Charr. 165-538-003

5 Charr. 165-538-005

7 Charr. 165-538-007

100mm, 4"

3 Charr. 165-539-003

5 Charr. 165-539-005

7 Charr. 165-539-007

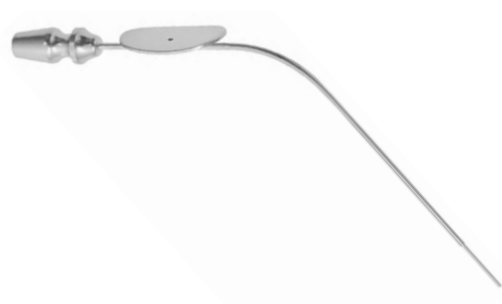
**SCHUKNECHT**Suction Tube, 135mm, 5¹/₃"

Ø 0.6mm 165-536-006

Ø 0.7mm 165-536-007

Ø 0.9mm 165-536-009

Ø 1.0mm 165-536-010

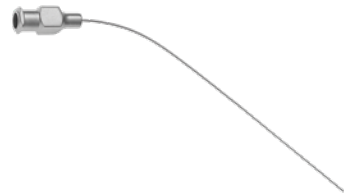
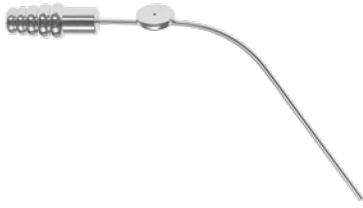
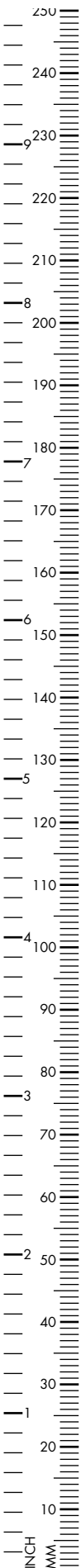
**BARNES**

Suction Tube, 50mm working length

Ø 1.5mm	410-150-015
Ø 1.7mm	410-150-017
Ø 2.0mm	410-150-020

HOUSE

Suction Adapter, finger cut-off, olive: Ø 7mm

51mm, 2 ¹ / ₈ "	420-195-000
---------------------------------------	-------------

WULLSTEIN

Aural Suction Handle, finger cut-off, Luer cone

	420-196-000
--	-------------

HOUSEAural Suction Cannula with Luer cone,
set with 2 pieces

Ø 0.5mm	420-196-005
Ø 0.6mm	420-196-006
Ø 0.7mm	420-196-007
Ø 0.8mm	420-196-008
Ø 0.9mm	420-196-009
Ø 1.0mm	420-196-010
Ø 1.2mm	420-196-012
Ø 1.5mm	420-196-015
Ø 2.0mm	420-196-020
Ø 2.5mm	420-196-025

**ROSEN**Suction Cannula, angled,
65mm working length

GA 9	Ø 3.0mm	410-133-005
GA 10	Ø 2.5mm	410-133-006
GA 13	Ø 2.2mm	410-133-007
GA 14	Ø 2.0mm	410-133-008
GA 15	Ø 1.8mm	410-133-009
GA 16	Ø 1.6mm	410-133-010
GA 17	Ø 1.5mm	410-133-013
GA 18	Ø 1.2mm	410-133-015
GA 19	Ø 1.0mm	410-133-018
GA 20	Ø 0.9mm	410-133-020
GA 21	Ø 0.8mm	410-133-025
GA 22	Ø 0.7mm	410-133-030
GA 24	Ø 0.6mm	410-133-035
GA 26	Ø 0.5mm	410-133-040

**VERHOEVEN**

Suction Tube, 60mm working length

Ø 1.6mm	410-134-016
Ø 1.2mm	410-134-012
Ø 0.9mm	410-134-009
Ø 0.7mm	410-134-007
Ø 0.6mm	410-134-006

Suction Tube, malleable,
80mm working length

Ø 0.5mm	410-138-005
Ø 0.7mm	410-138-007
Ø 1.0mm	410-138-010
Ø 1.2mm	410-138-012
Ø 1.5mm	410-138-015
Ø 2.0mm	410-138-020
Ø 2.5mm	410-138-025
Ø 3.0mm	410-138-030

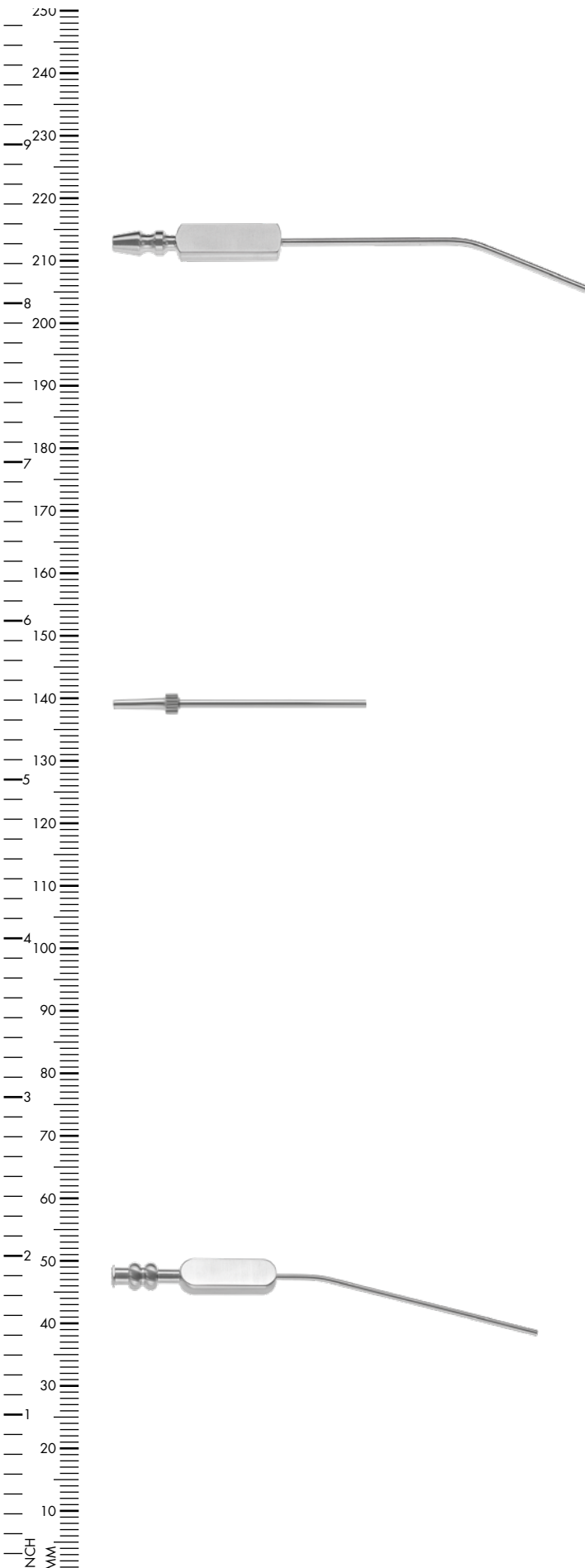
**ZOELLNER**

Suction Tube, s/s, tube with stilette,
175mm, 6⁷/₈"

Ø 8mm olive	410-267-100
Ø 8mm olive, with suction hole	410-267-101

ZOELLNER

Suction Tip, 55mm, 10 pcs. per package

Ø 1.2mm / 18swg	410-267-012
Ø 0.9mm / 20swg	410-267-009
Ø 0.8mm / 21swg	410-267-008
Ø 0.7mm / 22swg	410-267-007
Ø 0.6mm / 24swg	410-267-006
Ø 0.5mm / 25swg	410-267-005
Ø 0.4mm / 26swg	410-267-004

FISCH

Suction Tube, 145mm working length

Ø 1.2mm	410-269-012
Ø 1.5mm	410-269-015
Ø 2.0mm	410-269-020
Ø 2.2mm	410-269-022
Ø 2.5mm	410-269-025
Ø 3.0mm	410-269-030
Ø 5.0mm	410-269-050

EESy

The **EESy** instruments allows the surgeon to use the one-hand technique. The instruments are a suction – cutting – dissection combination. These gives you major benefits in ESS and reduce the limitations of the endoscopic approach.

With the **EESy** you have one hand for the scope and the other for the instrument. You avoid the constant change of instruments and suction devices.

With **EESy** Instruments, surgeons can choose between two ergonomic concepts—SoftGrip for enhanced handling comfort and Pure for a streamlined all-steel experience. Both systems are engineered to support precision and control in endoscopic ear surgery.

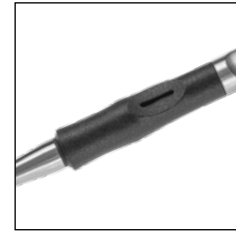

SoftGrip



Pure



Benefits:

- Different tips in one design keeps your handling consistent
- Mini working tips combines with suction cannulas
- Less blood or tissue parts in the field of view
- Instrument can be kept in the surgical field

EESy Endoscopic Ear Instruments

A 130mm working length SoftGrip

B 135mm working length Pure



Dissector, single curved,
3.0mm / 6.2mm, left

A 410-880-001

B 410-880-501



Dissector, single curved,
3.0mm / 6.2mm, right

A 410-880-002

B 410-880-502



Dissector, single curved,
0.6mm, Ø 1.0mm suction channel, left

A 410-880-003

B 410-880-503



Dissector, single curved,
0.6mm, Ø 1.0mm suction channel, right

A 410-880-004

B 410-880-504



Dissector, double curved,
3.0mm / 6.2mm, left

A 410-880-005

B 410-880-505



Dissector, double curved,
3.0mm / 6.2mm, right

A 410-880-006

B 410-880-506



Dissector
3.0mm / 6.2mm, left

A 410-880-007

B 410-880-507



Dissector
3.0mm / 6.2mm, right

A 410-880-008

B 410-880-508



Dissector
extra fine, left

A 410-880-009

B 410-880-509



Dissector
extra fine, right

A 410-880-010

B 410-880-510



Micro Hook
1.0mm/6.2mm, 45°

A 410-880-011



Micro Hook
1.5mm/6.2mm, 45°

A 410-880-012

B 410-880-512



Micro Hook
2.0mm/6.2mm, 45°

A 410-880-013

B 410-880-513

EESy Endoscopic Ear Instruments

A 130mm working length SoftGrip

B 135mm working length Pure

Round Knife
Ø 2.5mm/6.2mm, 45°

A 410-880-014

B 410-880-514

Round Knife
Ø 2.0mm/6.2mm, 45°

A 410-880-015

Round Knife
Ø 2.5mm/6.2mm, 45°

A 410-880-016

Knife, oval
2.5 x 3.5mm, left

A 410-880-017

B 410-880-517

Knife, oval
6.2mm, right

A 410-880-018

B 410-880-518

Sickle Knife
2.0mm, 35° curved

A 410-880-019

B 410-880-519

Curette
1.5 x 2.5mm, curved

A 410-880-020

Suction Finder
blunt

A 410-880-021

Suction Adaptor,
rotatable,
male, LuerLock

55° curved 410-880-000



Otoscope, Ø 3.0mm, 110mm

0°	410-130-000
30°	410-130-030
45°	410-130-045
70°	410-130-070

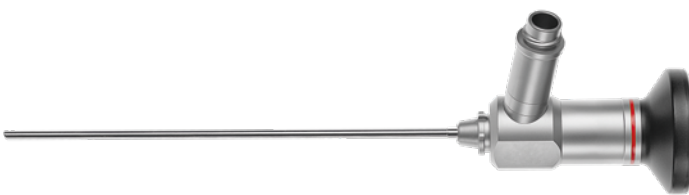

Ø 3.0mm, 140mm

0°	410-130-100
30°	410-130-130
45°	410-130-145
70°	410-130-170

Preyer Irrigation Tube for Endoscopic Ear Surgery

The irrigation tube is designed for intraoperative use during endoscopic ear surgery. It is guided alongside the endoscope to provide a controlled irrigation environment within the surgical field. Developed in collaboration with Prof. Dr. Preyer, the device addresses specific surgical needs observed in clinical practice.

The application of fluid plays a crucial role in the management of cholesteatoma, as the lesion becomes mobile under water and tends to rise. This behavior facilitates improved visualization and access, enabling more precise and efficient dissection. In combination with RZ **EESy** instruments, the irrigation tube supports atraumatic preparation and enhances surgical control, contributing to optimized procedural outcomes.

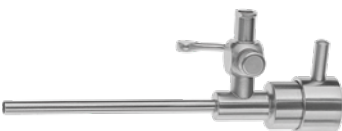

PREYER

Endoscope Irrigation Tube

for Ø 3.0mm, 110mm	410-880-356
for Ø 3.0mm, 140mm	410-880-387



Knife Handle #7
165mm, 6¹/₂" 110-130-077



Knife Handle #3
130mm, 5¹/₈" 110-110-003



WULLSTEIN
Raspatory
190mm, 7¹/₂" 410-329-190



BEALES
Raspatory, 165mm, 6¹/₂"
A 410-328-165
B spatula end 410-327-165

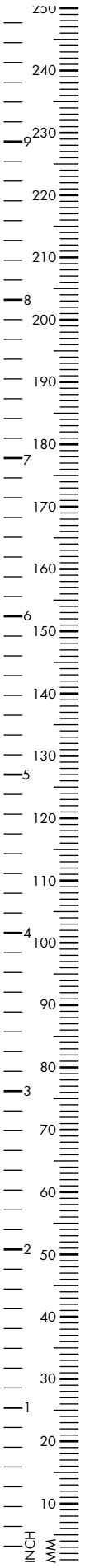

LEMPERT

Raspatory, narrow, 160mm, 6^{1/4}"

3mm	410-330-160
4mm	410-331-160



FISCH

Dura Elevator, 5mm

170mm, 6 ^{2/3} "	410-145-170
---------------------------	-------------



LEMPERT

Lempert Micro Ear Elevator,
slightly curved, 2mm

160mm, 6 ^{1/4} "	410-334-160
---------------------------	-------------

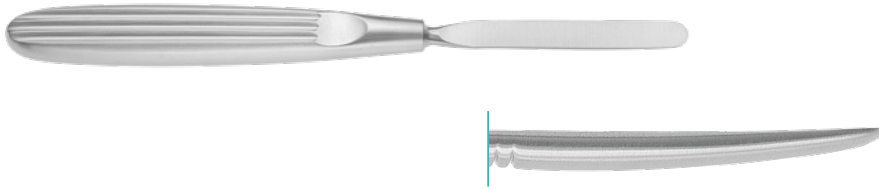
**PLESTER**

Raspatory, 180mm, 7"

8mm

410-146-180

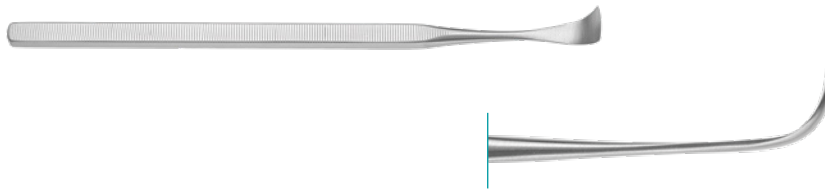
**FISCH**

Raspatory, 180mm, 7"

10mm

410-147-160

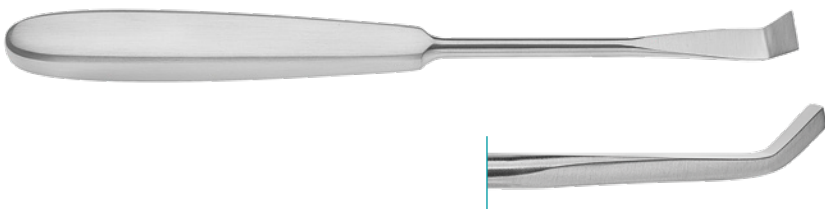

Periosteal Raspatory, 11mm

210mm, 8^{1/4}"

410-148-210

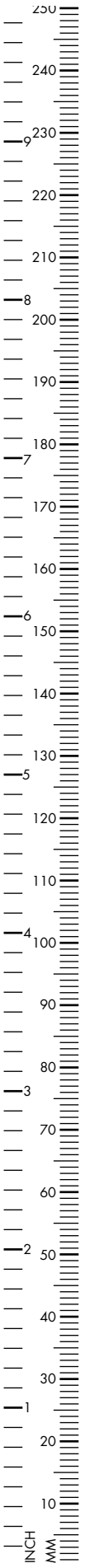

JANSEN

3x3 prongs, 100mm, 4"

sharp	170-720-100
blunt	170-723-100



BABY WEITLANER

2x3 teeth, 105mm, 4¹/₈"

sharp	170-748-105
blunt	170-749-105
semi-sharp	170-750-105



WEITLANER

3x4 teeth, sharp

165mm, 6 ¹ / ₂ "	170-750-165
200mm, 8"	170-750-200



WULLSTEIN

Self-retaining Retractor, 3x3 prongs, 110mm, 4¹/₃"

sharp	170-752-110
blunt	170-753-110



WULLSTEIN

Self-retaining Retractor, 3x3 prongs, 130mm, 5¹/₈"

sharp	170-752-130
blunt	170-753-130



BELLUCCI

Self-retaining Retractor, 3x3 sharp teeth, angled arms

	170-759-130
--	-------------

**PERKINS**Antrum Retractor, 130mm, 5¹/₈"

serrated blade on right side, 3 teeth left	170-765-135
--	-------------

serrated blade on left side, 3 teeth right	170-766-135
--	-------------

**ADSON ANDERSON**4x4 teeth, curved arms, 195mm, 7³/₄"

sharp	170-732-200
-------	-------------

blunt	170-733-200
-------	-------------

**RZ**Self-retaining Retractor, articulating joints, 3 x 3 prongs, 170mm, 6²/₃"

semi-sharp	170-780-170
------------	-------------

sharp	170-781-170
-------	-------------

blunt	170-782-170
-------	-------------

**RZ**Self-retaining Retractor, 165mm, 6¹/₂"

left blade full, right side 3 prongs	170-780-165
--------------------------------------	-------------

right blade full, left side 3 prongs	170-781-165
--------------------------------------	-------------

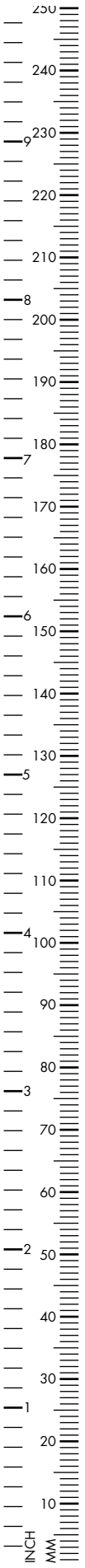

HOUSE

Self-retaining Retractor, with hinge,
165mm, 6 1/2"

left side full blade, 170-783-165
right 3 prongs

right side full blade, left 3 prongs 170-784-165



WEITLANER BECKMANN

3x4 teeth, hinged arms, sharp

140mm, 5 1/2" 170-746-140

160mm, 6 1/4" 170-746-160

200mm, 8" 170-746-200

240mm, 9 1/2" 170-746-240

blunt

140mm, 5 1/2" 170-747-140

160mm, 6 1/4" 170-747-160

200mm, 8" 170-747-200

240mm, 9 1/2" 170-747-240



PLESTER

2 teeth, blunt, 110mm, 4 1/3"

solid blade on right 170-760-110

solid blade on left 170-761-110

22mm blade length

solid blade on right 170-762-110

solid blade on left 170-763-110



PLESTER

2x2 teeth, 130mm, 5 1/8"

blunt 170-762-130

sharp 170-763-130

**SCOVILLE HAVERFIELD**

Spreader, rigid arms, without valves

171mm spread 170-906-000

hinged arms, without valves

171mm spread 170-906-001



Hook, blunt

51mm 170-906-102

75mm 170-906-104



Hook, with crossbar

51mm 170-906-106

75mm 170-906-108



Blade, toothed

26 x 63mm 170-906-122

51 x 63mm 170-906-124

32 x 66mm 170-906-126

26 x 89mm 170-906-128



Blade, forked, blunt

38 x 41mm 170-906-144

48 x 66mm 170-906-145

FINESS MICRO ROUND-HANDLE INSTRUMENTS

Precision in Otologic Microsurgery

Designed for the highest demands in otologic and neurotologic procedures, the FINESS series combines an ergonomic round handle with refined tactile feedback for precise micro-rotation and control.

Integrated grooves enhance grip and orientation, while the polished working ends ensure atraumatic precision. Laser markings allow immediate identification during surgery. For surgeons who rely on absolute control and sensory precision.

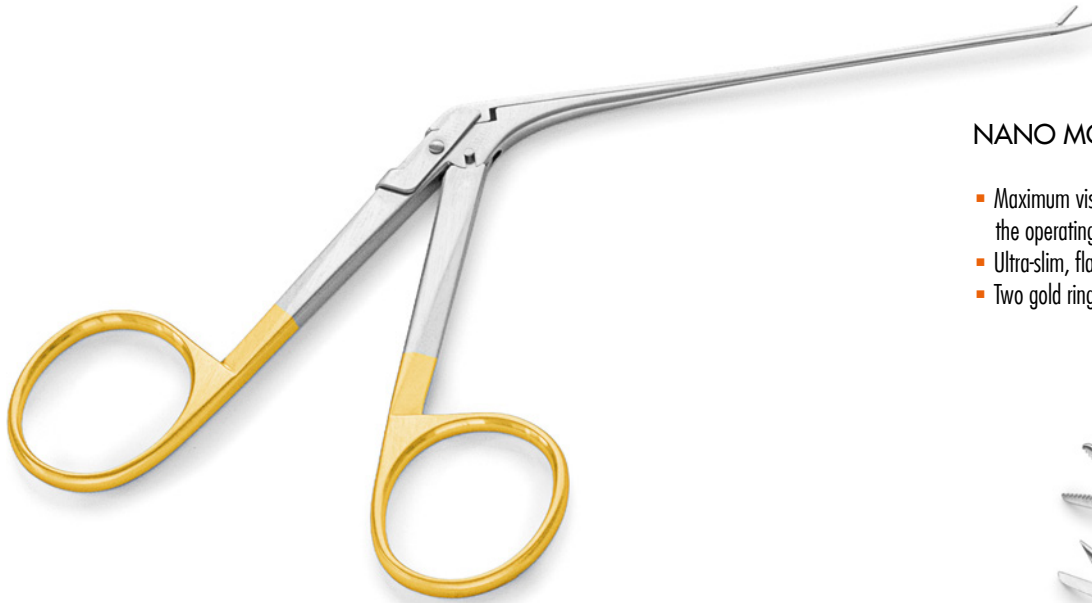

NANO MODELS

- Maximum visibility under the operating microscope
- Ultra-slim, flat jaws reduce visual obstruction
- Two gold rings for instant identification



FINESS



MICRO MODELS

- Precise, atraumatic control in delicate procedures
- Fine jaws and streamlined shaft for stable handling
- Single gold ring for instant identification

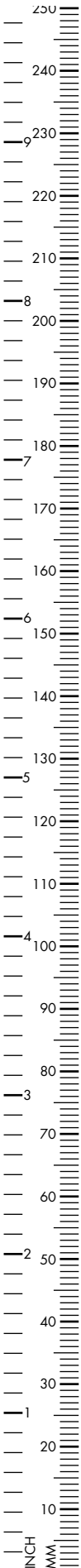

FINESS MICRO ROUND-HANDLE INSTRUMENTS



Nano Ear Forceps,
3.5mm long jaw, serrated

410-800-950



Nano Cup Forceps, 0.6mm

410-800-970



Nano Scissors

410-800-990



Micro Ear Forceps,
3.5mm long jaw, serrated

410-800-960



Micro Cup Forceps, 0.6mm

410-800-980

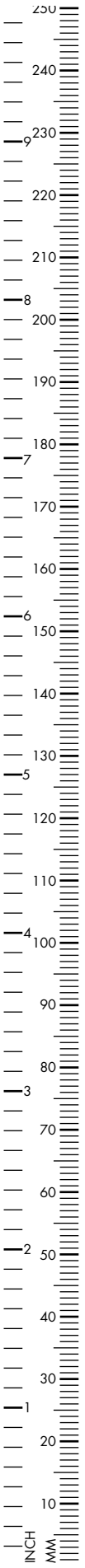

HARTMANN

Ear Forceps, 80mm working length, straight

1 x 8mm 410-210-085

125mm working length, straight

1 x 4.5mm 410-210-125

HARTMANN-WULLSTEIN

Ear Forceps, 80mm working length, straight

0.8 x 6.0mm 410-345-080

0.8 x 4.0mm 410-344-080

Ear Forceps, 80mm working length,

A Alligator, extra fine, 0.8 mm wide, straight

4.5mm jaw 410-335-800

B CERACUT®

4.5mm jaw 410-335-800CC

C smooth jaw

4.5mm jaw 410-335-700

D curved right

410-335-600

E curved left

410-335-500

F upcurved

410-335-400

G downcurved

410-335-300

H right curved

410-335-600

**HARTMANN**

Ear Forceps, 4.0mm long jaw,
serrated, self-closing

410-330-700

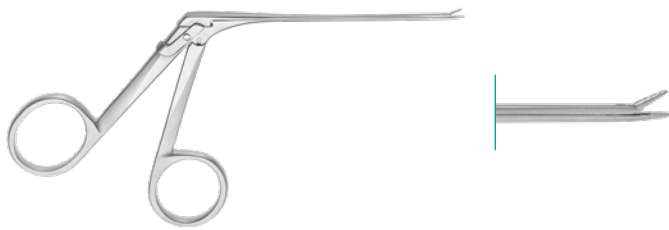

Ear Forceps, 80mm working length,
Alligator, extra fine, straight

0.8 x 3.0mm jaw 410-330-800

**DUCKBILL-WULLSTEIN**

Ear Forceps, extra delicate, smooth jaws

410-330-900

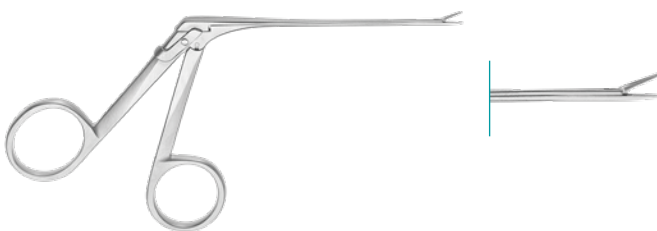
**FISCH**

Ear Forceps, very delicate, serrated,
1.5mm shaft, straight, 80mm working length

0.6 x 4.0mm 410-357-080

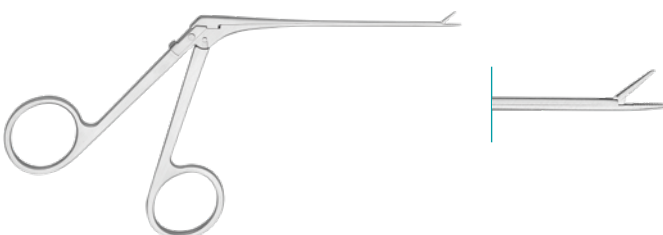
**FISCH**

Ear Forceps, very delicate, serrated,
1.5mm shaft, straight, 80mm working length

0.5 x 4.5mm 410-356-080

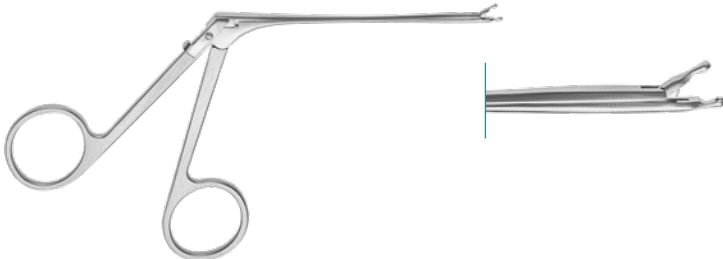
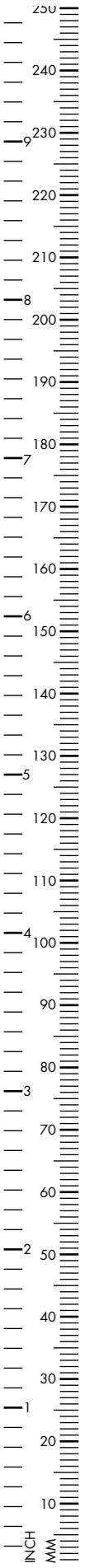

HARTMANN-WULLSTEIN

Ear Forceps, 80mm working length
straight, cup-shaped, round cup

1.0mm 410-346-080

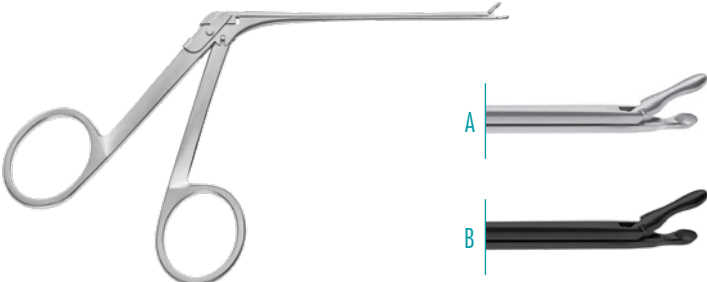

A



B



C



D



E



F

oval cups, 0.9mm wide,
fine model, 4.5mm jaw length

- | | |
|--------------------|---------------|
| A straight | 410-341-500 |
| B CERACUT® | 410-341-500CC |
| C left curved | 410-343-500 |
| D right curved | 410-344-500 |
| E upwards curved | 410-342-500 |
| F downwards curved | 410-347-500 |



Micro Cupped Forceps, 0.5 x 1.0 mm,
extra fine, oval

straight 410-330-004



A

B

Micro Cupped Forceps, 0.8 x 1.3 mm,
fine, oval

- | | |
|--------------------|-------------|
| A curved downwards | 410-330-002 |
| B curved upwards | 410-330-003 |

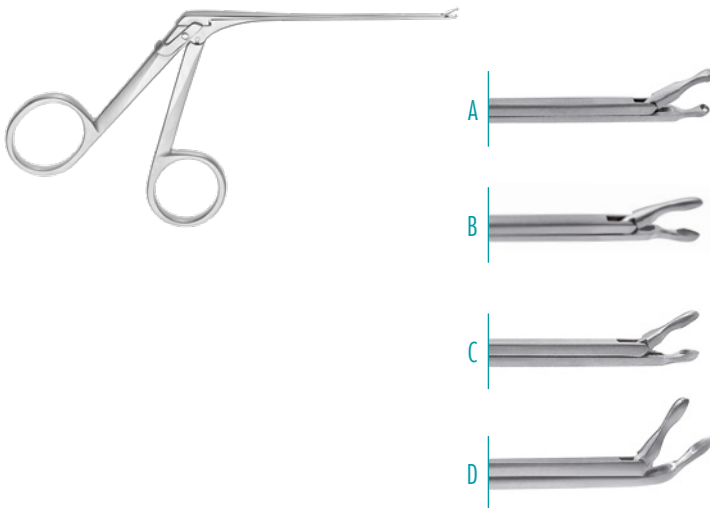

oval cups, 0.6mm wide,
4.5mm jaw

A straight	410-341-800
B right curved	410-344-800
C left curved	410-343-800
D 35° upwards	410-342-800



Micro Spoon Forceps, oval,
superfine, 0.5 x 1.0mm, 1.3 mm shaft

A straight	410-341-900
B upwards	410-342-900

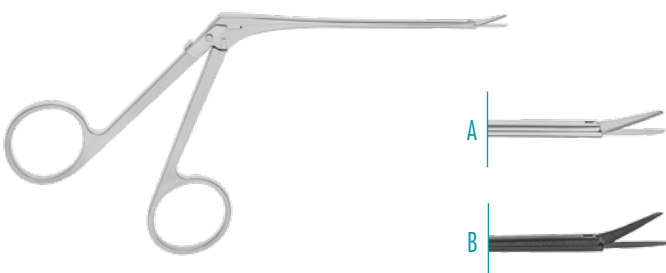

BELLUCCI

Micro Ear Scissors, 8mm cutting blade

A stainless steel	410-350-200
B CeraCut®	410-352-080CC



BELLUCCI

Micro Ear Scissors, 4mm blade

curved upwards	410-351-700
----------------	-------------

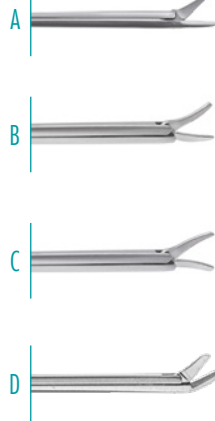
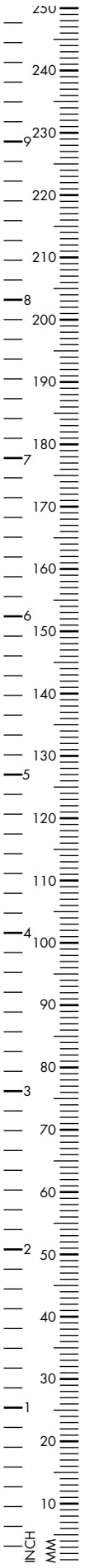

Middle model, 5.0mm blade length,
87mm working length

A straight	410-350-500
B left curved	410-352-500
C right curved	410-353-500
D 35° upcurved	410-351-500

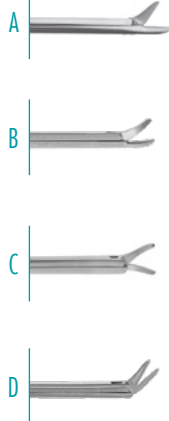

HOUSE BELLUCCI

Ear Scissors, fine model, 4.5mm blade

A straight	410-350-700
B left curved	410-352-700
C right curved	410-353-700
D curved up	410-351-700

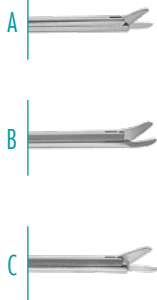

HOUSE BELLUCCI

Ear Scissors, extra fine

A straight	410-350-100
B left curved	410-352-100
C right curved	410-353-100



HOUSE BELLUCCI

Ear Scissors, extra fine, serrated blade,
3.5mm blade length

straight	410-351-800
----------	-------------



HOUSE BELLUCCI

Ear Scissors, superfine, 2.0mm blade length

straight	410-351-900
----------	-------------



Crurotomy Scissors,
80mm working length

A opening to left	410-250-001
-------------------	-------------

B opening to right	410-250-002
--------------------	-------------

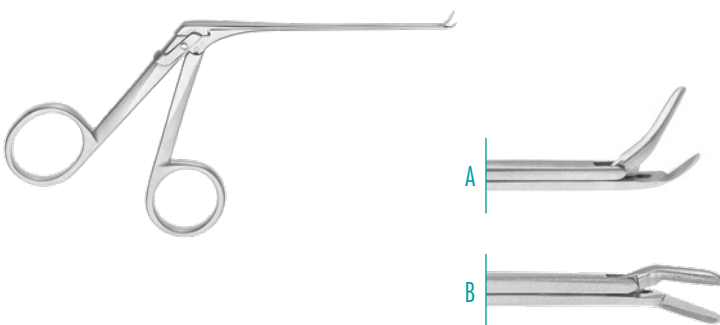

HOUGH

Nipper Forceps, angled, fine model

A 45° left	410-365-080
------------	-------------

B 45° right	410-366-080
-------------	-------------

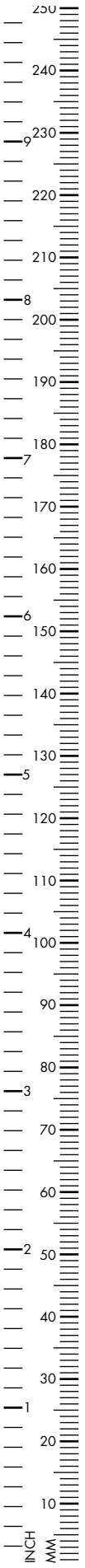

DIETER

Malleus Nipper, 80mm working length

A upwards cutting	410-300-100
B downwards cutting	410-301-100

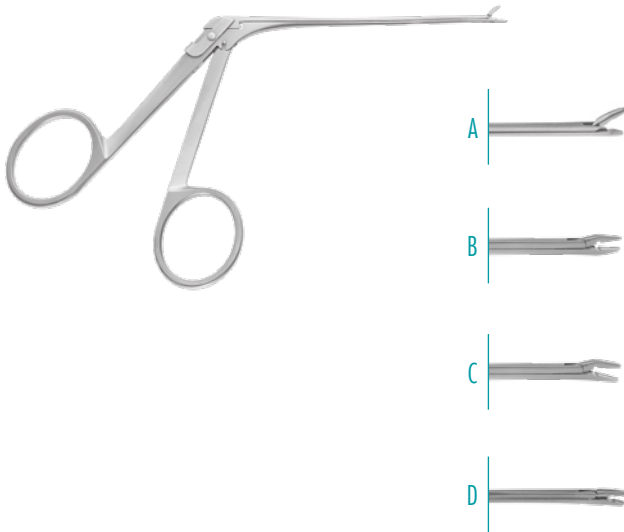

MC GEE

Malleus Crimper, fine model

A straight	410-359-200
B bent left	410-359-100
C bent right	410-359-300

HOUSE-MC GEE

Malleus Crimper

D superfine model	410-359-500
-------------------	-------------



MCGEE

Malleus Crimper, large model,
80mm working length

410-360-500



GREVEN

fine model

410-361-080

**VENT**

Tube Forceps, fine model

410-340-080

**KOS**

fine model

410-350-132

Micro Grasping Forceps, straight, jaw
with cross grooves, 1.4 x 4.0mm

straight

410-368-080

**SOFFERMANN**Needle Holder with ratchet, with sliding shaft,
serrated jaws, 4.5mm jaw

100mm working length 410-208-100

Aural forceps, tubular shaft, shaft 1.5mm, jaws 2.3mm
80mm working length



1 x 2 teeth
straight 410-342-100



serrated jaws
straight 410-342-110



Cup-Shaped Forceps, straight

Ø 1.0mm	410-343-110
Ø 1.5mm	410-343-210
Ø 2.0mm	410-343-310
Ø 2.5mm	410-343-410
Ø 1.5 x 0.8mm	410-343-510



Cup-Shaped Forceps,
angled up

Ø 1.0mm	410-343-120
Ø 1.5mm	410-343-220
Ø 2.0mm	410-343-320
Ø 2.5mm	410-343-420
Ø 1.5 x 0.8mm	410-343-520



Cup-Shaped Forceps,
curved right

Ø 1.0mm	410-343-130
Ø 1.5mm	410-343-230
Ø 2.0mm	410-343-330
Ø 2.5mm	410-343-430
Ø 1.5 x 0.8mm	410-343-530



Cup-Shaped Forceps,
curved left

Ø 1.0mm	410-343-140
Ø 1.5mm	410-343-240
Ø 2.0mm	410-343-340
Ø 2.5mm	410-343-440
Ø 1.5 x 0.8mm	410-343-540



straight
410-351-010



straight horizontal
410-351-020



angled up
410-351-030



angled up horizontal
410-351-040



curved right
410-351-050



curved left
410-351-060

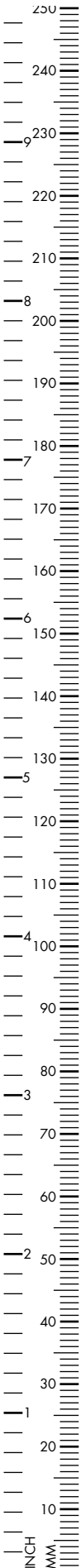

Aural Forceps, 0.9mm tubular shaft, 1.8mm jaws
80mm working length



straight

410-352-010



straight horizontal

410-352-020



angled up

410-352-030



angled up horizontal

410-352-040



curved right

410-352-050



curved left

410-352-060



1 x 2 teeth

straight

410-343-100



serrated

straight

410-341-100

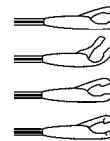

cup-shaped

straight

410-340-100

curved up

410-340-120

curved right

410-340-130

curved left

410-340-140

Micro Ear Instruments with tubular shaft
and LuerLock cleaning channel
80mm working length



HARTMANN
straight

0.8 x 3.5mm 410-330-000

HARTMANN
straight

1.0 x 5.0mm 410-335-00

HARTMANN
straight

1.5 x 6.0mm 410-321-000

WULLSTEIN
straight, oval cup spoon

0.9 x 1.0mm 410-341-000

WULLSTEIN
straight, oval cup spoon

0.8 x 1.3mm 410-345-000

WULLSTEIN
straight, round cup spoon

Ø 1.0 mm 410-346-000

BELLUCCI
Micro scissors, straight

5.0mm 410-350-000

BELLUCCI
Micro scissors, curved left

5.0mm 410-352-000

BELLUCCI
Micro scissors, curved right

5.0mm 410-353-000

MCGEE
Malleus Crimper

3.5mm jaw length 410-359-000

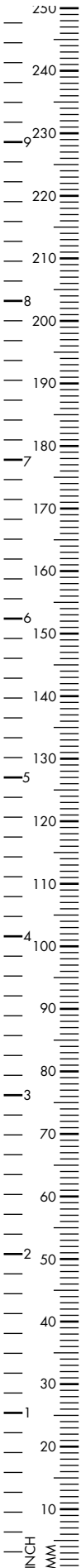

FINESS MICRO EAR INSTRUMENTS



165mm working length

WULLSTEIN

Micro Hook, 90° angled

0.2mm	410-800-102
0.4mm	410-800-104
0.5mm	410-800-105
0.6mm	410-800-106
0.8mm	410-800-108
1.0mm	410-800-110
1.2mm	410-800-112
1.5mm	410-800-115
2.0mm	410-800-120
2.5mm	410-800-125
3.0mm	410-800-130
4.0mm	410-800-140

WULLSTEIN

Micro Hook, 45° angled

0.2mm	410-800-202
0.4mm	410-800-204
0.6mm	410-800-206
0.8mm	410-800-208
1.0mm	410-800-210
1.2mm	410-800-212
1.5mm	410-800-215
2.0mm	410-800-220
2.5mm	410-800-225

ROSEN

Round Knife, 45° angled

1.0mm	410-800-310
1.2mm	410-800-312
1.5mm	410-800-315
1.8mm	410-800-318
2.0mm	410-800-320
2.3mm	410-800-323
2.5mm	410-800-325
3.0mm	410-800-330

ROSEN

Round Knife, 90° angled

0.6mm	410-800-406
1.0mm	410-800-410
1.5mm	410-800-415
2.0mm	410-800-420
2.3mm	410-800-423
2.5mm	410-800-425

ROSEN

Round Knife, 0° angled

1.0mm	410-800-510
1.5mm	410-800-515
2.0mm	410-800-520
2.3mm	410-800-523
2.5mm	410-800-525
3.0mm	410-800-530

F FINESS MICRO EAR INSTRUMENTS

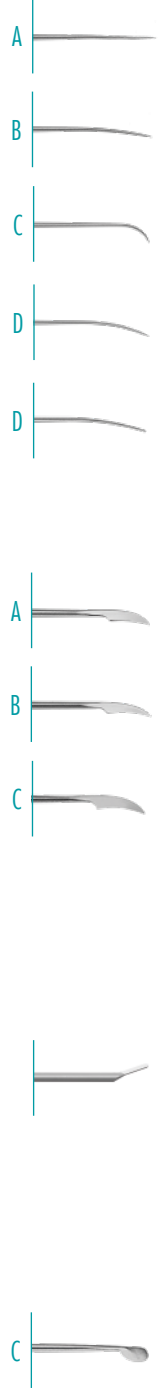
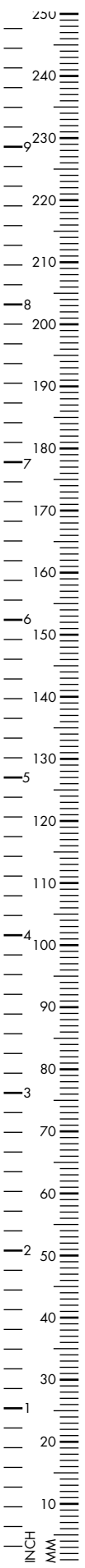

WULLSTEIN
Micro Needle

A	straight, sharp	410-800-600
B	very slightly curved, sharp	410-800-610
C	strongly curved, sharp	410-800-620
D	slightly curved, sharp	410-800-630
D	very slightly curved, blunt	410-800-640

WULLSTEIN
Sickle Knife

A	slightly curved	410-800-710
B	slightly curved, delicate	410-800-720
C	strongly curved	410-800-730

Incodostapedial Joint Knife

20°, 2.2mm	410-800-722
------------	-------------

PLESTER
Flap Knife, vertical, oval

3.5 x 2.5mm	410-800-732
-------------	-------------

FINESS MICRO EAR INSTRUMENTS

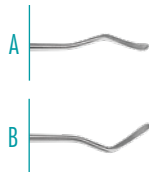

AUSTIN

Dissector

A right curved 410-800-801

B left curved 410-800-802

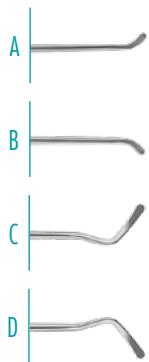

FISCH

Dissector, single curved

A right 410-800-811

B left 410-800-812

double curved

C right 410-800-821

D left 410-800-822

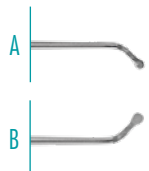

PREYER

Dissector, sinus tympani, circular marking

A right curved 410-800-831

B left curved 410-800-832



FISCH

Footplate Perforator

0.3mm 410-800-843

0.4mm 410-800-844

0.5mm 410-800-845

0.6mm 410-800-846

F FINESS MICRO EAR INSTRUMENTS

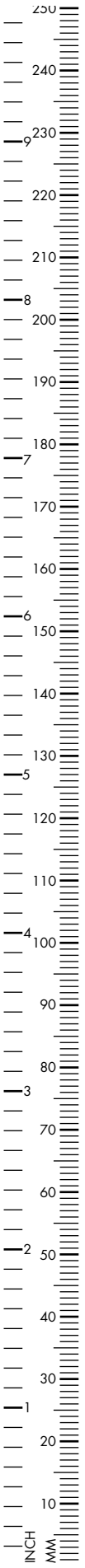

PLESTER

Footplate Hook

0.2mm	410-800-852
0.4mm	410-800-854
0.6mm	410-800-856

Hand burr, diamond, fine

0.7mm	410-800-877
-------	-------------

MOD. TÜBINGEN

Measuring Instrument for Stapes
Prosthesis with ball tip

4.5mm	410-138-045
-------	-------------

THOMASSIN

Dissector, single curved, double ended

180mm, 7"	410-800-901
-----------	-------------

THOMASSIN

Dissector, double curved, double ended

190mm, 7"	410-800-902
-----------	-------------

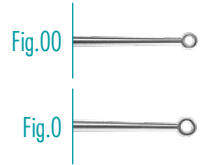

BUCK

Ohrkürette

Fig. 00	410-103-000
Fig. 0	410-103-001



PLESTER

Flap Knife, round cutting, 160mm, 6¹/₄"

2.4 x 3.0mm	410-124-160
2.4 x 3.5mm	410-092-001

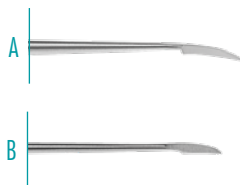

PLESTER

Sickle Knife, 160mm, 6¹/₄"

A slightly curved	410-101-160
B straight	410-100-160



THOBURN

Sickle Knife, curved

160mm, 6 ¹ / ₄ "	410-103-160
--	-------------



BEALES

Tendon Knife

170mm, 6 ² / ₃ "	410-109-170
--	-------------

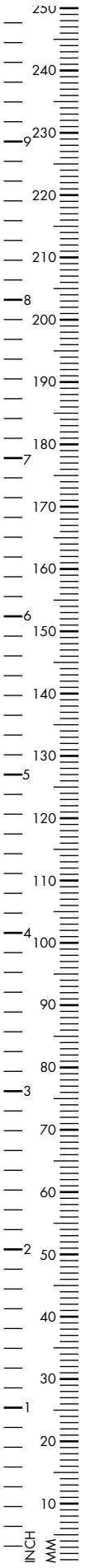

WULLSTEIN

Sickle Knife, delicate, slightly curved

410-105-160



FISCH

Tenotome, curved

410-107-160



KLEY

Knife

410-109-160



ROSEN

Knife and elevator, spear pointed blade

160mm, 6¹/₄" 410-093-160

**SEIFFERT**Salivial Duct Probe, \varnothing 0.9mm

180mm, 7"

410-045-180

**ROSEN**

Elevator, 15° angled tip, 12 x 1.5mm

160mm, 6¹/₄"

410-135-015

**DUCKBILL**

Elevator, 80mm working length

155mm, 6¹/₈"

410-000-155

**BEALES**

Elevator, 1.5mm

410-130-182

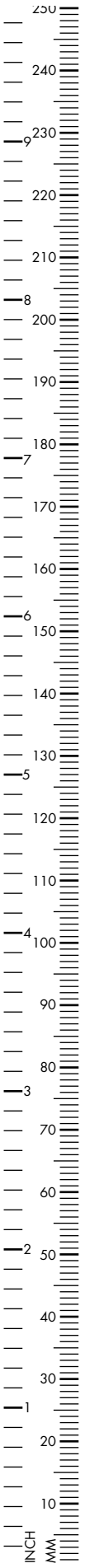

HUGHES
Stapes Mobilizer
165mm, 6¹/₂" 410-216-165



HUGHES
Elevator, 0.6mm
165mm, 6¹/₂" 410-216-166



HOUSE
Stapes Elevator, slightly angled, 12mm,
1mm wide
160mm, 6¹/₄" 410-135-050

**ROSEN**

Elevator, round edge, slightly curved, 1.8mm

160mm, 6^{1/4}" 410-135-051Graft holder and elevator,
2 x 6mm160mm, 6^{1/4}" 410-135-048Eardrum Mirror, 160mm, 6^{1/4}"

Ø 3mm 410-141-163

Ø 5mm 410-141-165



Seeker, 45°, angled

155mm, 6^{1/8}" 410-150-155

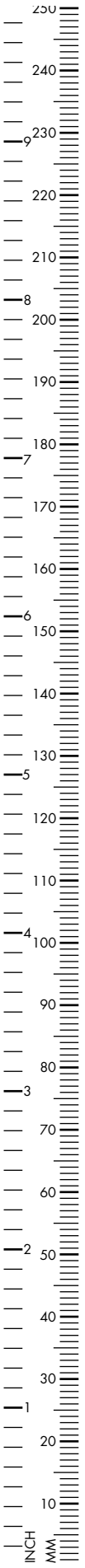

SHEA

Curette for tympanoplasty, sharp, oval cup, upwards cutting, 1.5 x 2.5mm, 160mm, 6¹/₄"

straight	410-046-160
knee bent	410-047-160

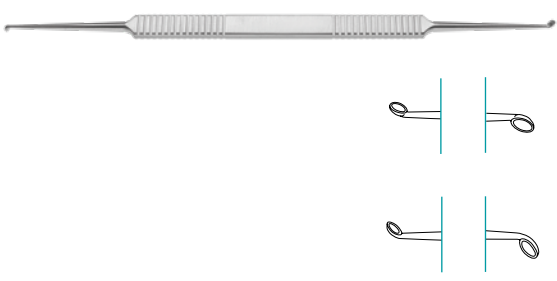

HOUSE

Curette for stapedectomy, sharp, double-ended, oval cup, 150mm, 6"

1.5 x 1.2mm	
slightly curved	410-044-001
strongly curved	410-044-003
1.5 x 1.8mm	
slightly curved	410-044-002
strongly curved	410-044-004



HOUSE

Curette, 20° curved, 150mm, 6"

2.2 x 3.8mm /	410-044-006
2.4 x 4.8mm	
2.6 x 3.5mm /	410-044-007
2.8 x 3.2mm	
0.6 x 0.8mm /	410-044-010
0.8mm x 1.0mm	

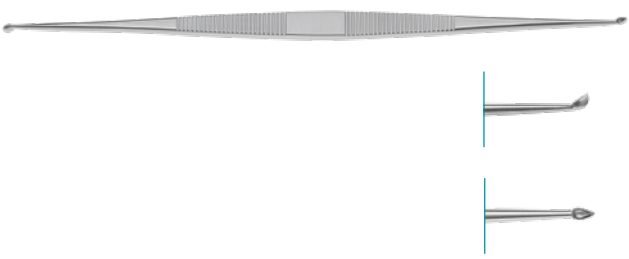

HOUSE

Curette, slightly bent, pointed, 1.6 x 3.0mm / 2.0 x 3.2mm

170mm, 6 ² / ₃ "	410-044-008
--	-------------

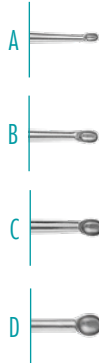

HOUSE

Double Spoon, slightly curved,
170mm, 6²/₃"

A Fig.0	410-044-100
1.0 x 1.6mm / 1.2 x 2.0mm	
B Fig.1	410-044-101
1.5 x 2.5mm / 1.8 x 2.8mm	
C Fig.2	410-044-102
2.2 x 3.0mm / 2.5 x 3.2mm	
D Fig.3	410-044-103
2.6 x 3.2mm / 2.8 x 3.5mm	



HOUSE-STAPES

Curette, double-ended,
2.2 x 3.0mm / 2.5 x 3.2mm
30° angled

170mm, 6 ² / ₃ "	410-044-150
--	-------------



Micro Needle (perforator), 160mm, 6¹/₄"

A straight	
sharp	410-110-155
blunt	410-110-160
B slightly curved, long curvature	
	410-112-155
C slightly curved	
	410-111-155
D acute curved	
	410-114-155
E acute long curvature	
	410-116-155

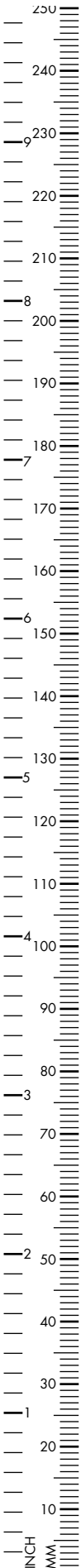

ROSEN

Round Cutting Knife, straight, 160mm, 6¹/₄"

1.0mm	410-128-010
1.5mm	410-128-015
2.0mm	410-128-020
2.5mm	410-128-025
3.0mm	410-128-030



ROSEN

Round Cutting Knife, slender, 160mm, 6¹/₄"

45° angled

Ø 1.0mm	410-118-010
Ø 1.2mm	410-118-012
Ø 1.5mm	410-118-015
Ø 1.8mm	410-118-018
Ø 2.0mm	410-118-020
Ø 2.3mm	410-118-023
Ø 2.6mm	410-118-026
Ø 2.8mm	410-118-028
Ø 3.0mm	410-118-030
Ø 3.5mm	410-118-035
Ø 4.0mm	410-118-040

90° angled

Ø 1.0mm	410-119-010
Ø 1.5mm	410-119-015
Ø 2.0mm	410-119-020
Ø 2.3mm	410-119-023
Ø 2.5mm	410-119-025

**PLESTER**

Wire Guide and Applicator, flat end, V-notch

160mm, 6^{1/4}" 410-216-160**PLESTER**

Aural scraper, 60° angled, 2.0mm

160mm, 6^{1/4}" 410-120-020**HEERMANN**

Hook, reverse cutting, 0.6mm

160mm, 6^{1/4}" 410-216-006

Micro Hook, slightly angled up tip

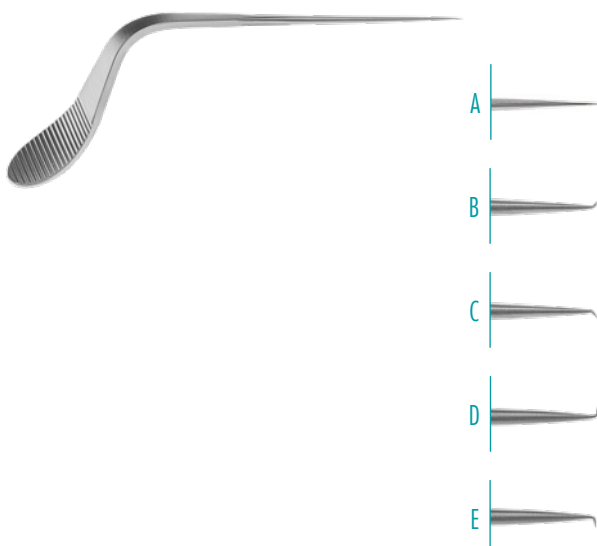
160mm, 6^{1/4}" 410-216-007**ZOELLNER**

Needle, 0.5mm tip

A straight 410-165-001

B 45° curved up 410-165-002

C 45° curved down 410-165-003

D 90° curved up 410-165-004

E 90° curved down 410-165-005

1.0 mm tip

B 45° curved up 410-165-006

C 45° curved down 410-165-007

D 90° curved up 410-165-008

E 90° curved down 410-165-009

WULLSTEIN

Micro Hook,
160mm, 6¹/₄"



25° angled

0.3mm	410-115-003
0.6mm	410-115-006
1.0mm	410-115-010

45° angled

0.2mm	410-117-002
0.3mm	410-117-003
0.4mm	410-117-004
0.6mm	410-117-006
0.8mm	410-117-008
1.0mm	410-117-010
1.2mm	410-117-012
1.5mm	410-117-015
2.0mm	410-117-020
2.5mm	410-117-025

90° angled

0.2mm	410-210-002
0.3mm	410-210-003
0.4mm	410-210-004
0.6mm	410-210-006
0.8mm	410-210-008
1.0mm	410-210-010
1.2mm	410-210-012
1.5mm	410-210-015
2.0mm	410-210-020
2.5mm	410-210-025

WULLSTEIN-COLOR

Micro Hook,
160mm, 6¹/₄"



90°

1.0mm, 5 orange rings	410-117-161
0.2mm, 1 orange ring	410-117-162
0.4mm, 2 orange rings	410-117-164
0.6mm, 3 orange rings	410-117-166
0.8mm, 4 orange rings	410-117-168

45°

1.0mm, 5 cyan rings	410-115-161
0.2mm, 1 cyan ring	410-115-162
0.4mm, 2 cyan rings	410-115-164
0.6mm, 3 cyan rings	410-115-166
0.8mm, 4 cyan rings	410-115-168

BARBARA

Needles and Hooks

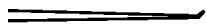
160mm 6¹/₄"

25° angled upwards

0.3mm	410-210-303
0.6mm	410-210-306
1.0mm	410-210-310



25° angled downwards

0.3mm	410-210-203
0.6mm	410-210-206
1.0mm	410-210-210



45° angled upwards

0.3mm	410-217-003
0.6mm	410-217-006
1.0mm	410-217-010

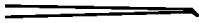

45° angled downwards

0.3mm	410-217-103
0.6mm	410-217-106
1.0mm	410-217-110



90° angled upwards

0.3mm	410-216-003
0.6mm	410-216-005
1.0mm	410-216-010



90° angled downwards

0.3mm	410-116-103
0.6mm	410-116-105
1.0mm	410-116-110



Knee bent, straight

410-113-155

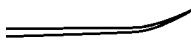

Knee bent, curved

410-115-153



retrograde angled upwards

0.5mm	410-116-205
1.0mm	410-116-210

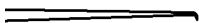

retrograde angled downwards

0.5mm	410-116-305
1.0mm	410-116-310

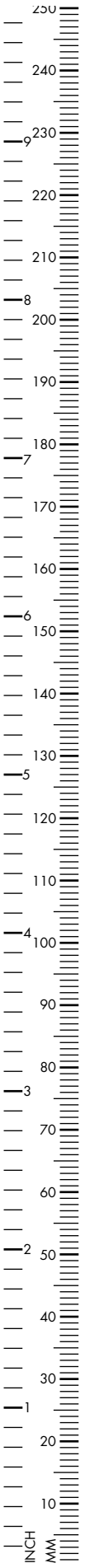

AUSTIN

Attic Dissector, 90° angled, blunt,
3mm

165mm, 6¹/₂" 410-157-090

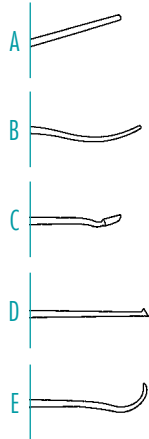

AUSTIN

165mm, 6¹/₂"

- | | |
|--------------------|-------------|
| A Elevator, 1.0mm | 410-157-001 |
| B Raspatory, 1.0mm | 410-157-002 |
| B Raspatory, 1.2mm | 410-157-003 |
| C Spoon | 410-157-004 |
| D Hook, 0.6mm | 410-157-005 |
| E Raspatory, 1.8mm | 410-157-006 |



FISCH

Excavator, narrow, 160mm, 6¹/₄"

- | | |
|----------------------|-------------|
| double curved, left | 410-135-060 |
| double curved, right | 410-135-061 |
| single curved, left | 410-135-062 |
| single curved, right | 410-135-063 |



FISCH

Dissector, 160mm, 6¹/₄"

- | | |
|---------------------|-------------|
| single curved right | 410-017-001 |
| single curved, left | 410-017-002 |



THOMASSIN

Dissector, double ended, double curved

180mm, 7" 410-162-180

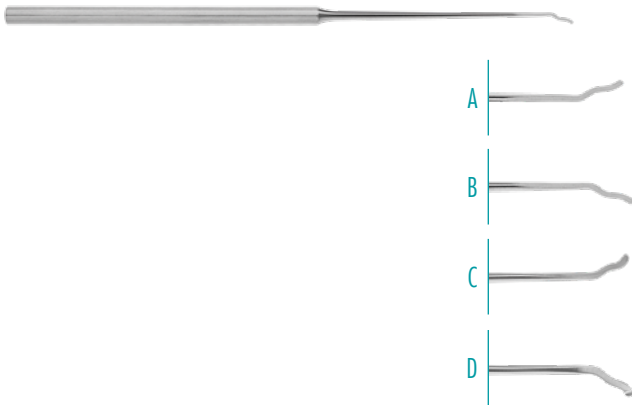

WHIRLY-BIRD

Knife, 15mm, 6",
0.75 x 5.0mm

A right curved	410-110-150
B left curved	410-110-151
1.0 x 5.0mm	
C right curved	410-110-152
D left curved	410-110-153

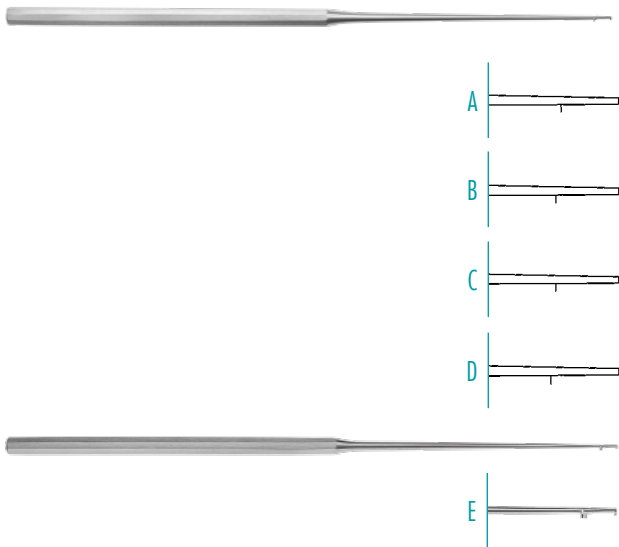

AUSTIN

Measuring Probe, 160mm, 6¹/₄"

A Mark 3.5mm	410-142-135
B Mark 4.5mm	410-142-140
C Mark 4.5mm	410-142-145
D Mark 5.0mm	410-142-150
E with 3 lengths	
Mark	410-142-166
3.5 / 4.0 / 4.5mm	



FISCH

Caliper, 165mm, 6¹/₂"

0.4mm	410-137-004
0.6mm	410-137-006
0.8mm	410-137-008



FISCH

Perforator, 165mm, 6¹/₂"

0.3mm	410-137-013
0.4mm	410-137-014
0.5mm	410-137-015
0.6mm	410-137-016
0.7mm	410-137-017
0.8mm	410-137-018

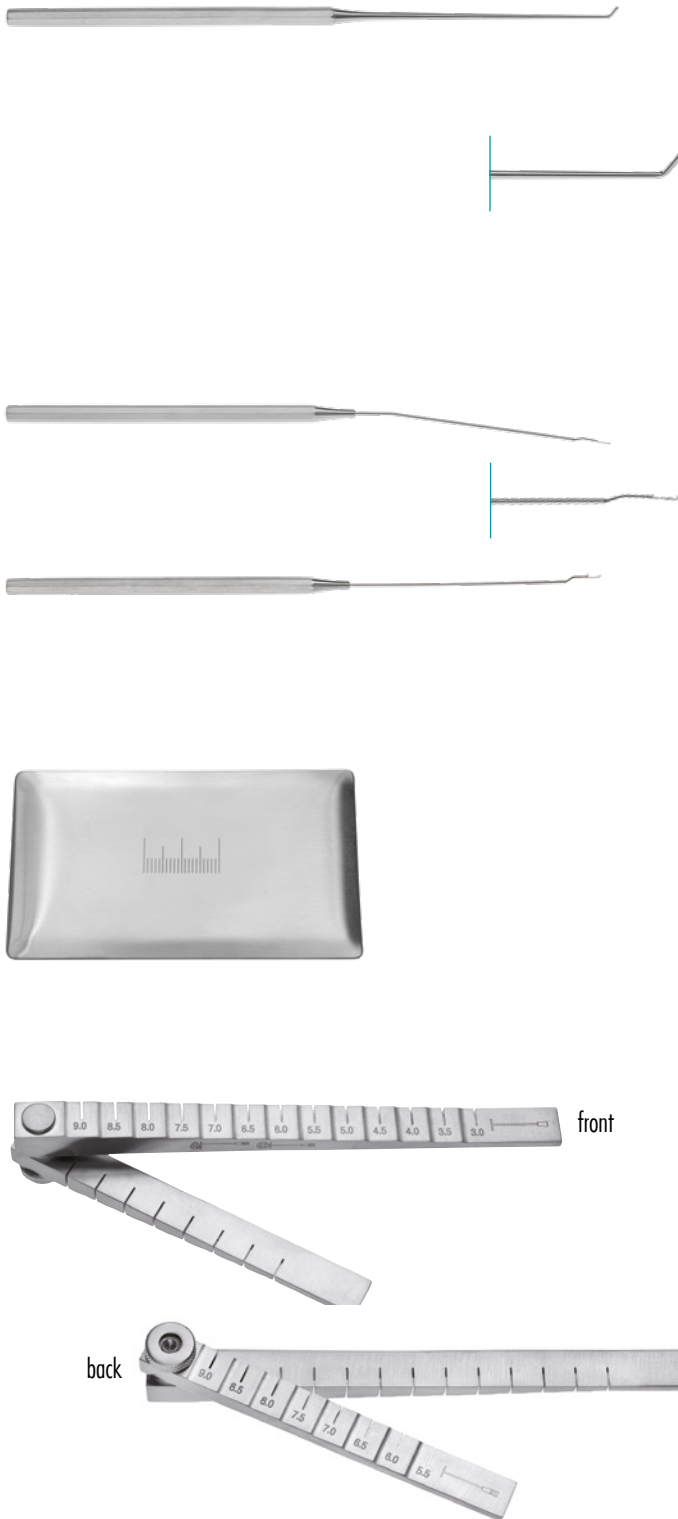
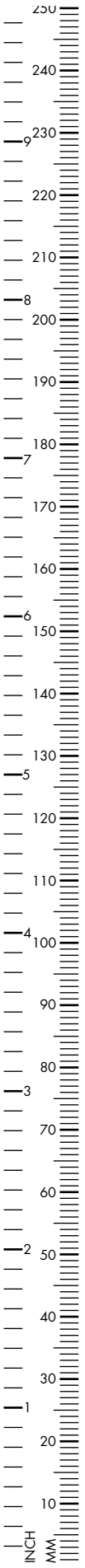

HOUSE

Reference Instrument, octagonal handle, 160mm, 6¹/₄"

2.5mm	410-138-250
2.7mm	410-138-275
3.0mm	410-138-300
3.2mm	410-138-325
3.5mm	410-138-350
3.7mm	410-138-375
4.0mm	410-138-400
4.2mm	410-138-425
4.5mm	410-138-450
4.7mm	410-138-475
5.0mm	410-138-500

FISCH

Reference instrument, 3.5/ 4.0/ 4.5mm, 160mm, 6¹/₄"

curved	410-142-161
straight	410-142-160

Preparation tray with mm scale, stainless steel

92 x 54mm	410-143-000
-----------	-------------

Universal Titanium Prosthesis Sizer, measuring from 2.5 until 9.0mm

410-155-800

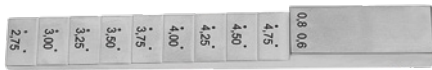

Piston Cutting Jig for Teflon Prosthesis

410-144-000



Measuring and cutting block for PTFE stapes prostheses, 0.4mm and 0.6mm

410-155-000



Tube Insertion Instrument

100mm, 4" working length 410-223-010



Micro measuring probe for stapedectomy and tympanoplasty, 180mm, 7"

0-7mm 410-142-180

0-8mm, detachable 410-141-180

**HEERMANN**

Handle for holding special chisels and gouges
410-144-017 - 410-144-030

410-144-100

**HEERMANN**

Gouge

0.7mm 410-144-007

1.0mm 410-144-010

1.5mm 410-144-015

1.7mm 410-144-017

3.0mm 410-144-030

**HEERMANN**

Gouge

0.7mm 410-144-107

1.0mm 410-144-110

1.5mm 410-144-115

3.0mm 410-144-130

**HEERMANN**

Mallet, hollow handle, narrow head

195mm, 7³/₄" 410-144-200

**SCHUKNECHT**

Bending Device for Stapes Prosthesis

410-145-000

**SHEA**

Vein Press

16mm	410-153-016
30mm	410-153-030

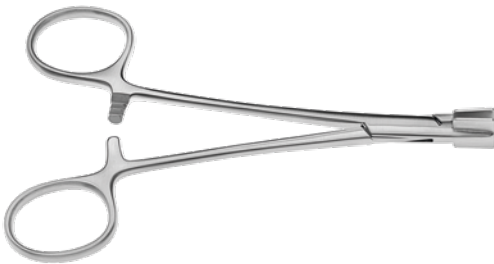

Vein Graft, press forceps, smooth square jaws
130mm, 5^{1/8}"

12x15mm	410-154-130
---------	-------------

160mm, 6^{1/4}"

11x14mm	410-154-160
---------	-------------

180mm, 7"

11x14mm	410-154-180
---------	-------------

22x30mm	410-156-180
---------	-------------

30x30mm	410-155-180
---------	-------------

**WÜRZBURG**

Rock leg holder, completely detachable

410-905-000



Micro Container with lid and bottom perforation, with textile «Longterm» filter

200 x 140 x 45mm	600-402-140
280 x 195 x 45mm	600-402-195
265 x 255 x 45mm	600-402-255
380 x 260 x 50mm	600-402-260

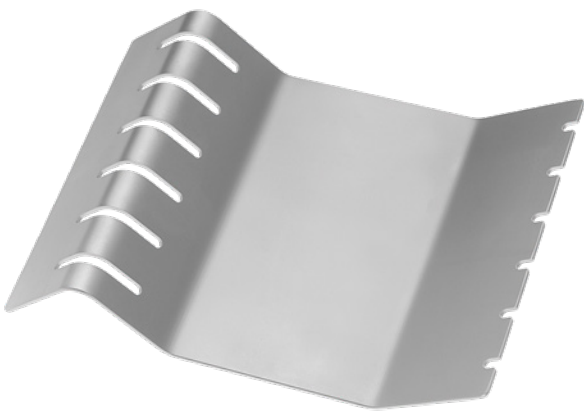

Instrument Rack for 6 ear forceps

600-150-005

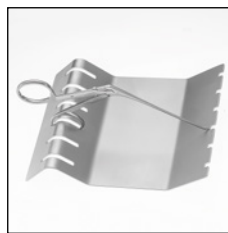

RHINOLOGY



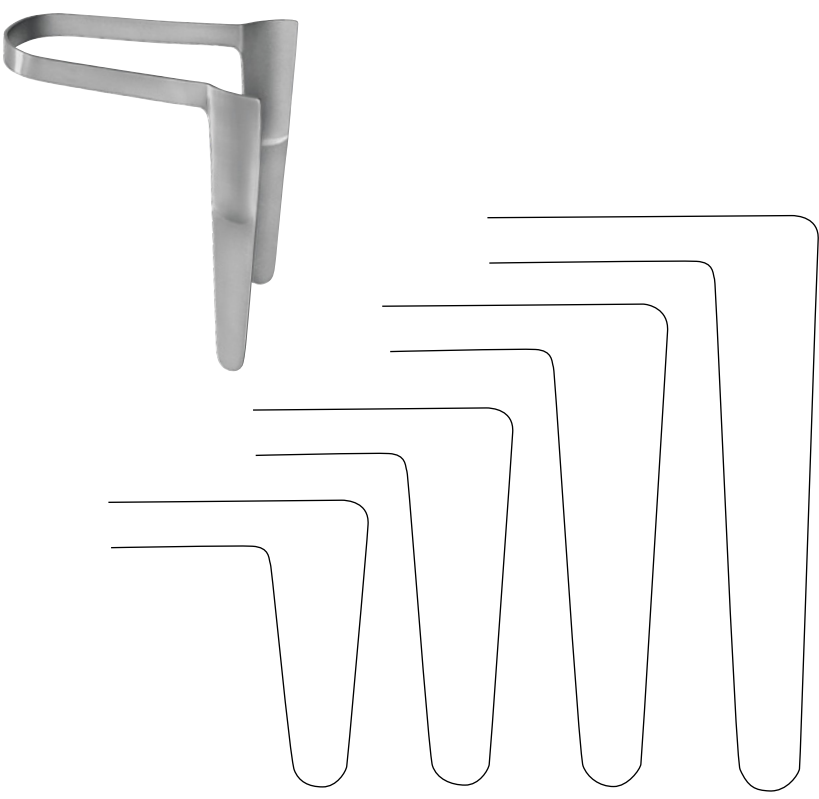
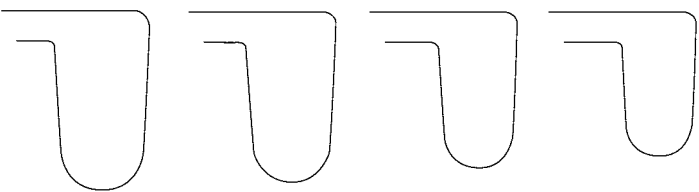
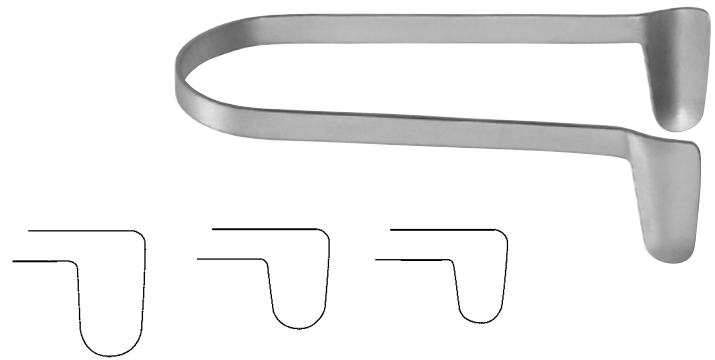
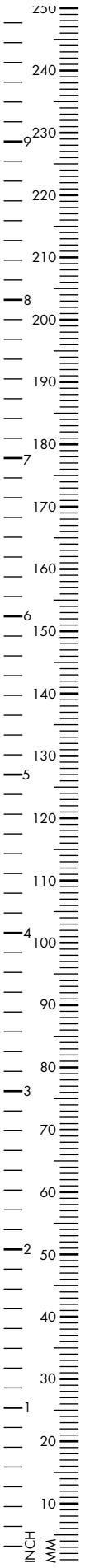

THUDICHUM (MARK HOVELL)

Nasal Specula, 70mm, 2 1/2"

8.5 x 6.0mm	420-050-001
9.0 x 7.0mm	420-050-002
12.5 x 8.0mm	420-050-003
15.0 x 8.5mm	420-050-004
18.0 x 10.0mm	420-050-006
19.5 x 10.5mm	420-050-007

insulated

8.5 x 6.0mm	420-050-101
9.0 x 7.0mm	420-050-102
12.5 x 8.0mm	420-050-103
15.0 x 8.5mm	420-050-104
18.0 x 10.0mm	420-050-106
19.5 x 10.5mm	420-050-107

ST. CLAIR THOMPSON

Nasal Specula, 73mm, 2 1/2"

38mm	420-052-001
50mm	420-052-002
65mm	420-052-003
75mm	420-052-004

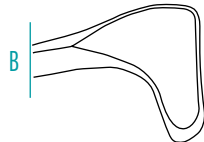
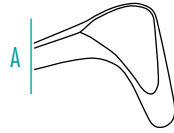
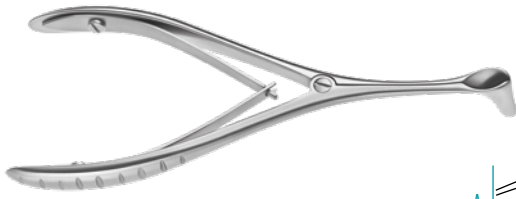

TIECK-HALLE

Nasal Specula, 135mm, 5¹/₃"

A Infants, 17.5mm 420-140-135

B Children, 21.0mm 420-142-135



BECKMANN

Nasal Specula, Infants, curved sidewards,
17.5mm

130mm, 5¹/₈" 420-147-140

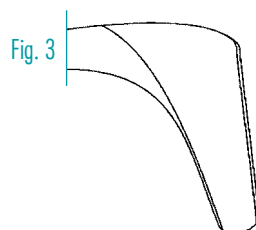
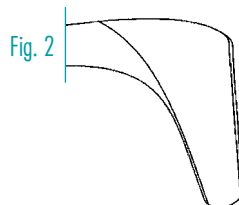
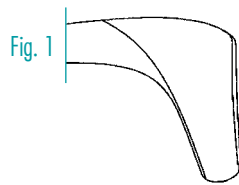

BECKMANN

Nasal Specula, 150mm, 6"

Fig. 1 22mm 420-148-150

Fig. 2 25mm 420-146-152

Fig. 3 28mm 420-146-153

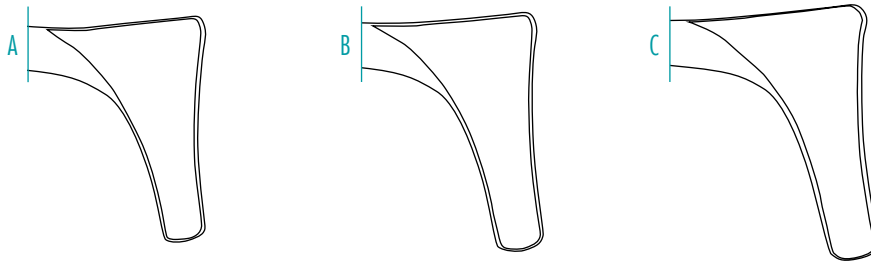
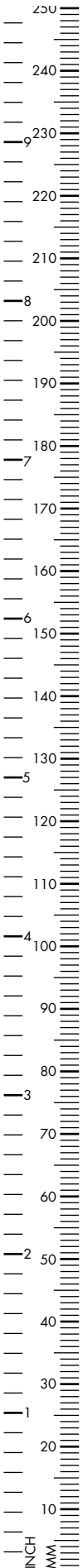

HARTMANN

Nasal Specula, 160mm, 6¹/₄"

A Fig. 1	420-119-001
29 x 7mm	
B Fig. 2	420-119-002
33 x 7mm	
C Fig. 3	420-119-003
35 x 7mm	

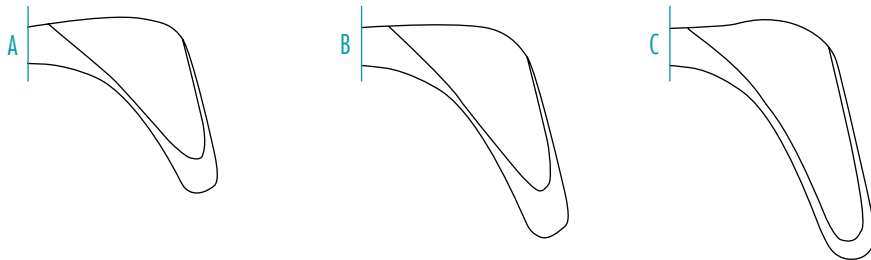

HARTMANN-HALLE

Nasal Specula, 155mm, 6¹/₈"

A Fig. 1, 27mm	420-121-150
B Fig. 2, 31mm	420-122-150
C Fig. 3, 37mm	420-123-150

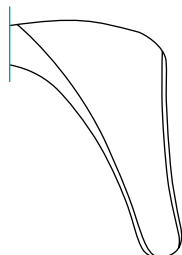

HARTMANN-HALLE

Nasal Speculum, tapered blade, aseptic joint, 155mm, 6¹/₈"

Fig. 2, 33mm	420-124-033
--------------	-------------

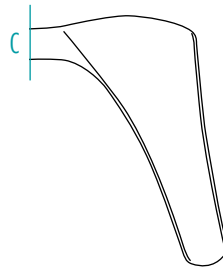
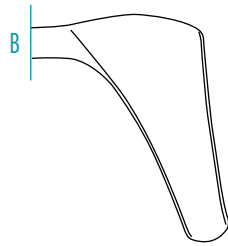
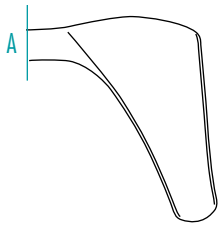

MOD. VIENNA

Nasal Specula, 130mm, 5¹/₈"

A Fig. 1 420-100-001
28 x 7mm

B Fig. 2 420-100-002
30 x 7mm

C Fig. 3 420-100-003
32 x 7mm

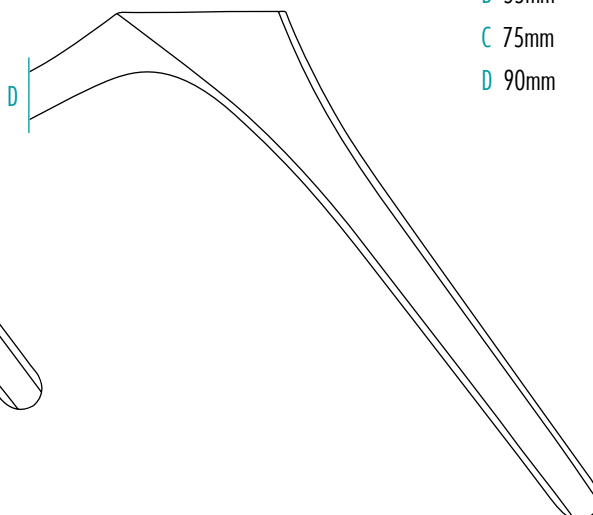
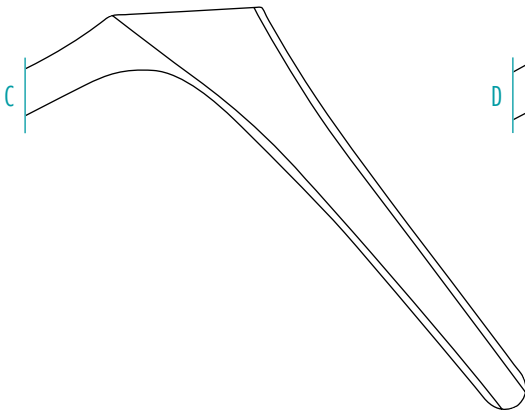
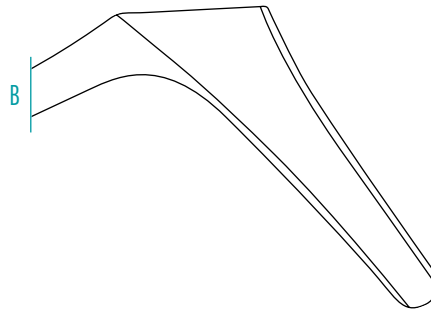
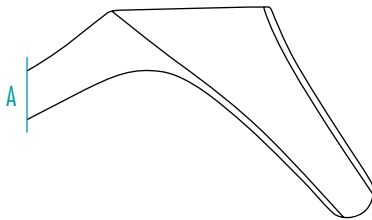

KILLIAN-STRUYCKEN

Nasal Speculum, aseptic joint, 140mm, 5¹/₂"

A 40mm 420-147-040

B 55mm 420-147-055

C 75mm 420-147-075

D 90mm 420-147-090



with locking screw

A 40mm 420-146-040

B 55mm 420-146-055

C 75mm 420-146-075

D 90mm 420-146-090

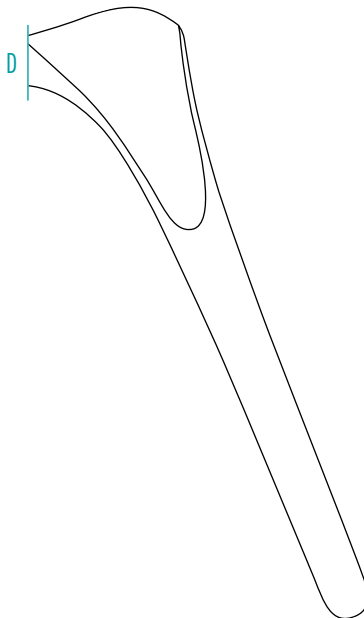
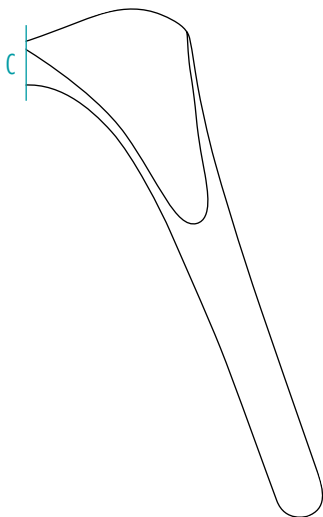
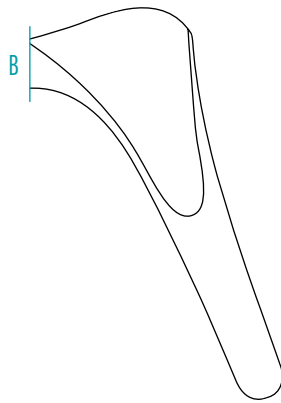
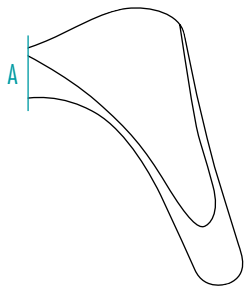

KILLIAN

Nasal Speculum, aseptic joint, 140mm, 5 1/2"

A 40mm	420-143-040
B 55mm	420-143-055
C 75mm	420-143-075
D 90mm	420-143-090

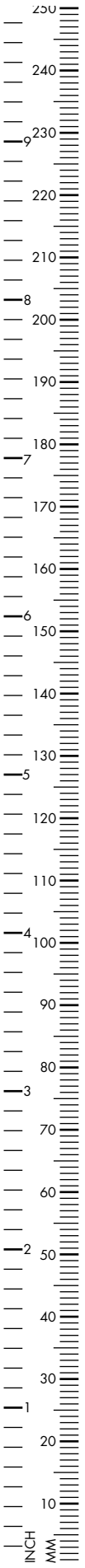

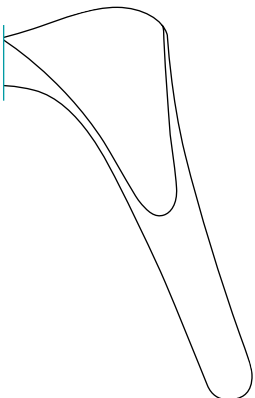
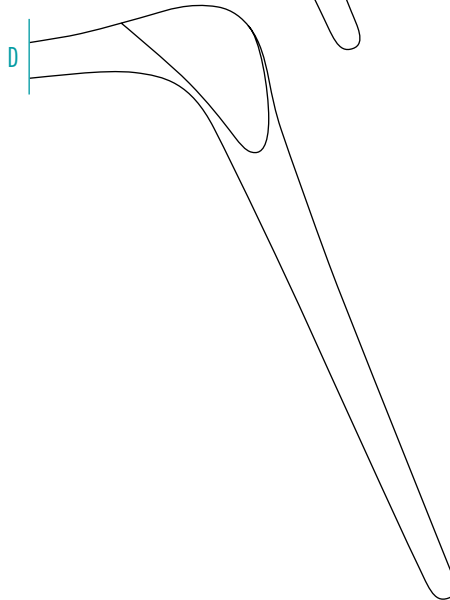
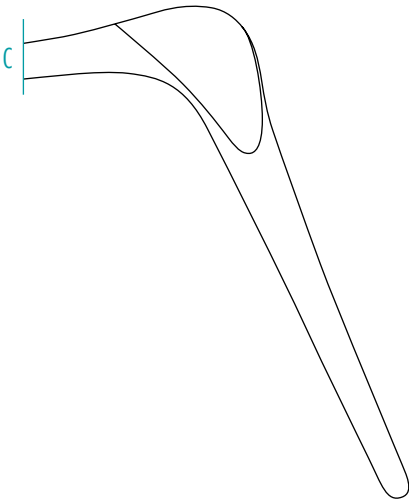
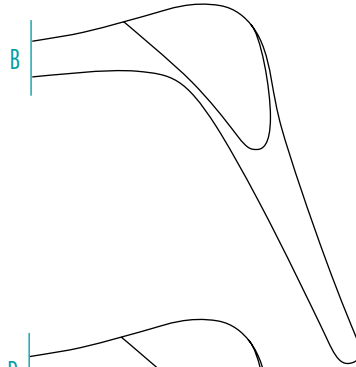
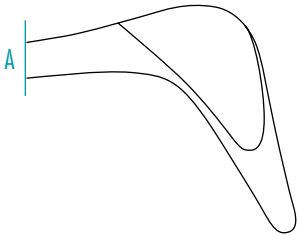

COTTLE

Nasal Speculum, aseptic joint, 130mm, 5¹/₈"

A	35mm	420-132-035
B	50mm	420-132-055
C	75mm	420-132-075
D	90mm	420-132-090



KILLIAN-WALTER

Nasal Speculum, thin blades, aseptic joint, 140mm, 5¹/₂"

	55mm	420-138-055
--	------	-------------

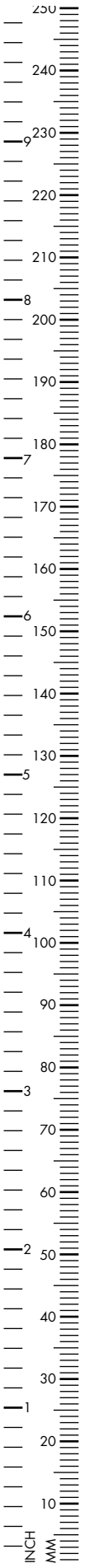

COTTLE

Nasal Speculum, aseptic joint, 130mm, 5¹/₈"

A	35mm	420-135-035
B	55mm	420-135-055
C	65mm	420-135-065
D	75mm	420-135-075
E	90mm	420-135-090

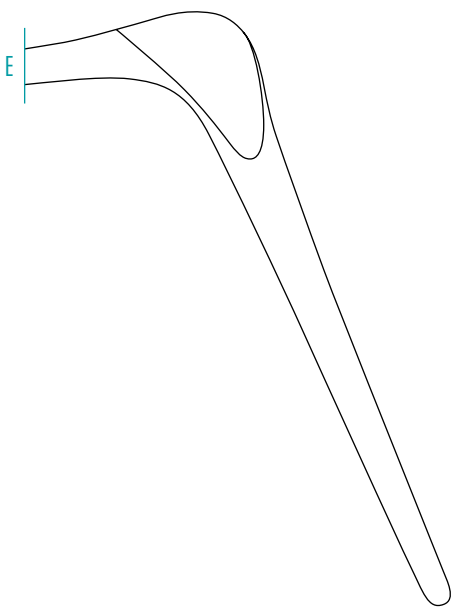
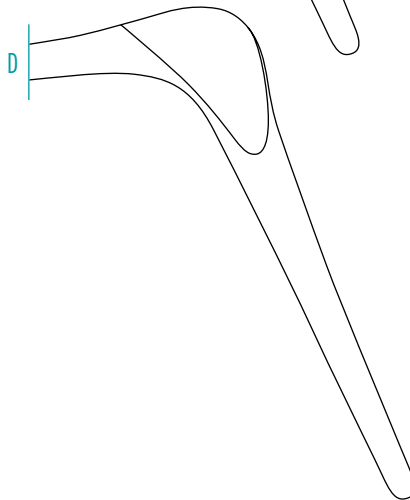
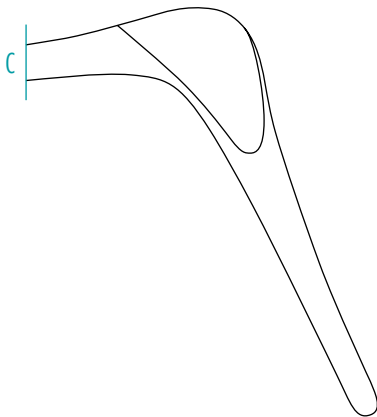
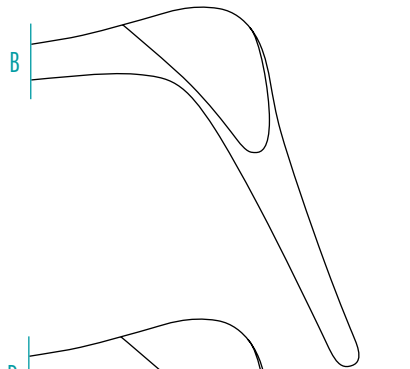
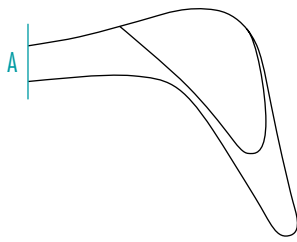

**COTTLE**

Nasal Speculum, aseptic joint,
with detachable cold light carrier,
140mm, 5¹/₂"

A	40mm	420-743-040
B	55mm	420-743-055
C	75mm	420-743-075
D	90mm	420-743-090

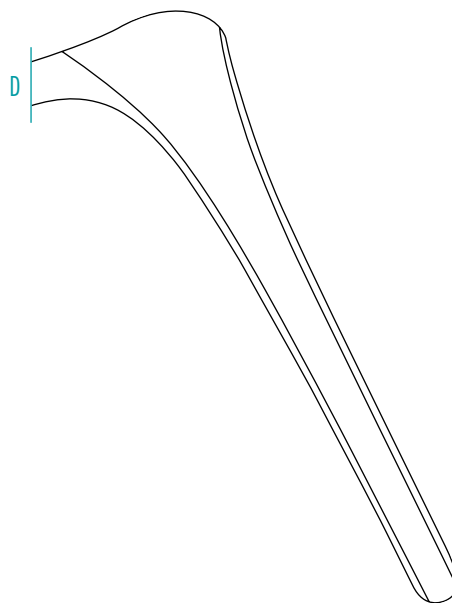
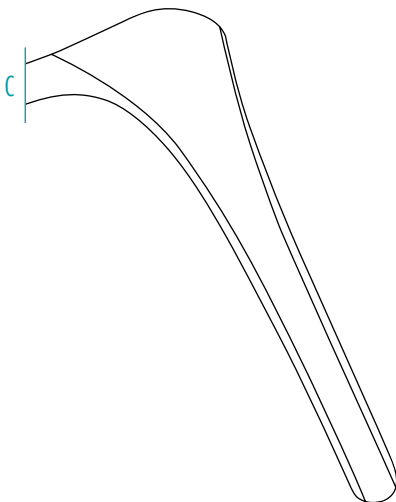
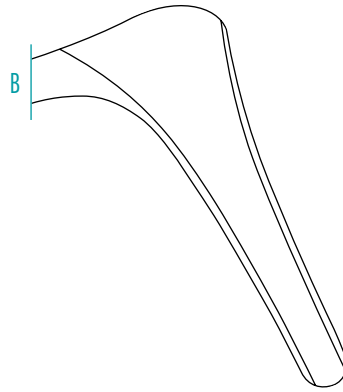
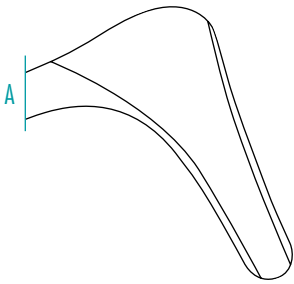

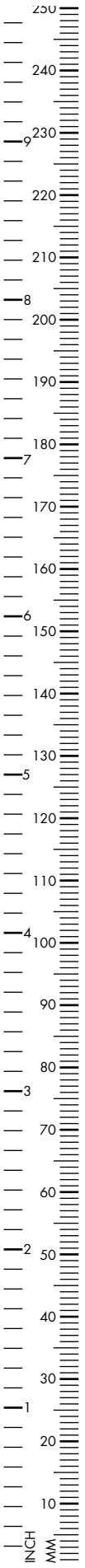

A



B



C



D



E

Flexible Arm, complete with holding rod,
without rotating clamp

A 251-010-000

Rotating clamp for flexible tension arm
attachable to operating table

B 251-010-100

Nasal Specula Clamp for flexible arm

C 251-010-400

AUFRICHT

Nasal Specula for flexible arm

D 251-010-500

AUFRICHT

Nasal Hook, 2 prongs, for flexible arm

E 251-010-600

**COTTLE MASING**

Nasal Specula for flexible arm

35mm	420-140-035
50mm	420-140-050
75mm	420-140-075
90mm	420-140-090
100mm	420-140-100

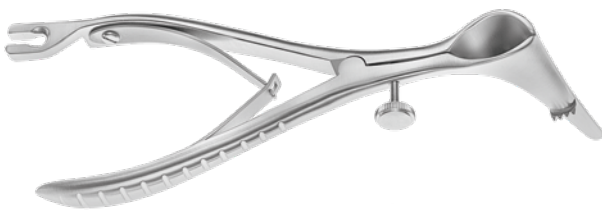
Sinus Specula for flexible arm,
with teeth

left: 55mm right: 35mm	420-150-001
left: 35mm right: 55mm	420-150-002
left: 65mm right: 45mm	420-150-003
left: 45mm right: 65mm	420-150-004
left: 75mm right: 35mm	420-150-005
left: 35mm right: 75mm	420-150-006
left: 75mm right: 40mm	420-150-007
left: 40mm right: 75mm	420-150-008

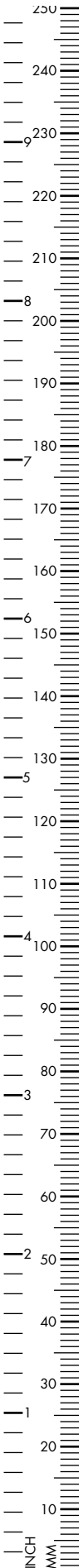

KILLIAN

Nasal Probe, slightly curved, Ø 1.5mm

165mm, 6¹/₂" 420-150-165



Nasal Probe, knee angled, Ø 1.4mm

160mm, 6¹/₄" 420-150-160



FARRELL

Applicator, triangulated serrated end, Ø 1.2mm

165mm, 6¹/₂" 160-426-165



Nasal Applicator, triangulated serrated end, Ø 1.1mm

160mm, 6¹/₄" 160-426-160



FARRELL (LATHBURY-UEBE)

Cotton Applicator, threaded, Ø 1.2mm

165mm, 6¹/₂" 160-420-165



Cotton Applicator, rough spiral end,
180mm, 7"

Ø 1.5mm 160-412-180

Ø 1.8mm 160-411-180



SIEBENMANN

Nasal Plugger

180mm, 7" 420-150-180



JANSEN

Nasal Dressing Forceps, bayonet shaped,
serrated jaws

160mm, 6^{1/4}" 410-395-160



GRUENWALD

Nasal Dressing Forceps, bayonet shaped,
serrated jaws

200mm, 8" 410-389-190



TROELTSCH (WILDE)

Nasal Dressing Forceps, knee bent

170mm, 6^{2/3}" 420-375-165

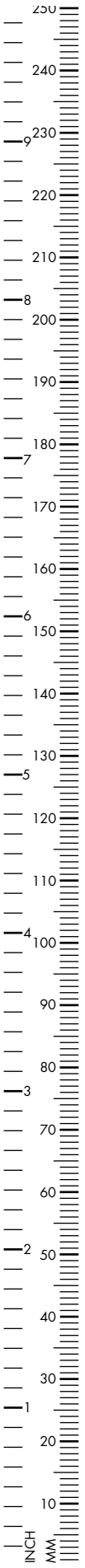

Suction Tube, 165mm, 6¹/₂"

Ø 3.0mm	410-165-030
Ø 3.5mm	410-165-035
Ø 4.5mm	410-165-045

Suction Tube, 195mm, 7²/₃"

Ø 4.5mm	410-195-045
---------	-------------



Nasal Suction Tube, Ø5mm, Ø6.5mm tip

180mm, 7"	165-064-160
-----------	-------------

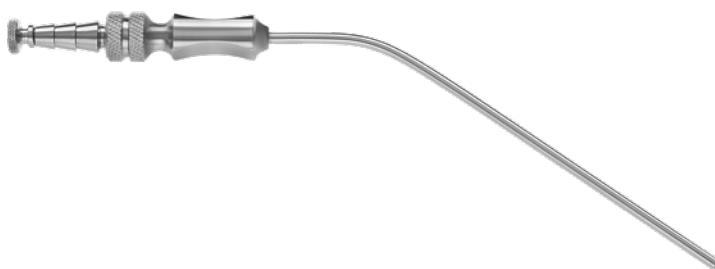

FRAZIER

Suction Tube, 190mm, 7¹/₂"

Ø 1.6mm, 5 Charr.	165-523-005
Ø 2.0mm, 6 Charr.	165-523-006
Ø 2.3mm, 7 Charr.	165-523-007
Ø 2.5mm, 8 Charr.	165-523-008
Ø 3.0mm, 9 Charr.	165-523-009
Ø 3.3mm, 10 Charr.	165-523-010
Ø 3.6mm, 11 Charr.	165-523-011
Ø 4.0mm, 12 Charr.	165-523-012
Ø 5.0mm, 15 Charr.	165-523-015

**HARTMANN**

Nasal Dressing Forceps

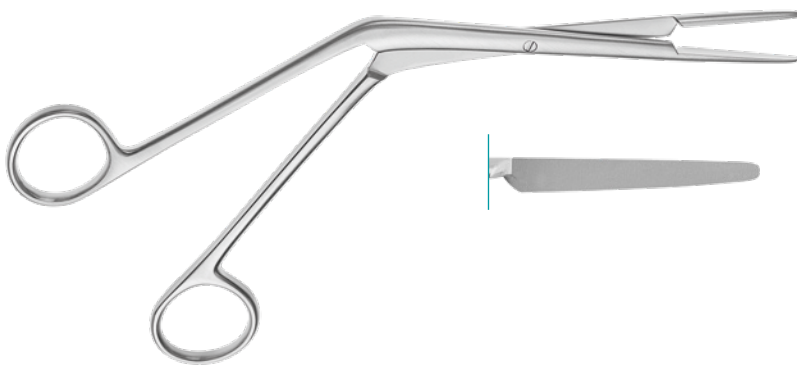
215mm, 8^{1/2}" 420-211-200175mm, 6^{7/8}" 420-211-160**LUBET-BARBON**

Polypus Forceps, smooth jaws

200mm, 8" 420-210-200

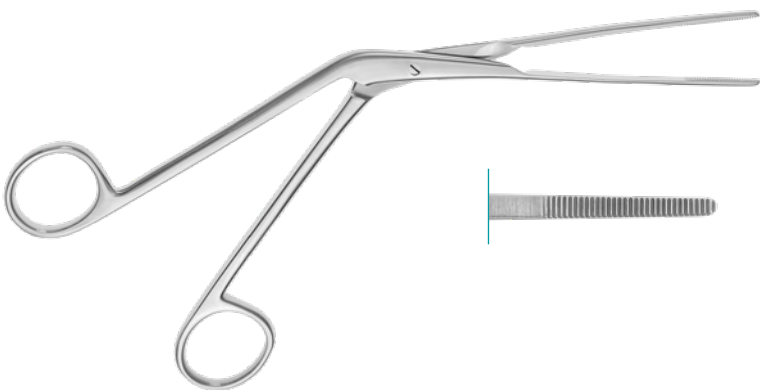
**WEST**

Nasal Dressing Forceps

200mm, 8" 420-411-200

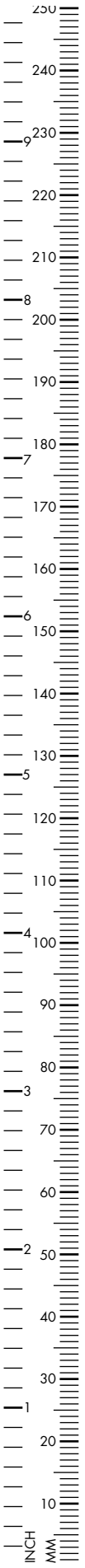

YANKAUER
Nasal Dressing Forceps

420-210-175



TILLEY
Nasal Dressing Forceps, serrated

130mm, 6¹/₄" 410-232-140

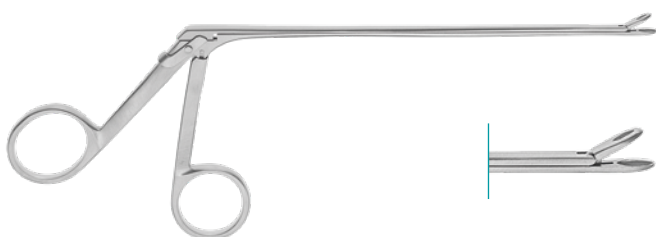

STRUEMPEL
Forceps, 2.5mm spoon

130mm, 6¹/₄" 410-338-234

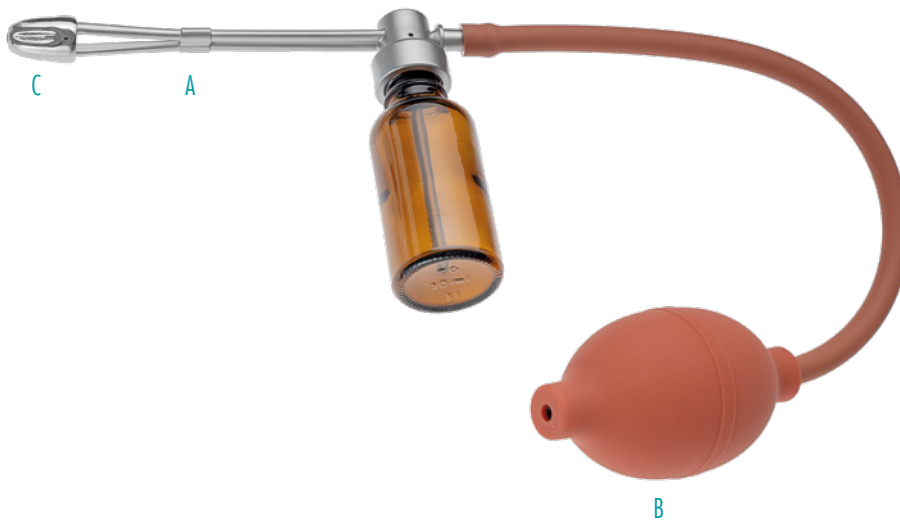

Universal Atomizer, complete set

410-228-000

A Liquid Atomizer only

410-228-050

B Rubber Bulb only

410-228-100

C Nose Guard only

410-228-010



GLATZEL

Nasal Mirror, 200 x 130mm

200 x 130mm

420-001-000

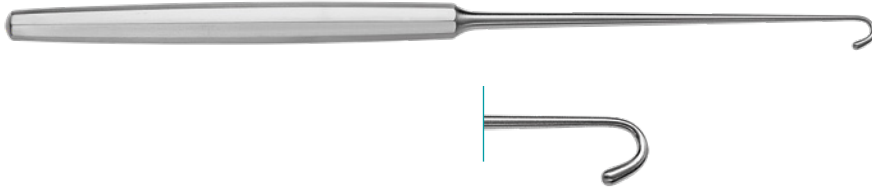
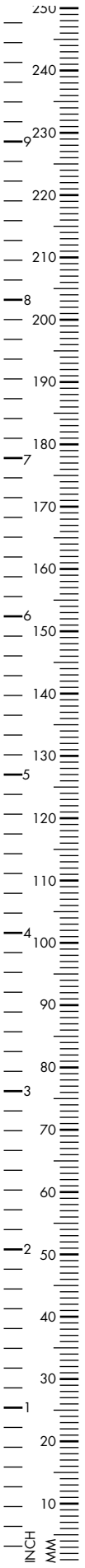

LANGE

Choana hook

230mm, 9"

420-413-230

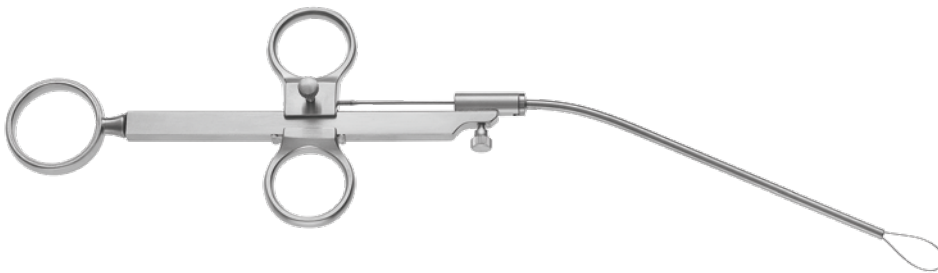

KRAUSE

Nasal Polypus Snare, knee bent

250mm, 9⁷/₈"

420-201-260

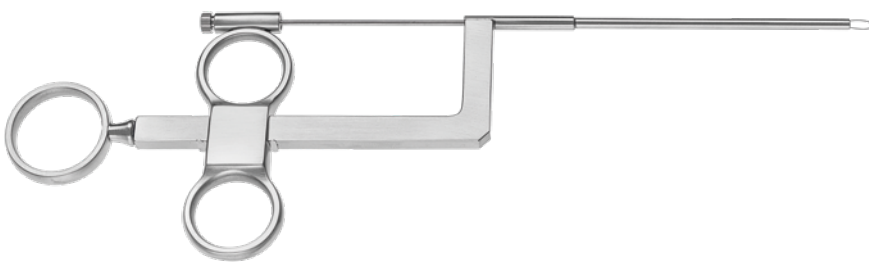

WILDE

Nasal Polypus Snare, bayonet shaped

250mm, 9⁷/₈"

410-270-250



Wire loops for nasal polyp snares,
package of 100pcs.

Ø 3.0mm 420-210-003



Snare Wire in coils, Ø 3.0mm,
1 coil of 10 meters

420-210-013



HEYMAN KNIGHT

Nasal Scissors, knee bent

180mm, 7" 120-283-180

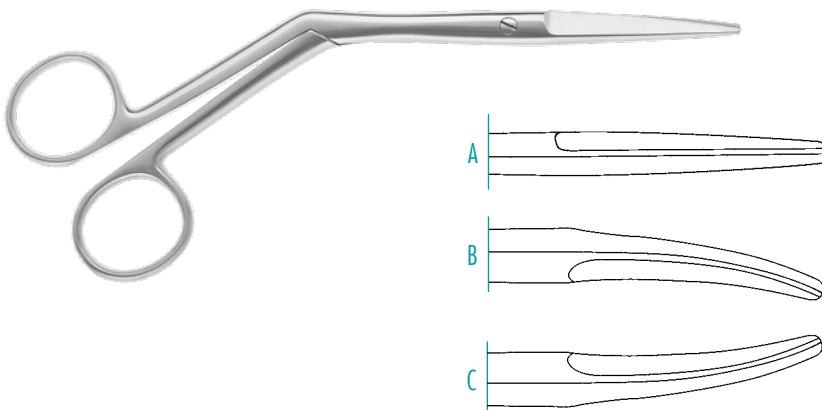

HEYMANN

Nasal Scissors, serrated upper blade,
190mm, 7^{1/2}"

A straight 120-284-180

B right curved 120-287-180

C left curved 120-285-180



HEYMANN

TC Nasal Scissors, straight, serrated

195mm, 7³/₄"

120-585-180



KIRSTEIN

Nasal Scissors, serrated

180mm, 7"

120-285-175



OLIVECROMA

Nasal Scissors, serrated

230mm, 9"

120-208-230

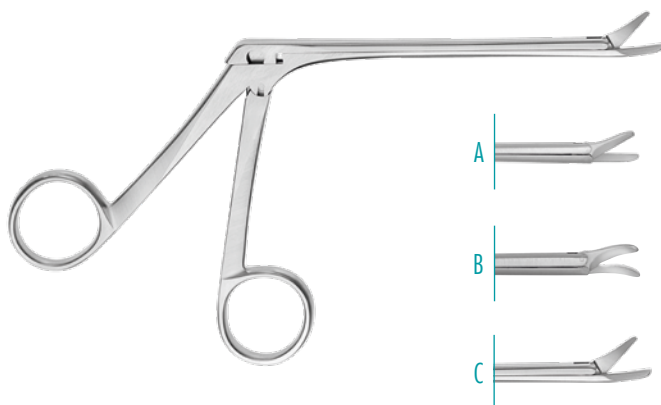

Nasal Scissors, serrated upper blade,
120mm, 4³/₄"

A straight 420-414-120

B right curved 420-415-120

C left curved 420-416-120

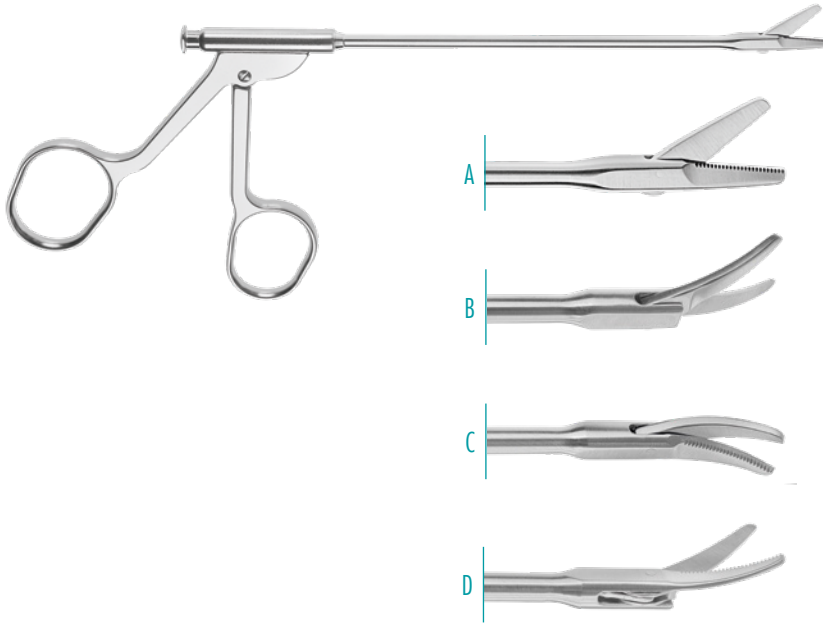

Nasal Scissors, Ø 3.5mm
130mm, 5¹/₈"

A straight	252-023-130
B left curved	252-024-130
C right curved	252-025-130
D curved up	252-026-130

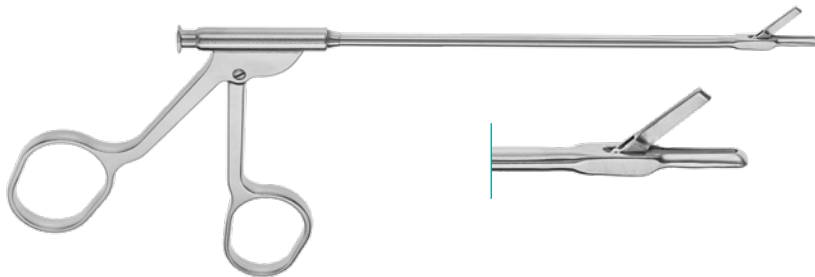

STRUYCKEN
Ethmoidal Forceps

130mm, 5 ¹ / ₈ "	252-003-130
--	-------------

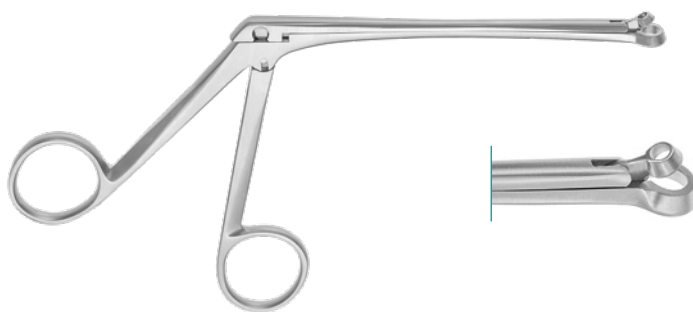

HARTMANN
Nasal Cutting Forceps, through-cutting,
120mm, 4³/₄"

5mm	420-407-005
7mm	420-407-007
9mm	420-407-009
11mm	420-407-011

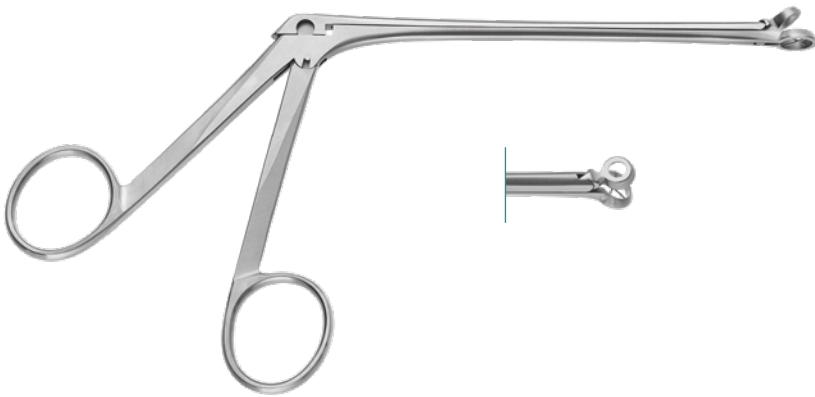
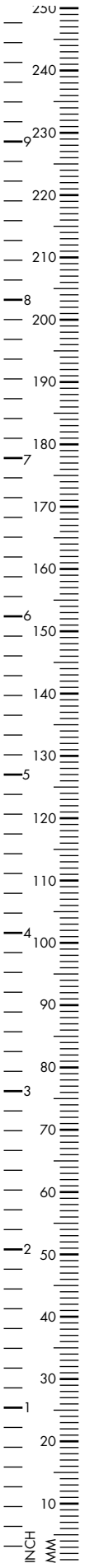

MELZER

Adenoid Punch, through cutting,
round, with basket, 140mm, 5¹/₂"

Fig. 1, 7mm	420-401-001
Fig. 2, 8mm	420-401-002

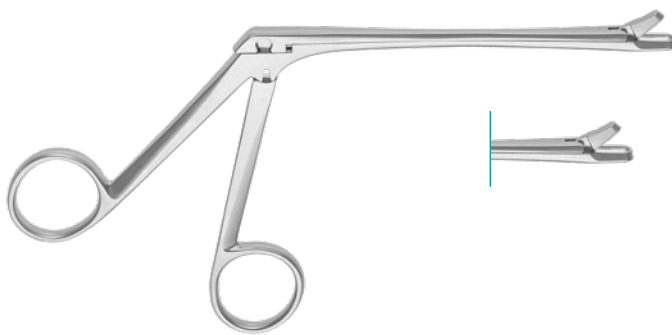

GRUENWALD-HENKE

Nasal Cutting Forceps, through-cutting,
120mm, 4³/₄"

Fig. 1, 3.5 x 11mm	420-405-120
Fig. 2, 2.0 x 9.5mm	420-406-120

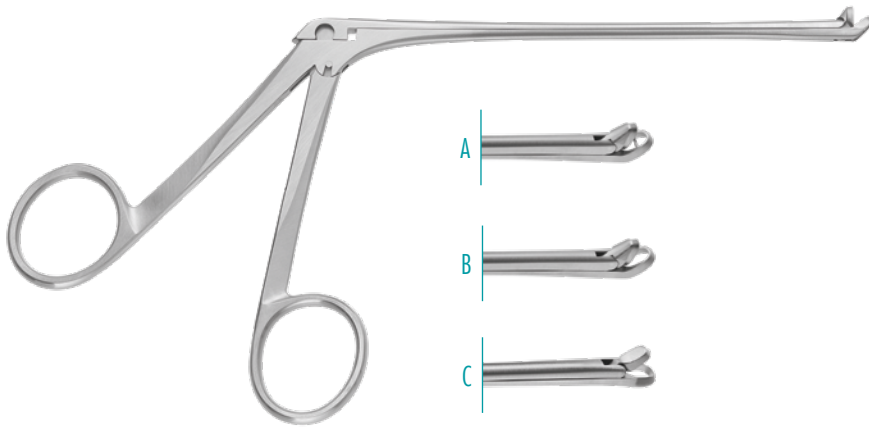
**WATSON-WILLIAMS**

Nasal Forceps, through-cutting, upcurved,
3mm bite, 140mm, 5¹/₂"

A	420-418-140
B	420-419-140
C	420-420-140

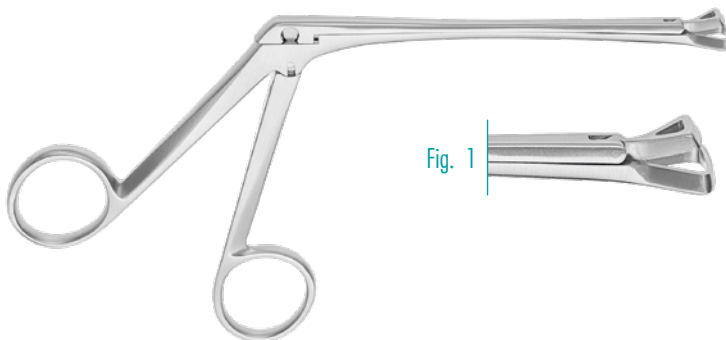
**SCHMEDEN**

Nasal Cutting Forceps, through-cutting,
120mm working length, 190mm, 7¹/₂"

Fig. 1	420-401-190
Fig. 2	420-402-190

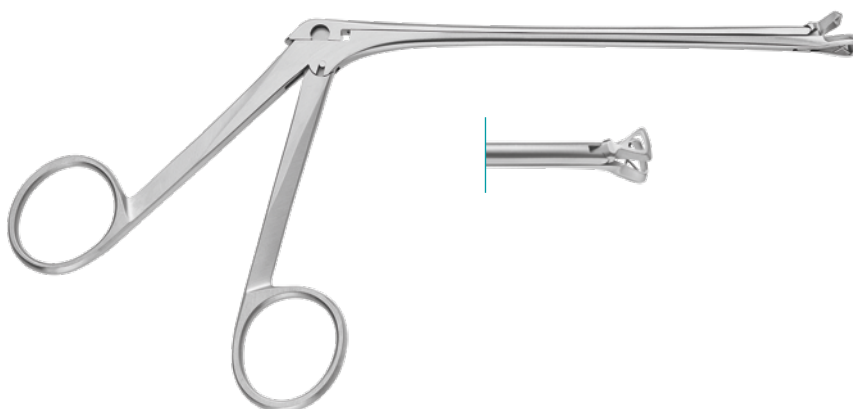
**MELZER**

Adenoid Forceps, through-cutting, triangular,
140mm, 5¹/₂"

Fig. 0, 6mm	420-401-100
Fig. 1, 7mm	420-401-101
Fig. 2, 8mm	420-401-102
Fig. 3, 10mm	420-401-103

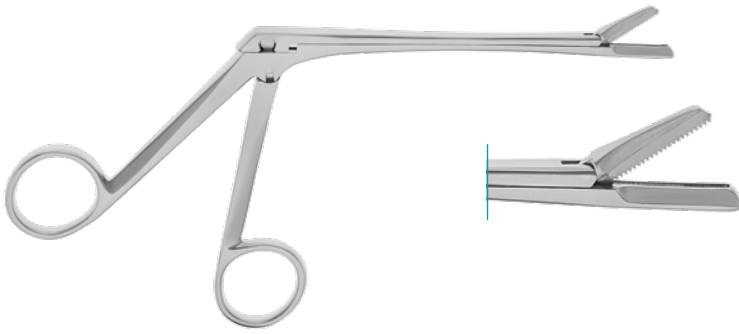
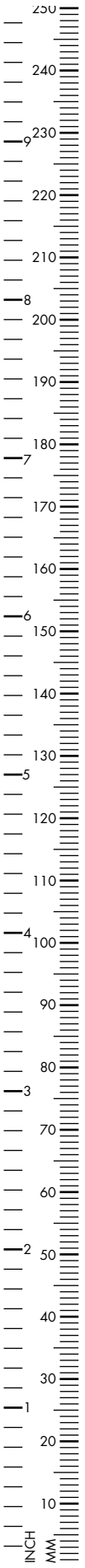

STRUYCKEN

Nasal Cutting Forceps, through-cutting

120mm, 4^{3/4}"

420-409-120

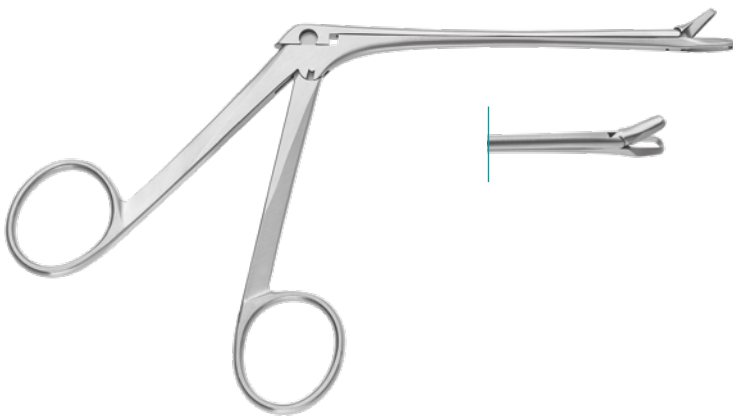

GRUENWALD

Nasal Forceps, oval bite, 115mm, 4^{1/2}"

Fig. 1, 3.0mm

420-421-001

Fig. 2, 3.5mm

420-421-002

Fig. 3, 4.0mm

420-421-003

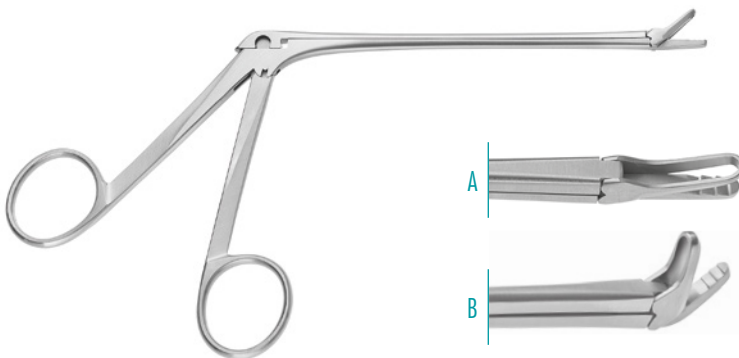

MYLES

Nasal Cutting Forceps, through-cutting,
130mm, 5^{1/8}"

A straight, flat

420-410-140

B 30° upcurved

420-413-140

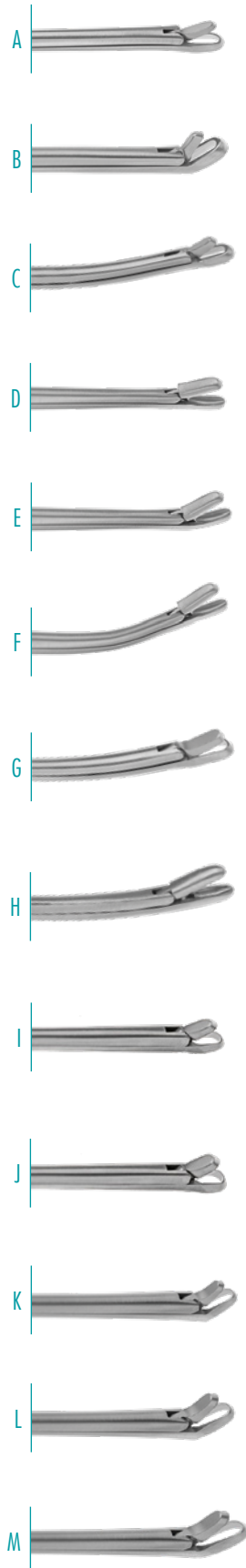
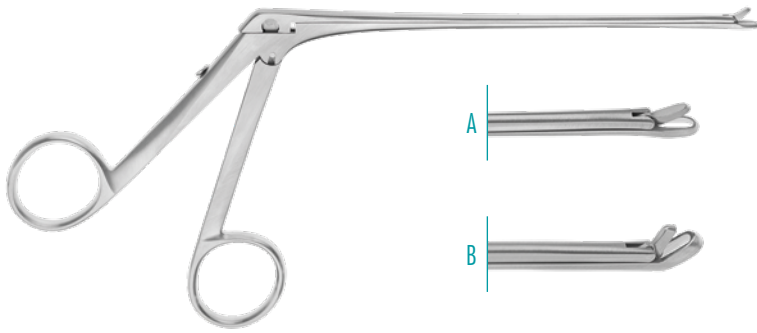
**MORIYAMA**Conchotom, through-cutting, 140mm, 5¹/₂"

A	Size 1, straight, delicate	252-200-001
B	Size 2, upcutting, delicate	252-200-002
C	Size 3, shaft upcurved, delicate	252-200-003
D	Size 4, straight, oval cups, delicate	252-200-004
E	Size 5, upwards, oval cups, delicate	252-200-005
F	Size 6, shaft upcurved, oval cups, delicate	252-200-006
G	Size 8, sheath upcurved	252-200-008
H	Size 9, shaft upwards, oval cups	252-200-009
I	Size 10, straight, small size, 115mm, 4 ¹ / ₂ "	252-200-010
J	Size 11, straight, large size, 115mm, 4 ¹ / ₂ "	252-200-011
K	Size 12, upwards, small size, 115mm, 4 ¹ / ₂ "	252-200-012
L	Size 13, upwards, medium size, 115mm, 4 ¹ / ₂ "	252-200-013
M	Size 14, upwards, large size, 115mm, 4 ¹ / ₂ "	252-200-014

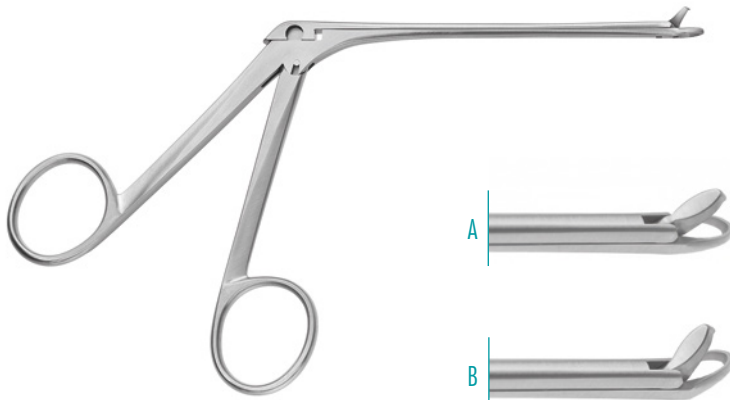
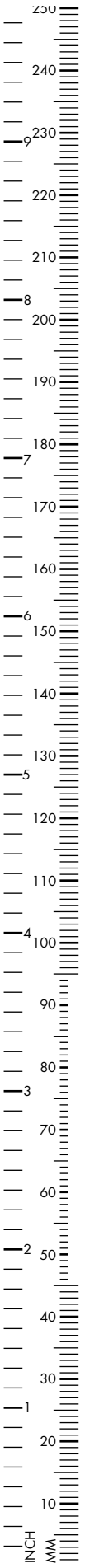

smooth

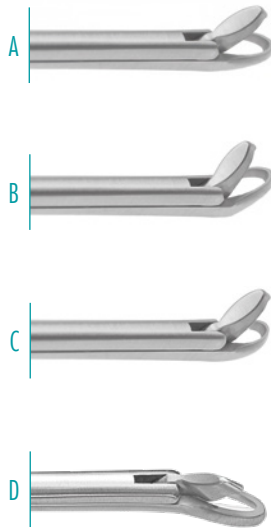

BLAKESLEY

Nasal Forceps, through cutting, smooth, 115mm, 4 1/2"

A straight

2.0mm bite	252-200-110
2.5mm bite	252-200-111
3.0mm bite	252-200-112
3.5mm bite	252-200-113
4.0mm bite	252-200-114
5.0mm bite	252-200-115

B upcurved

2.0mm bite	252-201-110
2.5mm bite	252-201-111
3.0mm bite	252-201-112
3.5mm bite	252-201-113
4.0mm bite	252-201-114
5.0mm bite	252-200-115

C left curved

2.5mm bite	252-202-111
------------	-------------

D right curved

2.5mm bite	252-203-111
------------	-------------

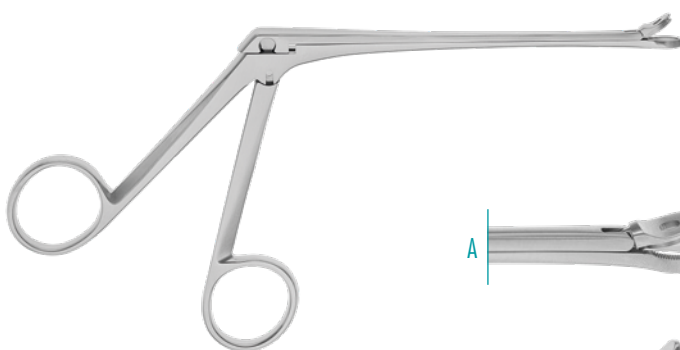

serrated

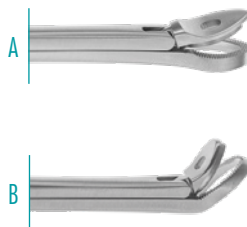

BLAKESLEY

Nasal Forceps, through cutting, serrated, 115mm, 4 1/2"

A straight

2.0mm bite	252-204-110
2.5mm bite	252-204-111
3.0mm bite	252-204-112
3.5mm bite	252-204-113
4.0mm bite	252-204-114

B upcurved

2.0mm bite	252-205-110
2.5mm bite	252-205-111
3.0mm bite	252-205-112
3.5mm bite	252-205-113
4.0mm bite	252-205-114

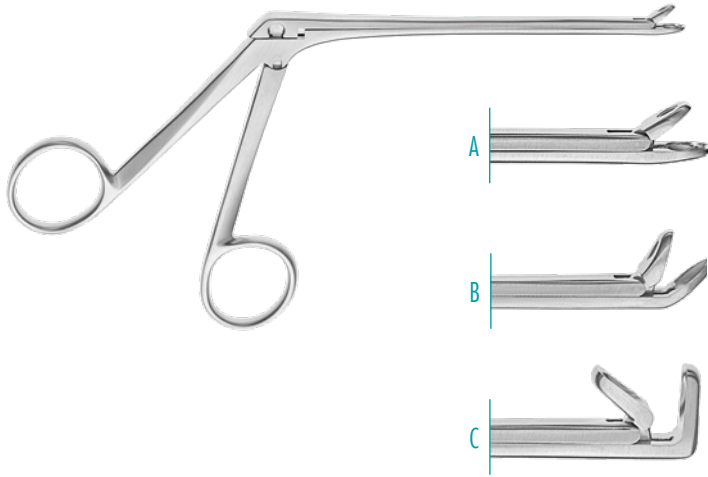

WEIL-BLAKESLEY

Ethmoidal Forceps, oval cup, fenestrated jaws, 120mm, 4"

A straight

Fig. 0, 3.0mm	252-000-120
Fig.1, 3.6mm	252-001-120
Fig.2, 4.2mm	252-002-120
Fig.3, 4.8mm	252-003-120
Fig.4, 5.6mm	252-004-120

B upwards curved

Fig. 0, 3.0mm	252-000-121
Fig.1, 3.6mm	252-001-121
Fig.2, 4.2mm	252-002-121
Fig.3, 4.8mm	252-003-121
Fig.4, 5.6mm	252-004-121

C 90° upwards curved

Fig. 0, 3.0mm	252-000-122
Fig.1, 3.6mm	252-001-122
Fig.2, 4.2mm	252-002-122
Fig.3, 4.8mm	252-003-122
Fig.4, 5.6mm	252-004-122

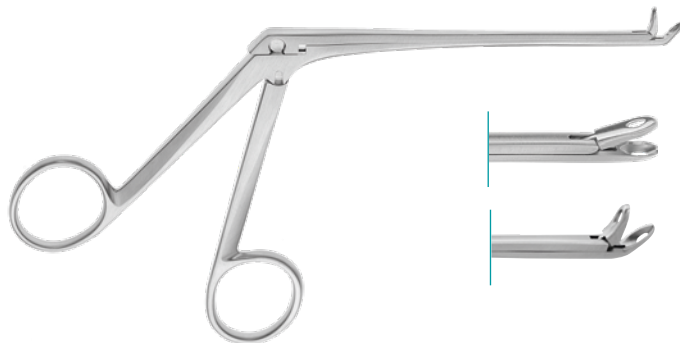

STRUEMPEL-VOSS

Ethmoidal Forceps, Ø2.5mm, 110mm, 4 1/3"

straight	252-144-121
upcurved jaws	252-000-111

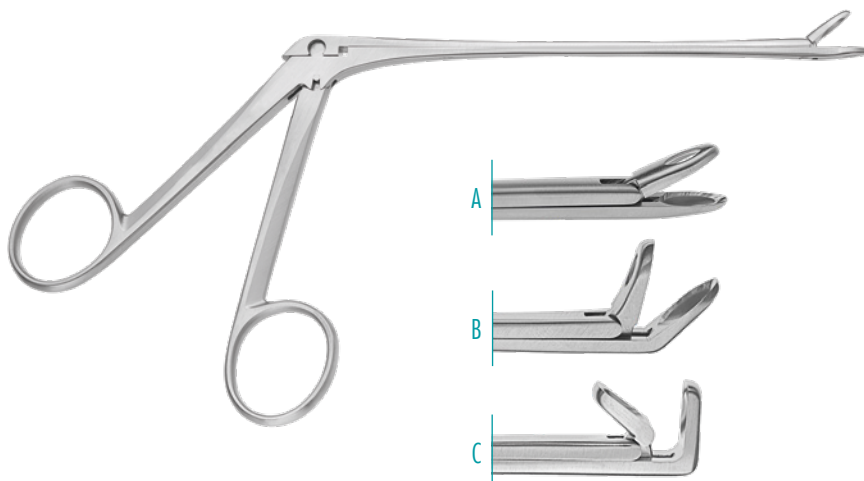

BLAKESLEY

Nasal Forceps, 150mm, 6"

A straight / 0°

Size 1, 3.5mm	252-035-150
Size 2, 4.0mm	252-040-150
Size 3, 5.0mm	252-050-150

B 45° upcurved

Size 1, 3.5mm	252-035-151
Size 2, 4.0mm	252-040-151

C 90° upcurved

Size 1, 3.5mm	252-035-152
Size 2, 4.0mm	252-040-152

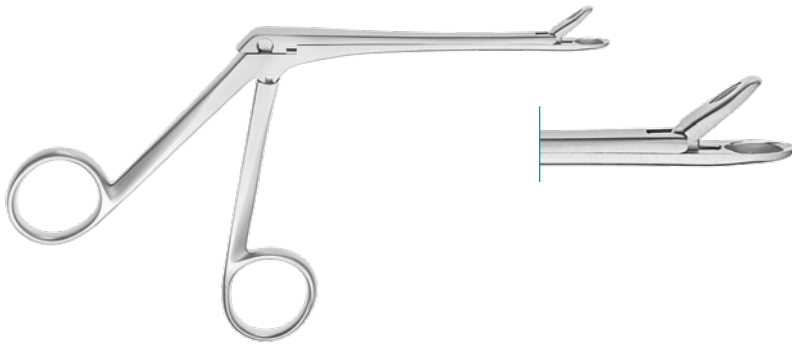
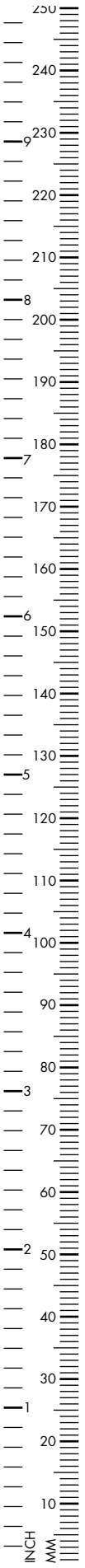

TILLEY HENCKEL

Ethmoid Punch, straight, 100mm, 4¹/₃"

Ø 4.5mm	252-022-045
Ø 5.5mm	252-022-055
Ø 6.5mm	252-022-065

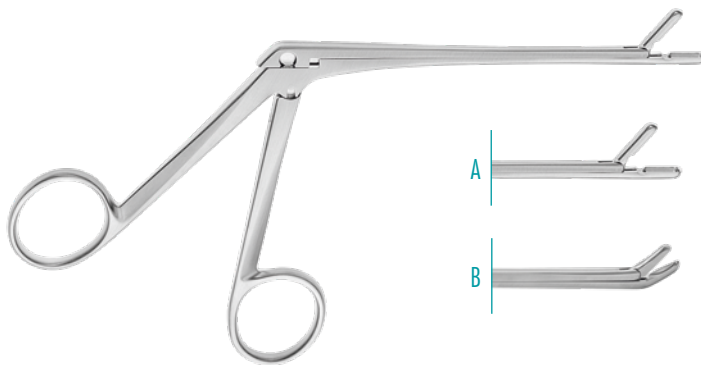

TAKAHASHI

Ethmoidal Forceps, oval, cup-shaped, 110mm, 4¹/₃"

A straight

2.5mm	252-410-130
3.0mm	252-410-131
4.0mm	252-410-132

150mm, 6"

3.0mm	252-410-151
-------	-------------

B upcurved, 110mm, 4¹/₃"

3.0mm	252-413-131
-------	-------------

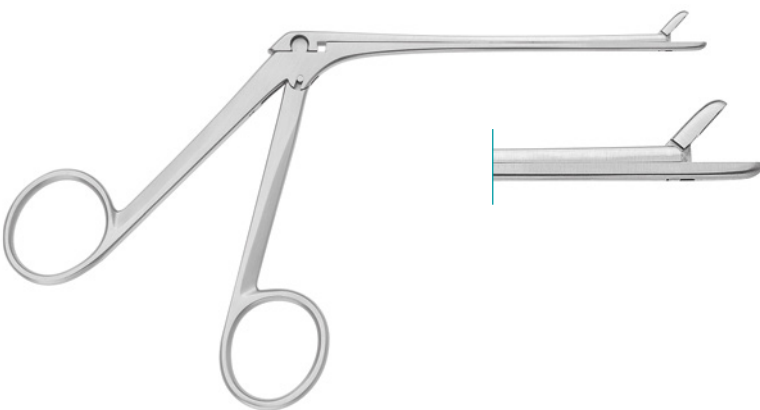

ST BARTS

Rongeur, 3mm, 110mm, 4¹/₃"

straight	252-536-115
curved up	252-537-115
curved down	252-538-115

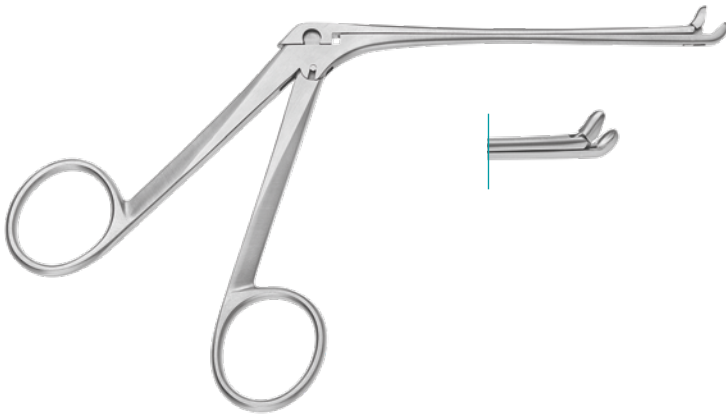
**BEAD**

Nasal Forceps, cup jaws, upturned

115mm, 4¹/₂"

252-425-115

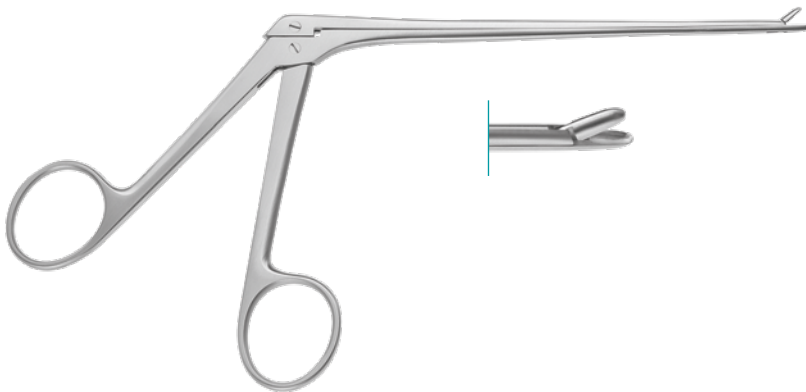

Ethmoidal Forceps, straight

140mm, 5¹/₂"

252-534-100

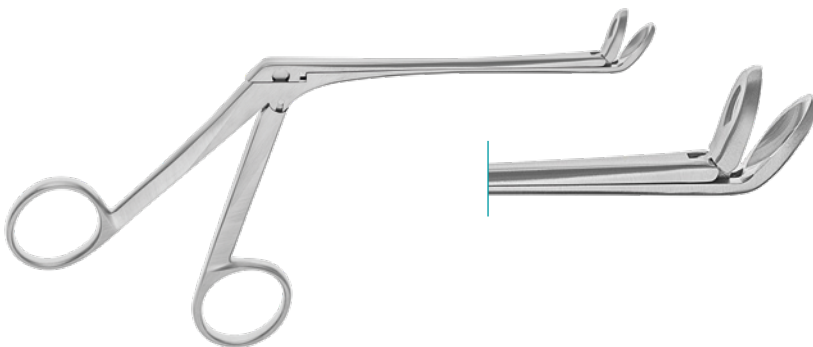
**BLAKESLEY**Conchotom with spoon, 6x14mm,
60° bent up115mm, 4¹/₂"

252-551-204

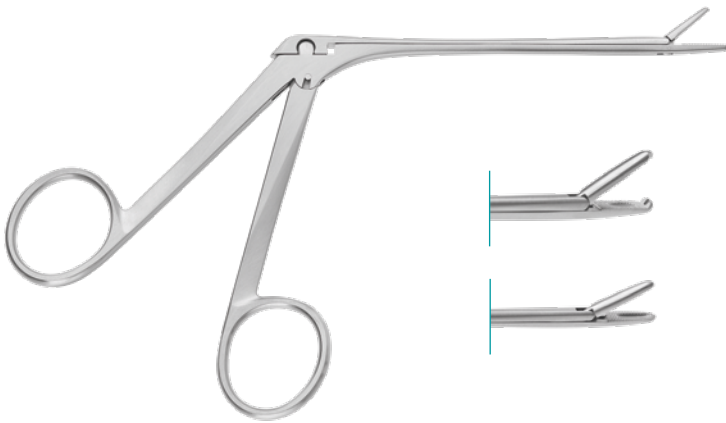
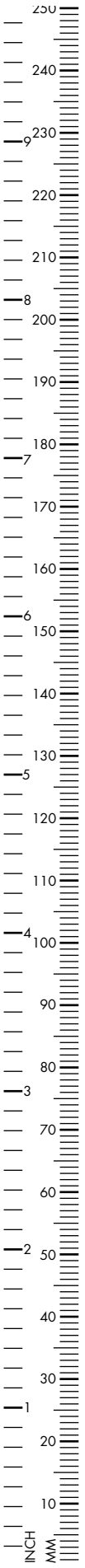

NOYES

Nasal Forceps, serrated jaws

serrated, 1x2 teeth	252-526-115
serrated	252-527-115

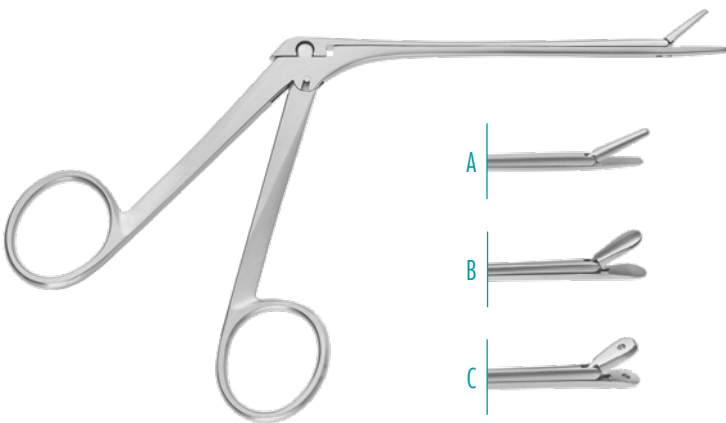

Nasal Forceps, serrated jaws

A MORGENSTEIN	252-528-115
B BLAKESLEY	252-529-115
C FERRIS-SMITH	252-530-115

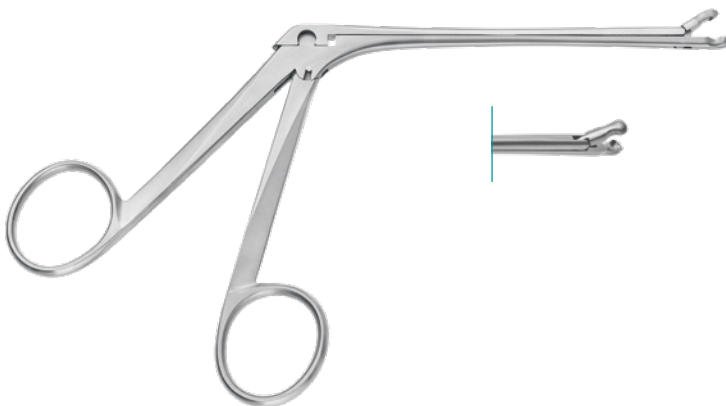

Sinus Cup Forceps, round cups, Ø 3.5mm

115mm, 4 1/2"	252-426-100
---------------	-------------

Zliders - slide to clean

The cleaning of complex surgical instruments requires different processes, compared to conventional reusable instruments. For the most difficult-to-clean instruments cleaning is done manually which makes it time and cost consuming.

The new solution to avoid complex and manual processes is the "one part detachable" instrument.



PRESS

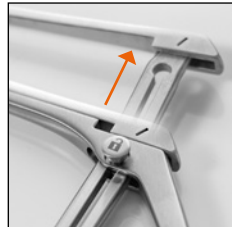

SLIDE



OPEN

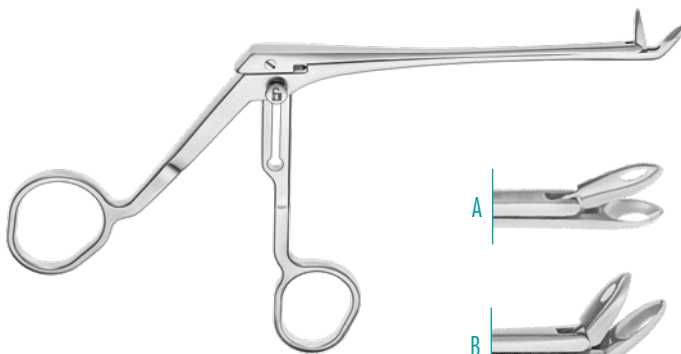

BLAKESLEY

Nasal Forceps, 120mm working length,

A straight

2.5mm	252-725-120
3.0mm	252-730-120
3.5mm	252-735-120
4.0mm	252-740-120
4.5mm	252-745-120

B 45° upwards

3.0mm	252-730-121
3.5mm	252-735-121
4.0mm	252-740-121

C 90° upwards

2.5mm	252-725-122
3.0mm	252-730-122
3.5mm	252-735-122
4.0mm	252-740-122

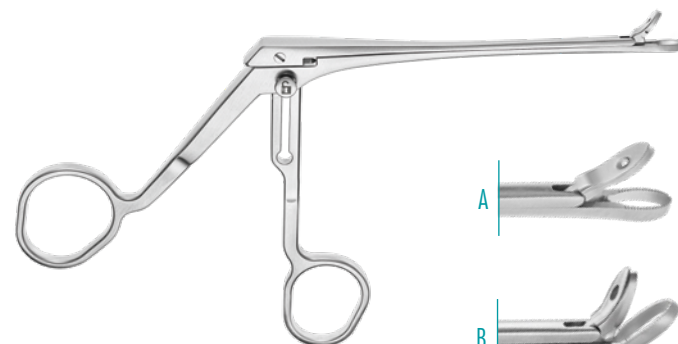

BLAKESLEY

Punch, 120mm working length,

A straight

1.9 x 4.0mm	252-720-120
2.5 x 6.0mm	252-726-120
3.0 x 7.0mm	252-731-120

B 45° upwards

1.9 x 4.0mm	252-721-120
2.5 x 6.0mm	252-727-120
3.0 x 7.0mm	252-732-120

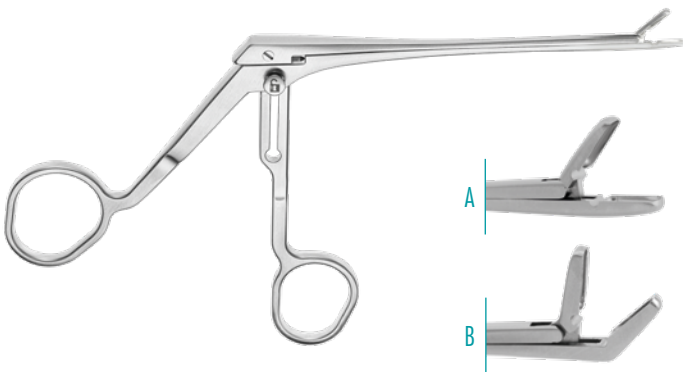
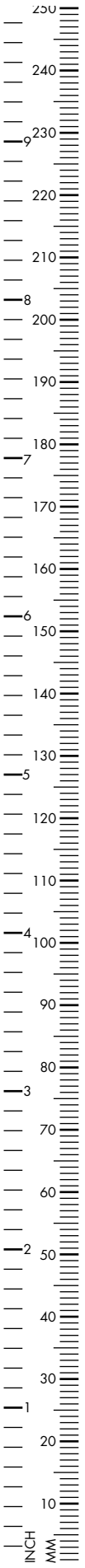

TAKAHASHI

Nasal Forceps, 125mm working length,

A straight

2.0 x 10.0mm	252-741-120
2.5 x 10.0mm	252-742-120
3.0 x 10.0mm	252-743-120
4.0 x 10.0mm	252-744-120

B 45° upwards, 120mm working length

2.0mm	252-741-121
2.5mm	252-742-121
3.0mm	252-743-121
4.0mm	252-744-121

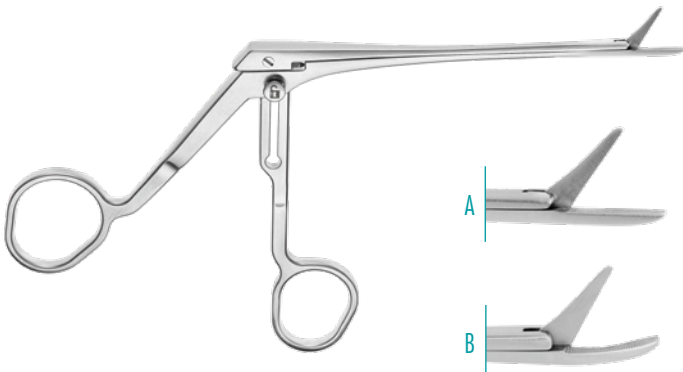

Nasal Scissors, 120mm working length,

A straight

4.0 x 3.0mm x 10.0mm	252-722-120
-------------------------	-------------

B right

4.0 x 3.0mm x 10.0mm	252-723-120
-------------------------	-------------

C left

4.0 x 3.0mm x 10.0mm	252-724-120
-------------------------	-------------

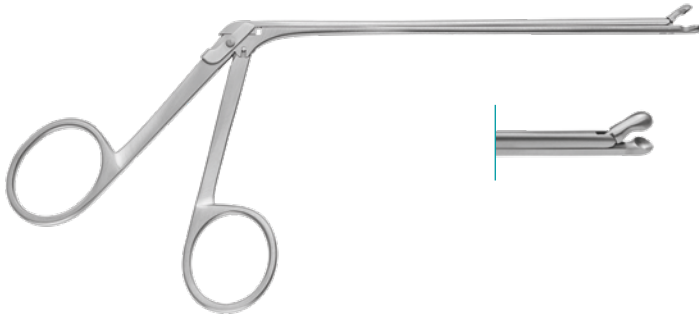
**HILDYARD**

Post-Nasal Forceps, 3.5mm biopsy cup

120mm, 4³/₄"

420-223-170

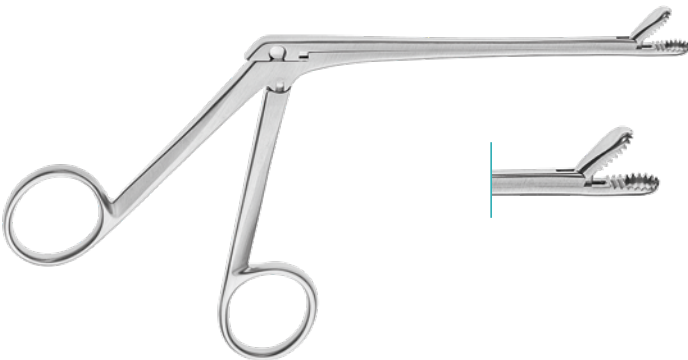
**WATSON-WILLIAMS**Ethmoidal Forceps for mucosa,
straight, serrated120mm, 4³/₄"

252-530-120

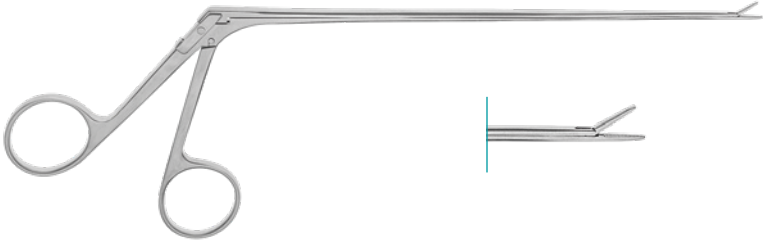
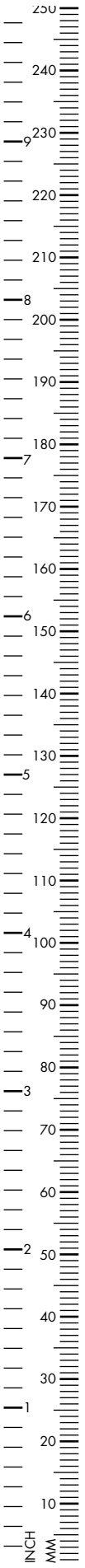

Grasping Forceps, fine serration

150mm, 6" 252-160-150

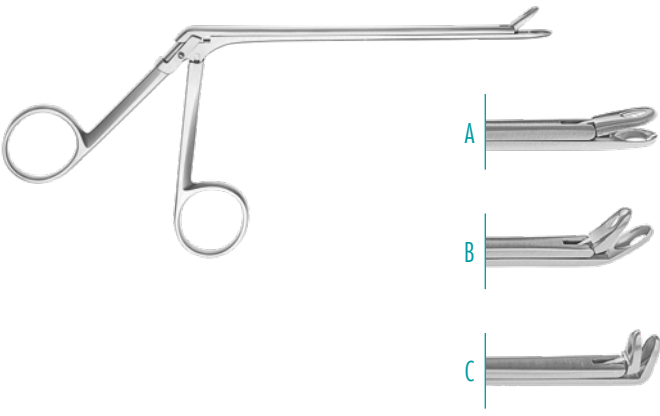

STRUEMPEL

Nasal Forceps with oval fenestrated cupped jaws, 100mm, 4"

- A straight 252-031-120
- B 45° angled up 252-032-120
- C 90° angled up 252-033-120



BELLUCCI

Scissors, straight

100mm, 4" 252-034-120

**WATSON-WILLIAMS**Ethmoidal Forceps, 115mm, 4^{1/2}"

Fig. 1, 6.5mm	252-529-120
Fig. 2, 9.5mm	252-531-120

**BRUENINGS**Septum Forceps, fenestrated, 190mm, 7^{1/2}"

Size 1, 6.5mm	252-028-001
Size 2, 7.5mm	252-028-002
Size 3, 9.0mm	252-028-003
Size 4, 10.0mm	252-028-004

**CRAIG**Septum Bone Cutting and Breaking Forceps, sharp cup, 6mm, 165mm, 6^{1/2}"

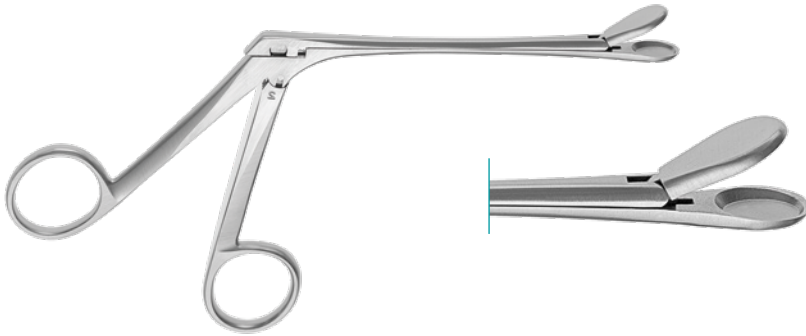
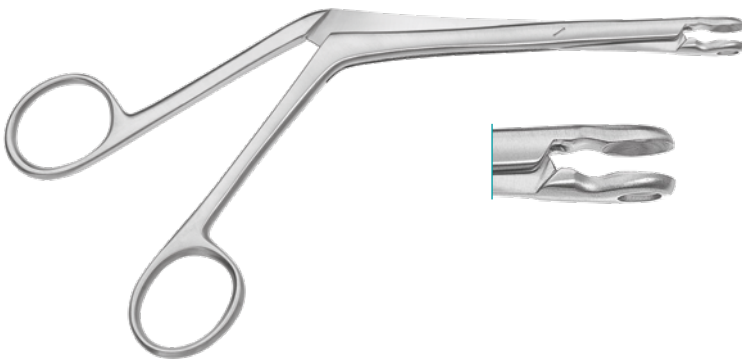
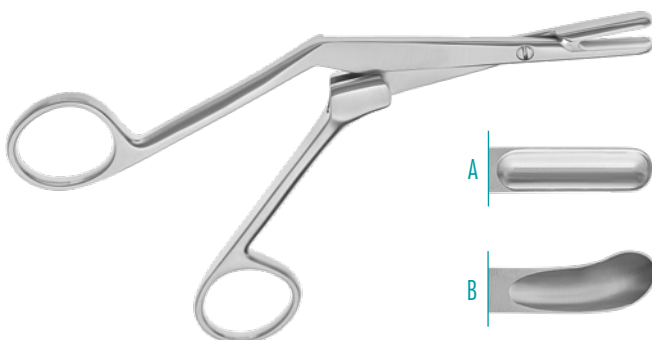
A straight

Oval cup 252-029-000

B curved left

252-029-500

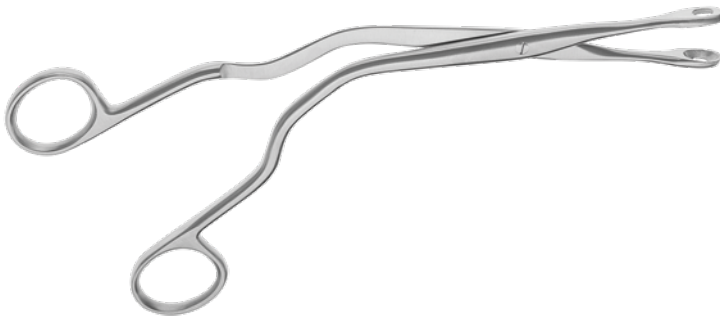
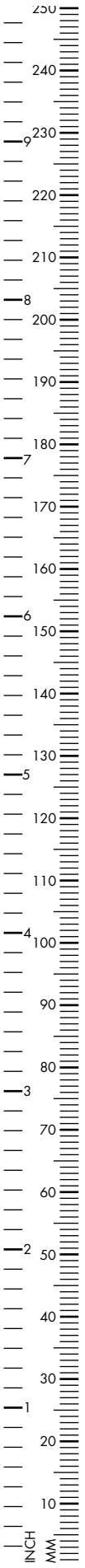

LUC

Septum Forceps with fenestrated jaws
190mm, 7¹/₂"

6.0mm	420-400-001
7.5mm	420-400-002



HEYMANN-KNIGHT

Septum Forceps, sharp oval cup

190mm, 7 ¹ / ₂ "	420-422-190
--	-------------



JANSEN-MIDDLETON

Nasal Forceps, 4x11mm, spoon jaws

170mm, 6 ² / ₃ "	252-032-190
--	-------------



JANSEN-MIDDLETON

Nasal Punch, through cutting, 210mm, 8¹/₄"

4 x 14mm	252-031-190
3 x 13mm	252-033-190

**BECKER**

Septum Scissors, double action, serrated

180mm, 7"

420-213-180

**CAPLAN**

Nasal Scissors, straight blade

220mm, 8^{2/3}"

120-286-220

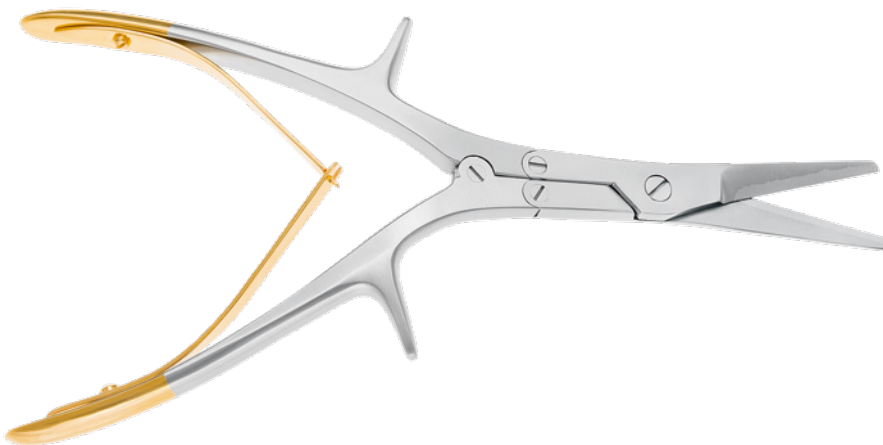
**GORNEY**

Nasal Scissors, straight blade

220mm, 8^{2/3}"

120-588-220

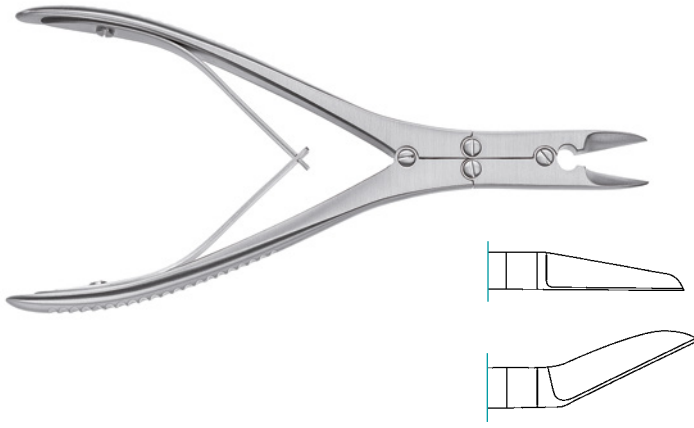
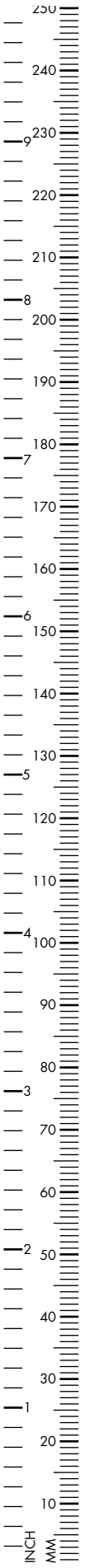

RUSKIN LISTON

Bone Cutting Forceps, double action,
170mm, 6²/₃"

straight	210-844-170
angled	210-843-170



MCINDOE

Bone Cutting Forceps, double action

175mm, 6 ⁷ / ₈ "	210-880-175
--	-------------

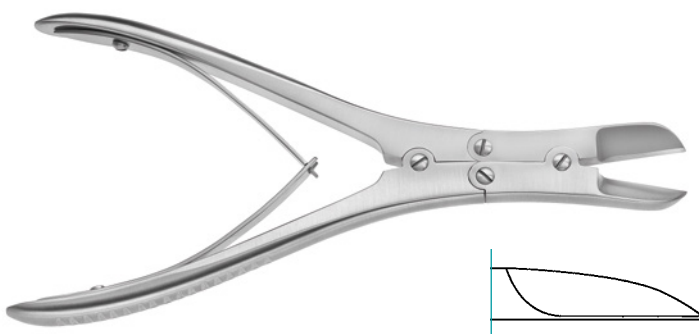

RUSKIN ROWLAND

Bone Cutting Forceps, double action, straight

180mm, 7"	210-855-180
-----------	-------------



GUASTELLA
Lateral Osteotomy Forceps
280mm, 11" 420-370-400



KRESSNER
Crushing Forceps, kee-bent, 220mm, 8²/₃"
3mm 420-408-003
4mm 420-408-004



RUBIN
Septum Morcelizer, double action,
straight
205mm, 8¹/₈" 420-370-210
angled



190mm, 7¹/₂" 420-371-210
Protection Cap 420-370-212



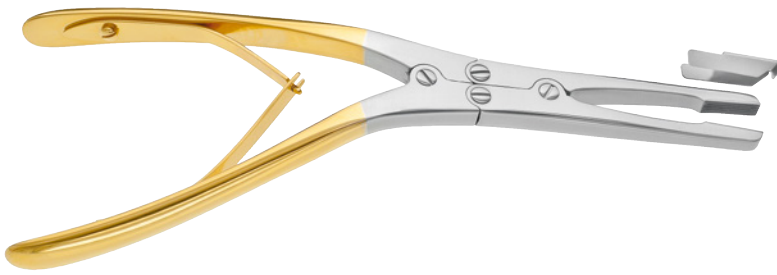
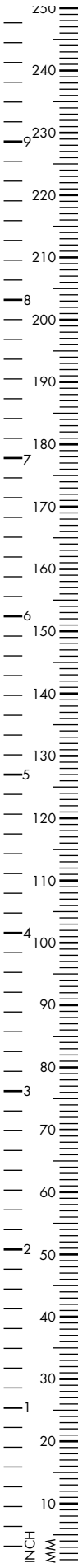

RUBIN
Septum Morselizer, double action, with guard
220mm, 8²/₃"

	420-220-220
Guard only	420-221-200

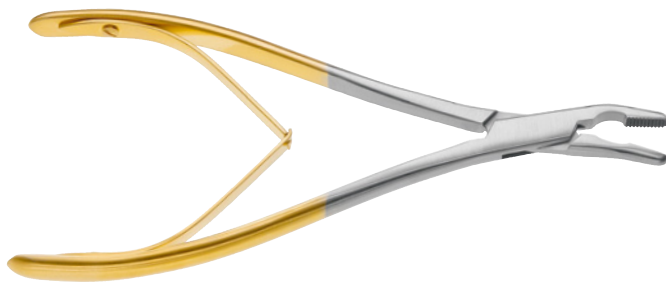

GUNTER
TC Lower Lateral Morselizer
180mm, 7"

	420-220-212
--	-------------



COTTLE-WALSHAM
Septum Forceps, aseptically lock
230mm, 9"

	420-450-230
--	-------------



COTTLE-WALSHAM
Septum Straightening Forceps, 230mm, 9"

A right	420-452-230
B left	420-451-230



**ASH**

Septum Straightening Forceps, curved

220mm, 8^{2/3}"

420-455-230

**BOIES**

Elevator for septum repositioning

170mm, 6^{2/3}"

420-557-170

**BOIES**

Nasal fracture elevator, 9mm tip

195mm, 7^{3/4}"

420-555-195

**GOLDMANN**

Septum elevator, round (displacer)

200mm, 8"

420-189-210

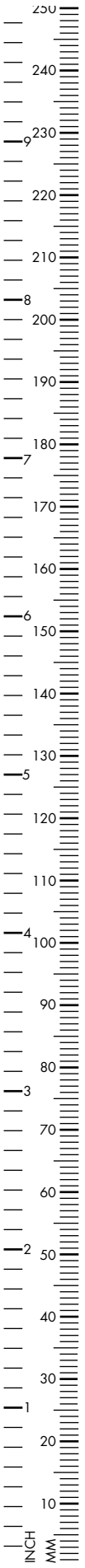

FREER
Mucosa Knife

150mm, 6" 420-195-150



COTTLE
Septum knife, stiff blade with rounded edge

140mm, 5 1/2" 420-213-140



JOSEPH
Button-End Knife, angled

165mm, 6 1/2" 420-209-175



JOSEPH
Nasal Knife, sharp, double-edge,
150mm, 6"

straight 420-190-003

curved 420-191-003



MASING
Cartilage Slitting Knife, curved blade, sharp

130mm, 5 1/8" 420-552-130



Skin Hook	
150mm, 6"	170-011-150



GRAEFF	
Micro Skin Hook, 125mm, 5"	
sharp	170-010-125



KILNER	
Skin Hook, sharp	
150mm, 6"	230-203-150



GILLIES	
Skin Hook, 180mm, 7"	
A small	230-205-180
B medium	230-207-180
C large	230-209-180

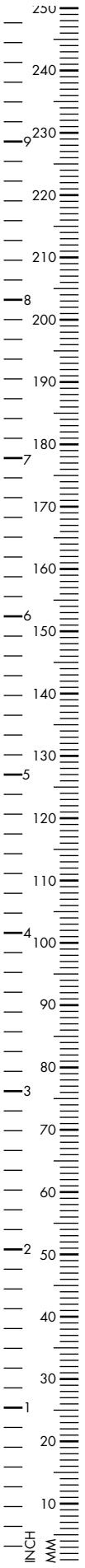

COTTLE

Nerve Hook, 168mm, 6²/₃"

180° retrograde curved 230-286-160

120° retrograde curved 230-285-160



FISCH

Hook, 90°, sharp, angled

185mm, 7¹/₄" 250-064-376

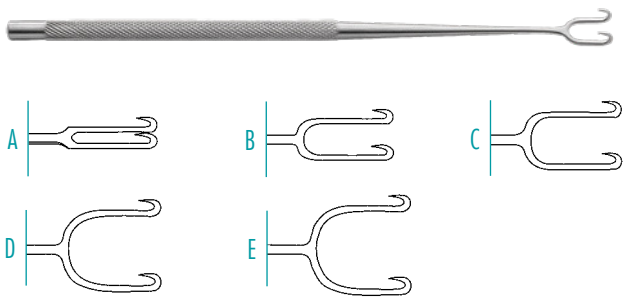

JOSEPH

Skin Hook, 2 prongs, 160mm, 6¹/₄"

A 2mm wide 170-014-002

B 5mm wide 170-014-005

C 7mm wide 170-014-007

D 10mm wide 170-014-010

E 12mm wide 170-014-012



Thumb Retractor, sharp, double hook, 8mm wide
 38mm working length 170-008-381



FREER
 Skin hook, 2 prongs, sharp
 150mm, 6" 230-220-001



COTTLE
 Nasal Retractor, 10mm wide
 130mm, 5¹/₈" 420-187-130

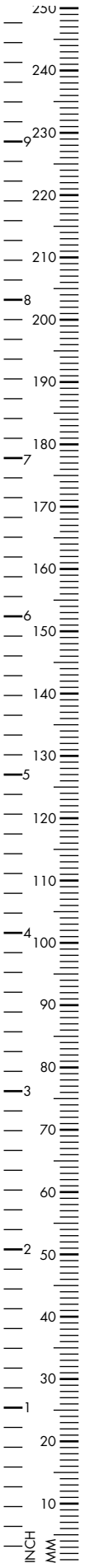

FOMON

Alar Retractor, 2 buttoned prongs

160mm, 6^{1/4}" 230-280-160



FOMON

Alar Retractor, 2 buttoned prongs, insulated end

160mm, 6^{1/4}" 230-780-160



COTTLE

Alar Retractor, 2 prongs, 140mm, 5^{1/2}"
blunt/sharp

buttoned right 230-281-140

sharp/blunt

buttoned left 230-282-140

sharp/sharp

230-283-140



MASING

Alar Retractor, 6 x 12mm,
140mm, 5^{1/2}"

420-520-140

insulated 420-520-141



COTTLE

Alar Retractor, 10 x 12mm,
140mm, 5^{1/2}"

420-523-140

insulated 420-523-141

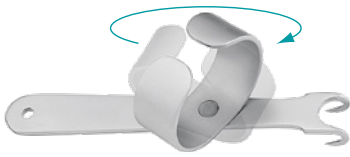
**RZ-NOSE**

RZ Nasal Retractor with Thimble Hook,
swivelling

85mm, 3 ¹ / ₃ "	260-200-110
---------------------------------------	-------------

**KILNER**

Alar Retractor, 2 prongs, 10mm wide,
85mm, 3¹/₄"

sharp	420-184-100
-------	-------------

blunt	420-185-100
-------	-------------

**KILNER**

Alar Retractor, 2 sharp prongs, 13mm wide

85mm, 3 ¹ / ₄ "	420-184-130
---------------------------------------	-------------

**RUBIN**

Hook, 7 x 5.5mm

sharp	420-187-155
-------	-------------

blunt	420-187-255
-------	-------------

**CONVERSE**

Alar Retractor, double-ended, 120mm, 4³/₄"

sharp	260-502-120
-------	-------------

blunt	260-501-120
-------	-------------

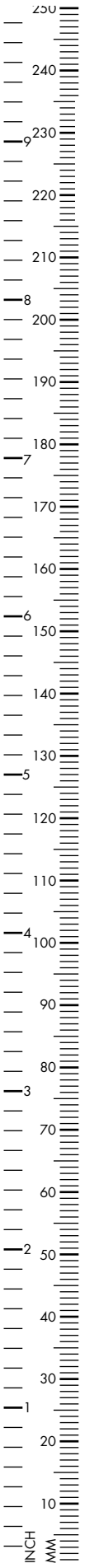

HARALD

Retractor, double-ended

420-186-140



KILNER

Double Hook

420-186-100



COTTLE-NEIVERT

Alar Retractor, saw and knife guide, 2 prongs, blunt

200mm, 8"

230-260-200



NEIVERT

Nasal Retractor, double-ended, with knife guide

160mm, 6 1/4"

170-036-180

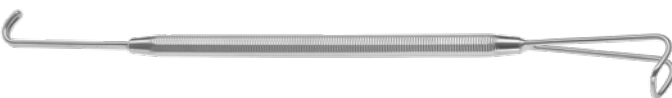

NEIVERT-RETTINGER

Nasal Hook

13mm

170-036-183

17mm

170-036-187

**WALTER**

Nasal Hook, 2 blunt prongs and blunt blade

135mm, 5¹/₃" 420-256-135**AUFRICHT**

Double-Ended Nasal Retractor, blunt

5mm / 42 x 7mm 420-260-005

8mm / 38 x 7mm 420-260-008

13mm / 38 x 7mm 420-260-013

13mm / 42 x 10mm 420-260-113

**MALINIAC**

Nasal Retractor, 9 x 45mm

100mm, 4" 420-652-100

with fiber optic light carrier

100mm, 4" 420-752-100

**CONVERSE**

Nasal Retractor, 11x44mm

110mm, 4¹/₃" 420-235-110

with fiber optic light carrier

100mm, 4" 420-236-110

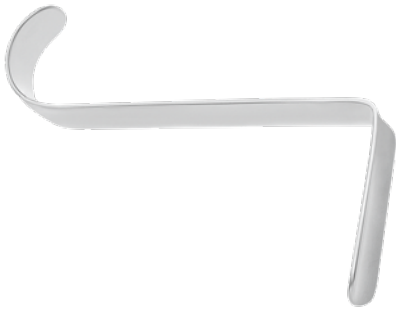
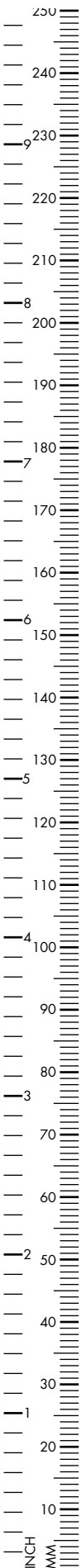
**CONVERSE**Nasal Retractor, 90mm, 3¹/₂"

10x20mm	420-237-095
12x30mm	420-238-095
12x40mm	420-239-090
12x50mm	420-239-095

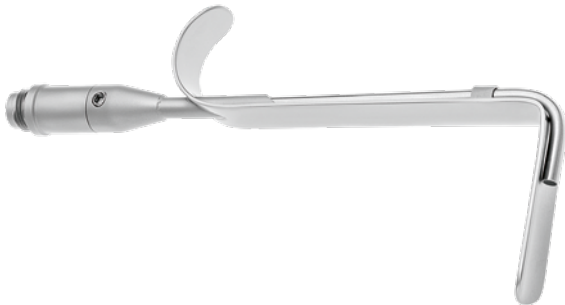
**CONVERSE**Nasal Retractor with fibre-optic light carrier, 90mm, 3¹/₂"

10x20mm	420-237-195
12x30mm	420-238-195
12x40mm	420-239-190
12x50mm	420-239-195

**AUFRICHT**Nasal Retractor, 160mm, 6¹/₄"

10 x 45mm	420-250-160
-----------	-------------

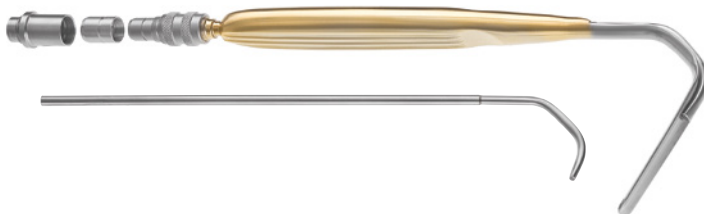
**AUFRICHT**

Nasal Retractor, with detachable fiber optic, 120°, 45mm blade

180mm, 7"	420-255-160
-----------	-------------



Dissector / Probe, double ended,
pointed tip / round cutting tip, 8mm

130mm, 5¹/₈" 420-546-130

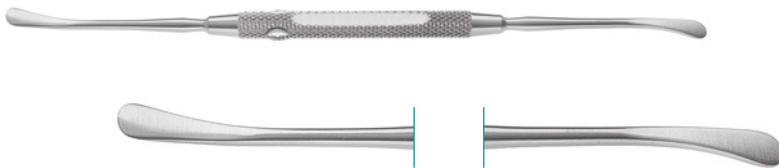

FREER

Septum Elevator, sharp/blunt, 5mm

185mm, 7¹/₄" 420-546-180

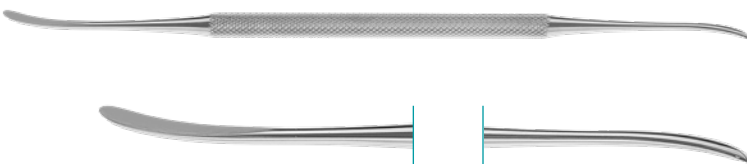

DANIEL

Elevator

420-546-200

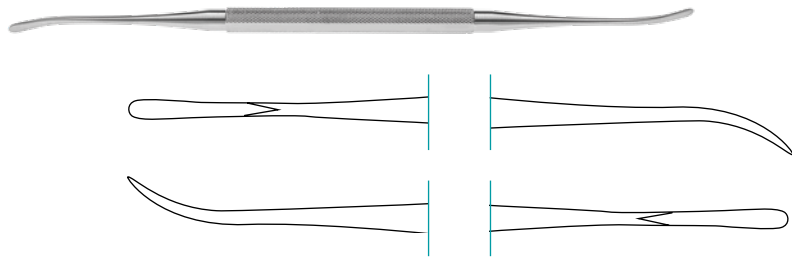
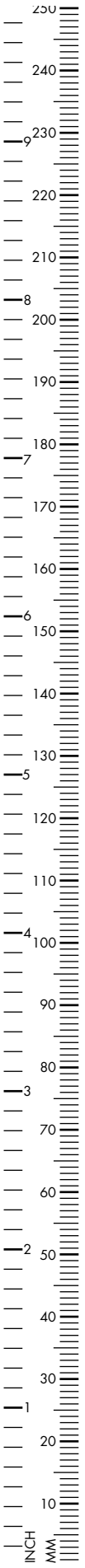

FREER-YASARGIL

Dissector, sharp

190mm, 7¹/₂"

420-548-180



FREER

Septum Elevator, double-ended,
semi-blunt/blunt

200mm, 8"

252-001-200



KLEINERT-KUTZ

Elevator and Dissector, double-ended,
blade A: 4.5mm / blade b: 3.0mm

180mm, 7"

420-554-178

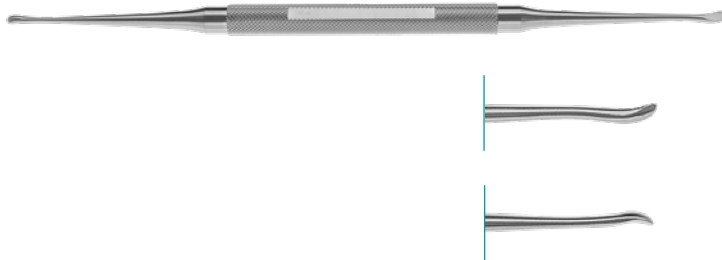

KLEINERT-KUTZ

Elevator and Dissector, double-ended,
blade A: 2.5mm / blade b: 3.0mm

190mm, 7¹/₂"

420-554-190

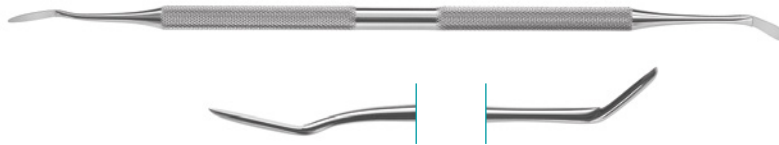
**FREER-LONG**Septum Elevator, double-ended,
sharp/sharp220mm, 8^{2/3}" 252-001-220**WOODSON**

Elevator, 2.4 / 4.0mm blade

200mm, 8" 420-556-200

**FREER-JOSEPH**

Septum Elevator, double-ended

200mm, 8" 420-555-200

**OBWEGESER-FREER**

Septum Elevator, double-ended

200mm, 8" 420-532-200

**HOWARTH**

Elevator, double-ended, sharp/blunt

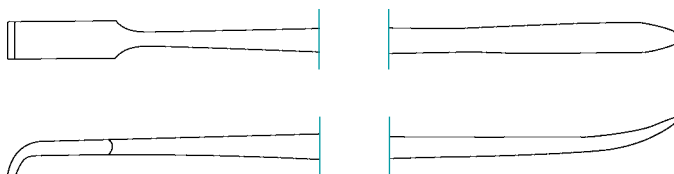
215mm, 8^{1/2}" 420-552-215

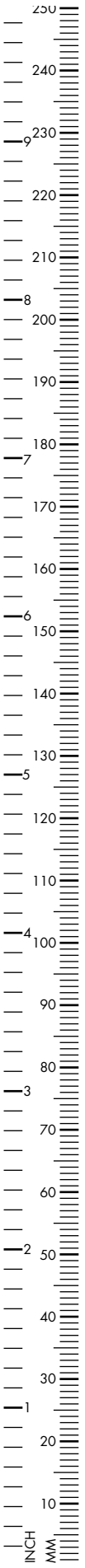

HARALDSSON

Suction Elevator

190mm, 7¹/₂"

420-390-190



RZ

Nasal Suction Dissector, Luer Lock,
Ø 8mm, 190mm, 7¹/₂"

sharp

420-310-190

blunt

420-311-190



NEGUS

Suction Dissector, blunt, 6mm

210mm, 8¹/₄"

420-395-205



GORNEY

Suction Raspatory, semi-sharp, 3mm

180mm, 7"

420-253-185

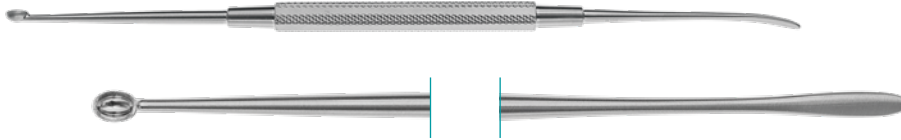
**CARTER**

Septum Elevator, double-ended

210mm, 8¹/₄"

420-551-210

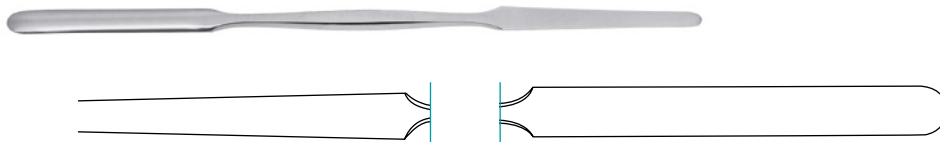
**KILLIAN**

Elevator, double-ended, sharp/blunt

185mm, 7¹/₄"

420-541-180

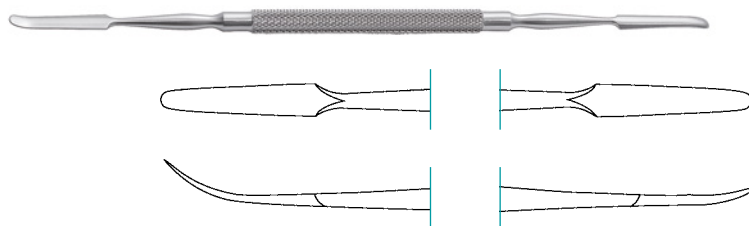
**KILLIAN**

Raspatory, 6mm, sharp/blunt

180mm, 7"

420-540-180

**KILLIAN**Septum double-ended elevator,
shuffle-shaped, sharp/blunt

180mm, 7"

252-002-180

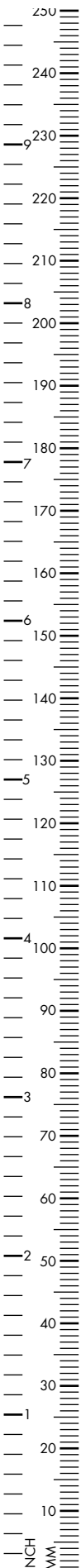
**MASING**

Elevator, double-ended, graduated, sharp/blunt

200mm, 8"

420-551-200

**COTTLE**

Periossteal Elevator, double ended, graduated

220mm, 8²/₃"

420-553-220

**JOSEPH**Masing Septum Elevator, bayonet shaped,
slightly curved210mm, 8¹/₄"

420-550-210

**COTTLE**Elevator, double-ended, graduated,
sharp/sharp

230mm, 9"

420-550-230

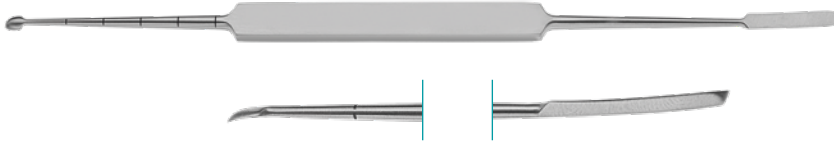
**COTTLE-JOSEPH**

Double Elevator

225mm, 8^{7/8}"

420-550-225

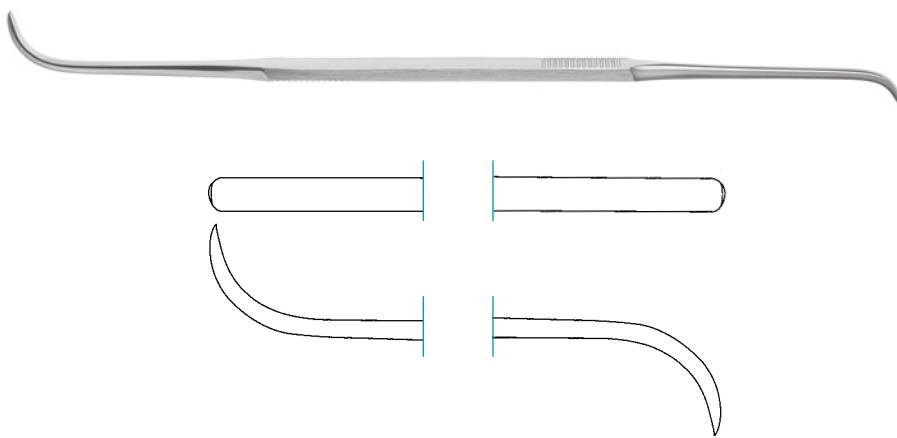
**COTTLE**

Elevator, double-ended, for tunneling

220mm, 8"

420-552-200

**PENNINGTON**

Elevator

210mm, 8^{1/4}"

420-543-210

**FREER**

Periosteal Elevator, double-ended, sharp

175mm, 6^{7/8}"

420-551-175

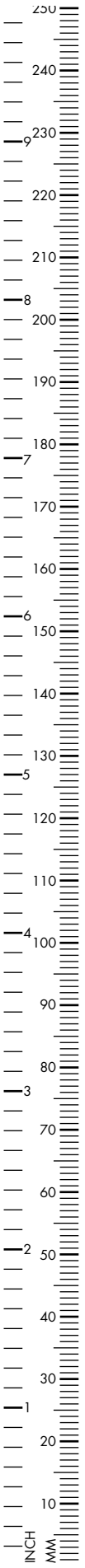

MCKENTY

Septum and Periosteal Elevator

220mm, 8²/₃"

420-539-220



MCKENTY

Raspatory, 150mm, 6"

4mm

420-547-004

5mm

420-547-005



JOSEPH

Periosteal elevator, slightly curved,

170mm, 6²/₃"

2mm

420-530-165

3mm

420-531-165

4mm

420-532-165

5mm

420-533-165

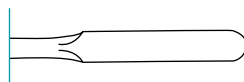

Raspatory, 170mm, 6²/₃"

6mm 210-439-006

8mm 210-439-008

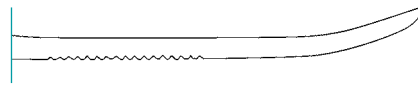
**PLESTER**

Raspatory, 8mm wide

180mm, 7" 410-336-180

**ERLANGEN**

Raspatory, 6mm wide, slightly curved

175mm, 6⁷/₈" 420-547-006**HALLE**

Raspatory, 4mm, blunt, slightly curved

180mm, 7" 420-544-165

**FREER**

Periosteal Elevator, 4mm

160mm, 6¹/₄" 420-551-180

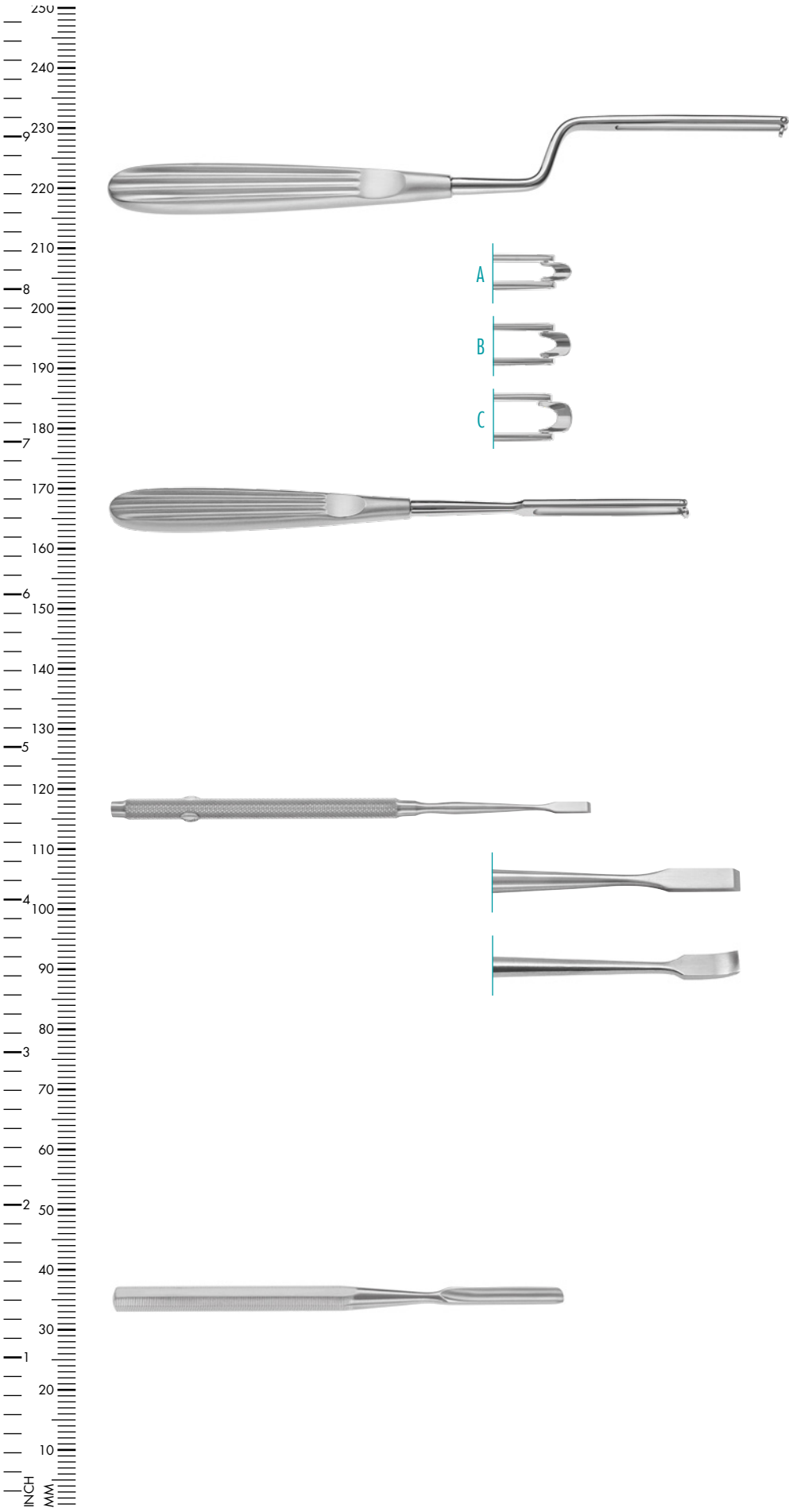

BALLENGER

Swivel knife, bayonet shaped, 210mm, 8¹/₄"

A 3mm	420-392-003
B 4mm	420-392-004
C 5mm	420-392-005

straight, 195mm, 7²/₃"

A 3mm	420-393-003
B 4mm	420-393-004
C 5mm	420-393-005

FREER

Septum Chisel, 4mm, 160mm, 6¹/₄"

straight	420-590-004
curved	420-591-004

FREER

Septum Gouge, straight, round cutting, 6mm

150mm, 6"	420-550-170
-----------	-------------

**BALLENGER**

Septum Gouge, with notch and cutting edge,
6mm

155mm, 6¹/₈" 420-595-170

**KILLIAN**

Septum Gouge, round cutting edge,
bayonet shaped, 6mm

170mm, 6²/₃" 420-552-170

**KILLIAN-CLAUS**

Septum Gouge with notch, bayonet shaped,
6mm

170mm, 6²/₃" 420-551-170

**COTTLE**

Chisel, graduated, 185mm, 7¹/₄"

3mm 210-488-003

4mm 210-488-004

6mm 210-488-006

7mm 210-488-007

9mm 210-488-009

12mm 210-488-012

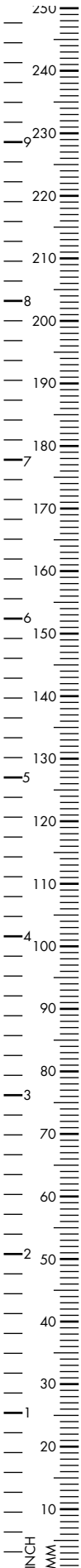

COTTLE

Chisel, curved, graduated, 6mm

180mm, 7" 210-486-006

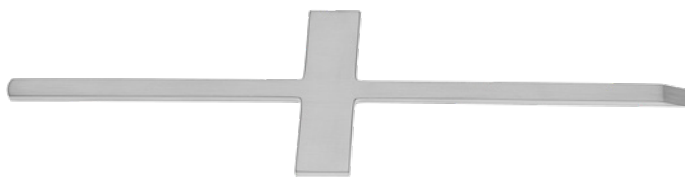

COTTLE

Chisel, 4mm

180mm, 7" 210-475-004



COTTLE

Osteotome with depth marking, 180mm, 7"

4mm 210-487-004

7mm 210-487-007

8mm 210-487-008

10mm 210-487-010

12mm 210-487-012



COTTLE

185mm, 7 1/4"

4mm 210-472-004

6mm 210-472-006

7mm 210-472-007

9mm 210-472-009

12mm 210-472-012

**COTTLE**

Fishtail Osteotome, protecting ends,
double guarded, 8mm

180mm, 7" 210-486-008

**COTTLE**

Osteotome with guard and crossbar, 5mm

185mm, 7¹/₄" 210-472-105

**COTTLE**

Fishtail osteotome, with crossbar,
with round cutting end, 16mm

180mm, 7" 210-486-016

**COTTLE-CINELLI**

Chisel, 185mm, 7¹/₄"

10mm 210-474-010

12mm 210-474-012

14mm 210-474-014

16mm 210-474-016

**CINELLI**

Osteotome, double guarded, straight
160mm, 6^{1/4}"

8mm	420-589-008
10mm	420-589-010
12mm	420-589-012
14mm	420-589-014
16mm	420-589-016

**RUBIN**

Osteotome, 167mm, 6^{2/3}"

8mm	420-587-008
10mm	420-587-010
12mm	420-587-012
14mm	420-587-014
16mm	420-587-016

**FANOUS-GUBISCH**

Osteotome, straight, 4mm wide, with guard,
200mm, 8"

straight	420-640-001
right curved	420-640-002
left curved	420-640-003

**ANDERSON-NEIVERT**

Osteotome, 3.5mm, 205mm, 8^{1/8}"

straight	420-639-001
curved right	420-639-002
curved left	420-639-003

**SILVER**Osteotome, slender model, 185mm, 7¹/₄"

straight	420-460-001
left	420-460-002
right	420-460-003

**SILVER**

Osteotome, with guard, straight, 180mm, 7"

straight	420-459-001
left curved	420-459-002
right curved	420-459-003

**MASING**

Osteotome, with guard, 180mm, 7"

straight	420-459-101
right curved	420-459-102
left curved	420-459-103

**FRENCHAY**

Nasal Chisel with guard 180mm, 7"

curved left	420-491-001
curved right	420-491-002
straight	420-491-000

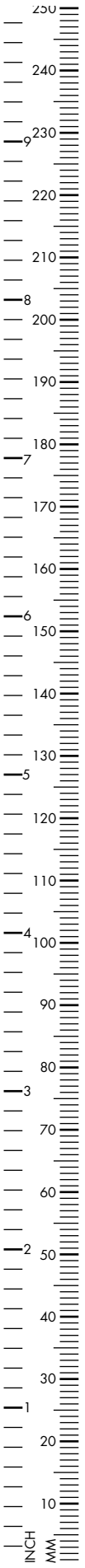

GUASTELLA

Osteotome, 180mm, 7"

left	420-472-002
right	420-472-003



MCINDOE

Osteotome, hard edge, mushroom head, 150mm, 6"

9mm	420-487-009
11mm	420-487-011
13mm	420-487-013
15mm	420-487-015



WALTER

Chisel with notch, double guarded, 190mm, 7 1/2"

3.0mm	420-582-003
4.5mm	420-582-045



WALTER

Osteotome, 190mm, 7 1/2"

A 2mm	420-580-002
B 3mm	420-580-003
C 4mm	420-580-004
D 7mm	420-580-007
E 9mm	420-580-009
F 12mm	420-580-012

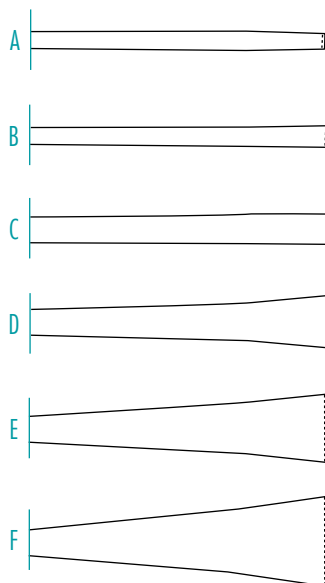

**SHEEHAN**Osteotome, 160mm, 6¹/₄"

2mm	420-594-002
3mm	420-594-003
4mm	420-594-004
5mm	420-594-005
6mm	420-594-006
8mm	420-594-008
10mm	420-594-010
12mm	420-594-012

**RZ OSTEOTOME**

Osteotome, 180mm, 7"

2mm	420-568-002
3mm	420-568-003
4mm	420-568-004
5mm	420-568-005
6mm	420-568-006
7mm	420-568-007

**SHEEHAN**Osteotome, 90mm, 3¹/₂"

1mm	420-594-002
-----	-------------

Mini Osteotome, CeraCut®, 175mm, 6⁷/₈"

2mm	420-702-175CC
3mm	420-703-175CC
4mm	420-704-175CC
6mm	420-706-175CC

**COTTLE**

Mallet, Ø 30mm, 1 side plain, 1 side convex
240g

190mm, 7¹/₂" 210-240-180

**LUCAE**

Mallet, Ø 19mm
190mm, 7¹/₂"

80g 210-230-190

140g 210-231-190

**COLLIN (LUCAE)**

Mallet, Ø 30mm
220g

200mm, 8" 210-220-200



Mallet, Ø 35mm, synthetic

240mm, 9¹/₂" 210-260-150



Mallet, anodized aluminium handle and head,
Ø 32mm
140g

225mm, 8⁷/₈" 210-264-220

Spare Discs, pair 210-264-221

**JOSEPH**Nasal Saw, 190mm, 7^{1/2}"

straight	230-202-000
bayonet shaped, curved left	230-202-001
bayonet shaped, curved right	230-202-002

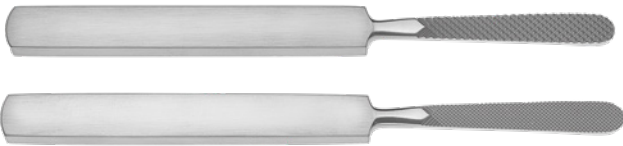
**JOSEPH**Nasal Rasp, cross-serrated, 160mm, 6^{1/4}"

fine	420-605-160
coarse	420-606-160

**MALTZ**

Rasp, straight, 180mm, 7"

backward cutting	420-654-180
forward cutting	420-657-180

**MCINDOE**

Nasal Rasp, straight, backward cutting

180mm, 7"	420-655-180
-----------	-------------

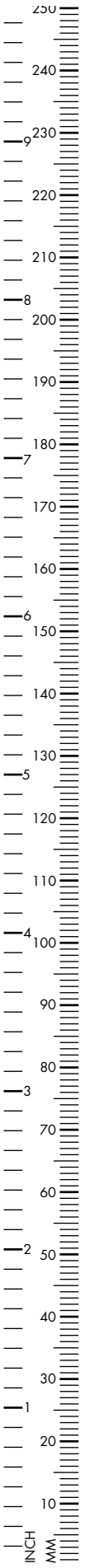

LEWIS

Nasal Rasp, 7mm wide tip

200mm, 8"

420-658-175



COTTLE

Nasal Rasp, backward cutting, straight

210mm, 8¹/₄"

420-670-210



AUFRICHT

Nasal Rasp, 90° cross-serrated,
9mm wide, 220mm, 8²/₃"

A backward cutting

420-650-001

B forward cutting

420-650-002

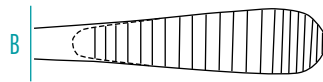
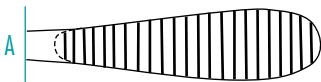

MILLER

Rasp, 90° cross-serrated, backwards cutting,
180mm, 7"

Fig. 1



Fig. 2



Fig. 3



Fig. 1 8mm / 5mm

500-387-000

Fig. 2 6mm / 4mm

500-384-010

Fig. 3 6mm / 5mm

500-386-045

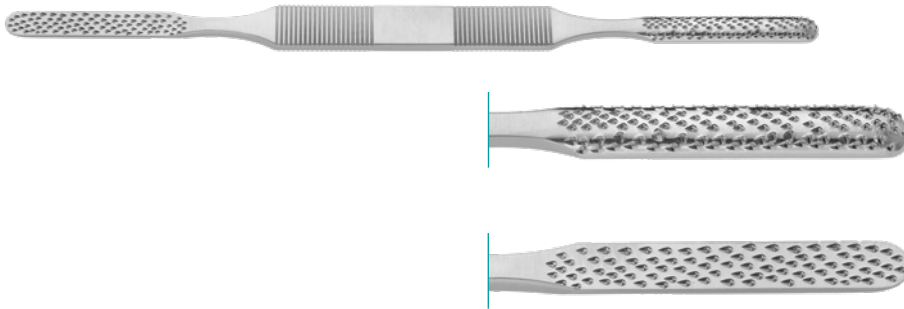

FOMON LIGHTWEIGHT

Rasp, double-ended, 7.0mm
215mm, 8¹/₂"

Coarse	420-662-001
Fine	420-662-002

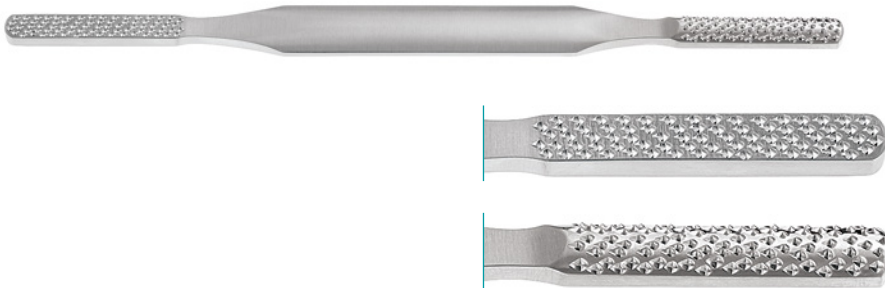

FOMON

Rasp, coarse, double-ended, 7.0mm / 8.0mm
215mm, 8¹/₂"

420-660-000

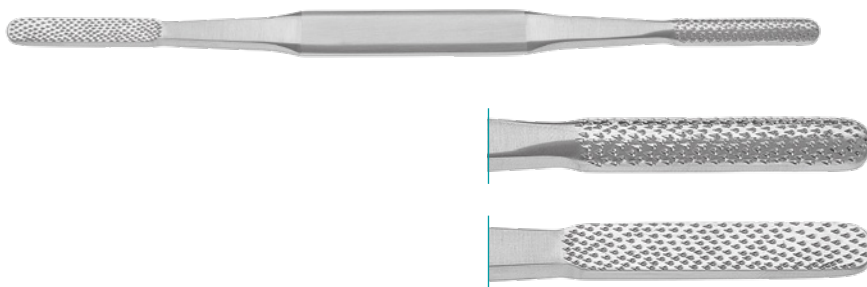

FOMON

Rasp, fine, round/flat
215mm, 8¹/₂"

420-661-000

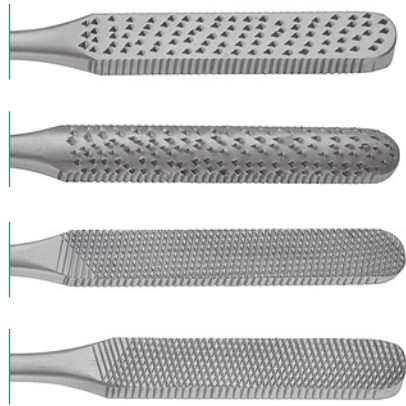
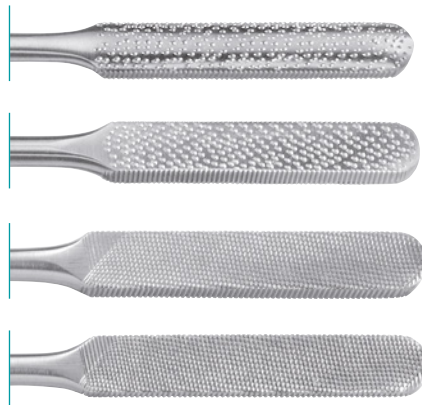
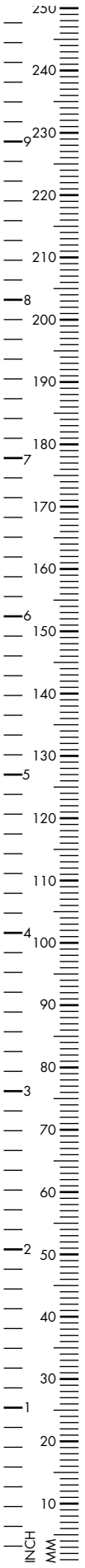

FOMON

Rasp, fine/coarse, double-ended, 4 sides

215mm, 8¹/₂"

420-661-100

KLEINERT KUTZ

Rasp, double-ended, 4 sides

220mm, 8²/₃"

420-656-000



MALTZ

Nasal Rasp, straight, backward cutting

180mm, 7"

420-672-000



MALTZ

TC Rasp,

165mm, 6 1/2"

Fig. 2

420-492-165

Fig. 3

420-493-165



PARKES

TC Rasp, straight, 8 x 39mm

210mm, 8 1/4"

Fig. 1

420-490-210

Fig. 2

420-491-210

Fig. 3

420-492-210

Fig. 4

420-493-210

Fig. 5

420-494-210



FOMON

TC Rasp, double-ended, 7 x 40mm

210mm, 8 1/4"

Fig. 1 / Fig. 2

420-660-219

Fig. 3 / Fig. 4

420-660-214

Fig. 5 / Fig. 6

420-660-216

Fig. 7 / Fig. 8

420-660-218

Fig. 9 / Fig. 10

420-660-200



Fig.1
0.8



Fig.2
1.1



Fig.3
1.3



Fig.4
1.6



Fig.5
1.8



Fig.6
2.0



Fig.7
2.4



Fig.8
2.6



Fig.9
2.8



Fig.10
3.0

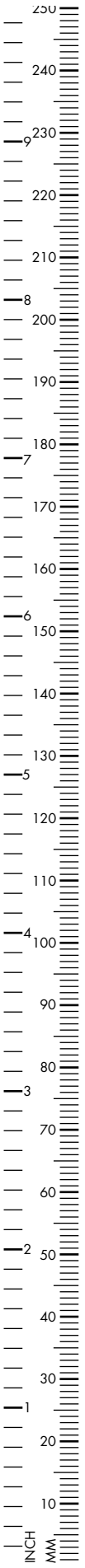

ASTON

Nasal Rasp, backward cutting, straight, 200mm, 8"

fine	420-480-200
coarse	420-488-200



AUFRICHT (PEET)

Nasal Rasp, 7 x 25mm fine, curved diamond jaws

200mm, 8"	420-650-101
-----------	-------------



PEET-COTTLE

Nasal Rasp, curved, diamond jaws

190mm, 7 1/2"	420-650-100
---------------	-------------

**PEET**

Convex Nasal Rasp, 25x8mm, straight
diamond jaws

190mm, 7^{1/2}"

420-650-050

**COTTLE**

Rasp, 7x33mm, straight
diamond jaws

200mm, 8"

420-675-200

**FOMON**

Rasp, double-ended, convex on flat,
diamond jaws, 7 x 40mm

210mm, 8^{1/4}"

420-653-000

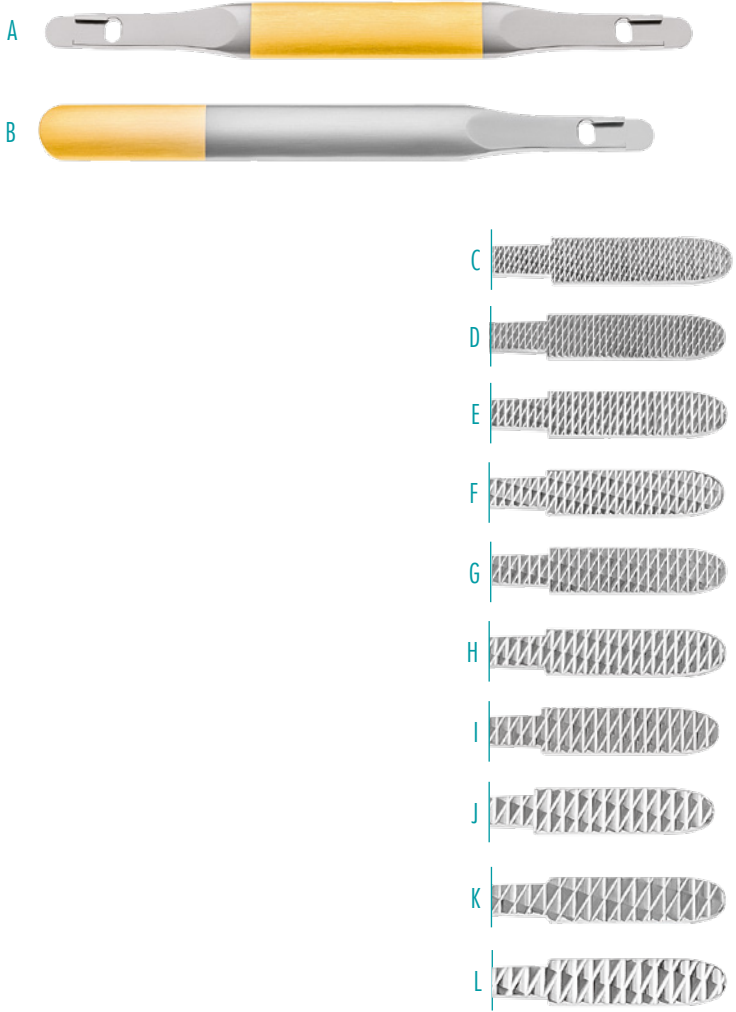
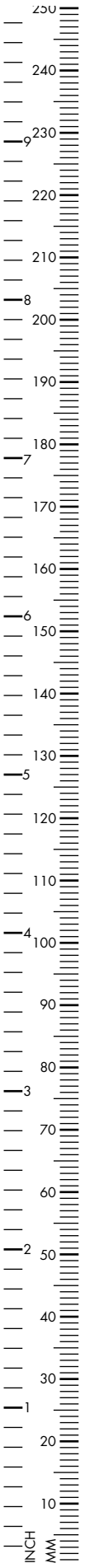

FOMON

Nasal Rasp Holder

A	double-ended	420-660-200
B	single-ended	420-660-100

FOMON

TC Insert

C	Fig. 1	420-660-101
D	Fig. 2	420-660-102
E	Fig. 3	420-660-103
F	Fig. 4	420-660-104
G	Fig. 5	420-660-105
H	Fig. 6	420-660-106
I	Fig. 7	420-660-107
J	Fig. 8	420-660-108
K	Fig. 9	420-660-109
L	Fig. 10	420-660-110

Fixation Key

M		420-660-150
---	--	-------------

TC Nasal Rasp Set, complete in sterilization tray, incl. 10 inserts, 1 key and 2 handles (single+double)

N		420-660-500
---	--	-------------



Wire Brush for cleaning rasps

165mm, 6 ¹ / ₂ "	260-500-001
--	-------------

**GIERTZ STILLE**

Rib Shears, double action

250mm, 9⁷/₈"

290-137-270

**DINGMANN**

Bone Holding Forceps, heavy pattern

190mm, 7¹/₂"

210-626-190

**LANGENBECK**

Bone Holding Forceps, 11mm wide

210mm, 8¹/₄"

210-722-210

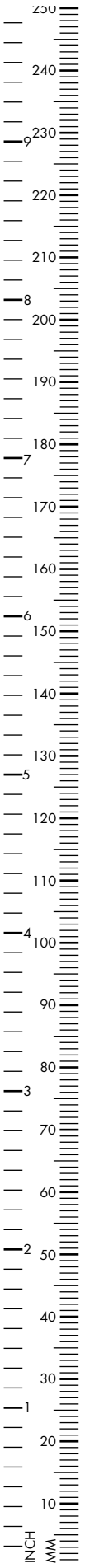

DOYEN

Rib Raspatory, 175mm, 6⁷/₈"

curved right	210-331-170
curved left	210-333-170



COTTLE

Bone Crusher with removal clip forceps,
28mm wide

420-365-000

Cartilage Crusher, 50mm wide

420-365-050

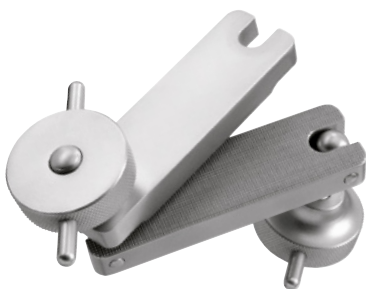

RZ

Cartilage Crusher

60 x 30mm	420-364-000
-----------	-------------

**TOLSDORF**

Bone crusher, inner part serrated, outer part
bottom plain, Ø 40mm

420-366-000



Plastic Plate, autoclavable

85 x 55mm 420-367-000



Plastic Plate, for preparation of bone grafts,
autoclavable

200x100x10mm 420-367-002

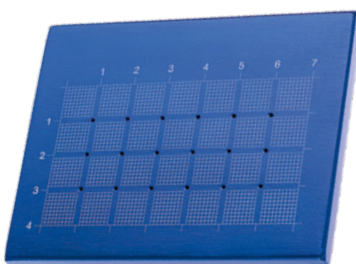
**SHEEN**

Cartilage Grid, aluminium, blue

70 x 40mm 260-761-000



Ruler, with mm inch markings

150mm, 6" 100-418-150

200mm, 8" 100-418-200

300mm, 12" 100-418-300

**CASTROVIEJO**

Caliper with locking screw, 0 - 15mm scale

70mm, 2³/₄"

400-583-005

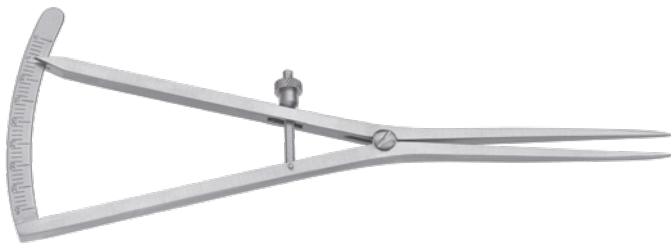
**CASTROVIEJO**

Caliper with locking screw

0 - 20mm,

400-583-007

85mm, 3¹/₄"

0 - 40mm,

400-583-008

180mm, 7"

**CASTROVIEJO**

Caliper with locking screw, angled,

0 - 20mm scale

70mm, 2³/₄"

400-583-009

**JAMESON**

Caliper with locking screw, graduated,

0 - 80 mm

95mm, 3³/₄"

400-421-000

**THORPE**

Caliper with locking screw, graduated,

0 - 80 mm

95mm, 3³/₄"

400-420-100

**NOLST TRENITÉ**

Glabella Rasp, 8mm wide

185mm, 7¹/₄"

420-700-400

**NOLST TRENITÉ**

Nasal Rasp, double-ended, 200mm, 8"

medium

420-700-501

medium/fine

420-700-502

**NOLST TRENITÉ**Micro Skin Hook, 155mm, 6¹/₈"

1 prong

420-700-001

2 prongs

420-700-002

**NOLST TRENITÉ**

Micro Skin Hook, 2 prongs, 10mm wide

420-700-210

**NOLST TRENITÉ**

Nasal Retractor, Aufrecht type

160mm, 6¹/₄"

420-700-200

**BLAKESLEY (NOLST TRENITÉ)**

Nasal Forceps, delicate, 3.5mm

85mm working length 420-700-700

**NOLST TRENITÉ**Micro Osteotome, 185mm, 7^{1/4}"

2.0mm 420-700-020

2.5mm 420-700-025

3.0mm 420-700-030

4.0mm 420-700-040

6.0mm 420-700-060

**NOLST TRENITÉ**Micro Osteotome with guard, 185mm, 7^{1/4}"

2.2mm 420-700-022

3.0mm 420-700-023

4.0mm 420-700-024

**NOLST TRENITÉ**Micro Osteotome, 185mm, 7^{1/4}"

10mm 420-700-100

12mm 420-700-120

14mm 420-700-140

16mm 420-700-160

18mm 420-700-180

**NOLST TRENITÉ**

Rhinoplasty Scissors, sharp, 100mm, 4"

straight 420-700-610

curved 420-700-611

**NOLST TRENITÉ**

Dissecting Scissors, Kilner type

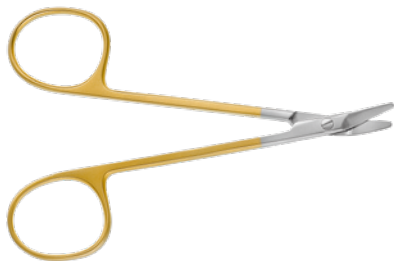
140mm, 5^{1/2}" 420-700-340**NOLST TRENITÉ**

Angled Scissors, Walter type

100mm, 4" 420-700-620

**NOLST TRENITÉ**

Halsey type

130mm, 5^{1/8}" 420-700-330

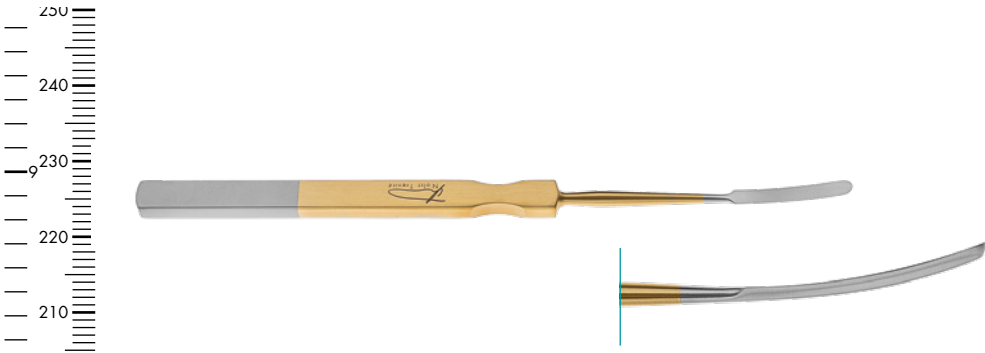

NOLST TRENITÉ
 Periosteal Elevator, Joseph Type, 3mm
 180mm, 7" 420-700-430

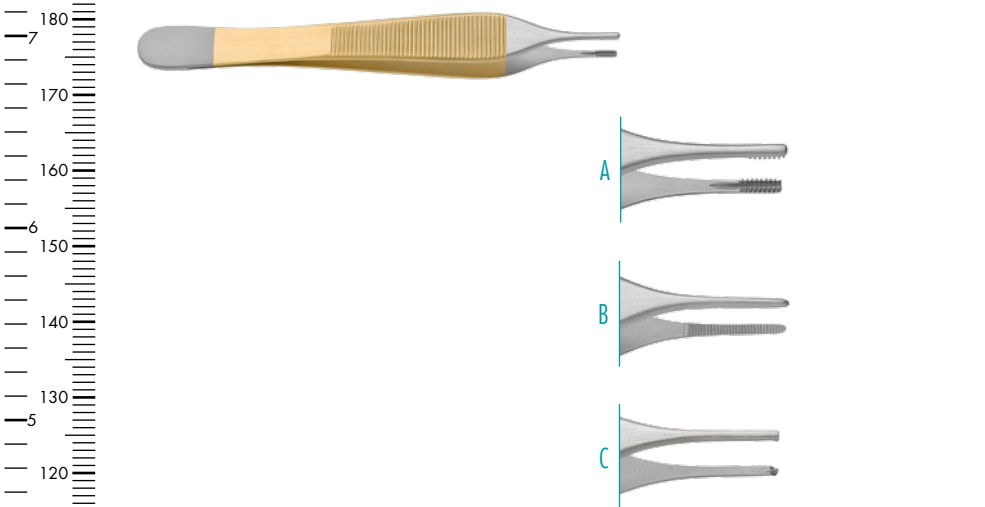

NOLST TRENITÉ
 Dressing/Tissue Forceps, 120mm, 4^{3/4}"

A Adson-Brown type	420-700-630
B Adson type	420-700-640
C Adson type	420-700-650

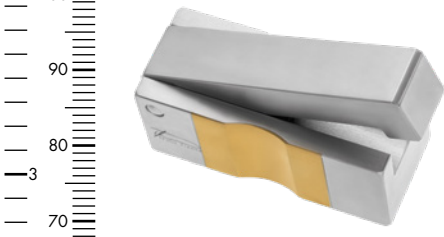

NOLST TRENITÉ
 Cartilage Crusher, Cottle type
420-700-777



NOLST TRENITÉ
 Mallet, Cottle type
420-700-888

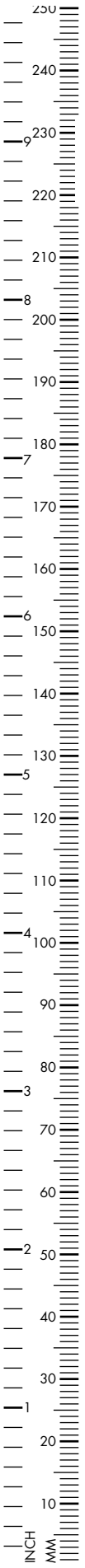



Bipolar electrode with flat plug,
105mm working length

A	700-420-002
B	700-420-001



Bipolar Suction Forceps, bayonet shaped,
200mm, 8"

1.4mm tip	700-600-201
2.0mm tip	700-600-202
230mm, 9"	
1.4mm tip	700-600-231
2.0mm tip	700-600-232
60° curved 210mm, 8 ¹ / ₄ "	
3.2mm tip	700-600-214
45° curved 210mm, 8 ¹ / ₄ "	
3.0mm tip	700-600-213



Bipolar Forceps, angled jaws, 2.0mm tip
180mm, 7"

	700-600-195
--	-------------



Bipolar Forceps, knee angled, pointed tip

165mm, 6 ¹ / ₂ "	700-600-160
220mm, 8 ² / ₃ "	700-600-220
0.5mm tip	
165mm, 6 ¹ / ₂ "	700-600-165
220mm, 8 ² / ₃ "	700-600-225
1.0mm tip	
165mm, 6 ¹ / ₂ "	700-600-161
220mm, 8 ² / ₃ "	700-600-221

NON-STICK FORCEPS

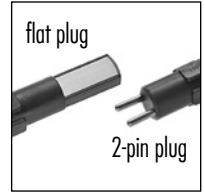

Straight		150mm		180mm		200mm	220mm
		straight tip	angled tip	straight tip	angled tip	straight tip	straight tip
0.3mm tip (point)	flat plug	700-610-150	700-611-150	700-610-180	700-611-180	700-610-200	700-610-220
	2-pin	700-612-150	700-613-150	700-612-180	700-613-180	700-612-200	700-620-220
0.6mm tip (blunt)	flat plug	700-620-150	700-621-150	700-620-180	700-621-180	700-620-200	700-620-220
	2-pin	700-622-150	700-623-150	700-622-180	700-623-180	700-622-200	700-622-220
1.0mm tip (blunt)	flat plug	700-630-150	700-631-150	700-630-180	700-631-180	700-630-200	700-630-220
	2-pin	700-632-150	700-633-150	700-632-180	700-633-180	700-632-200	700-632-220
2.0mm tip (blunt)	flat plug	700-640-150	700-641-150	700-640-180	700-641-180	700-640-200	700-640-220
	2-pin	700-642-150	700-643-150	700-642-180	700-643-180	700-642-200	700-642-220



JEWELER TYPE		110mm	
		straight tip	angled tip
0.25mm tip (point)	flat plug	700-601-710	700-601-730
	2-pin	700-601-711	700-601-731
0.6mm tip (blunt)	flat plug	700-601-712	700-601-732
	2-pin	700-601-713	700-601-733
1.0mm tip (blunt)	flat plug	700-601-714	700-601-734
	2-pin	700-601-715	700-601-735



straight tip

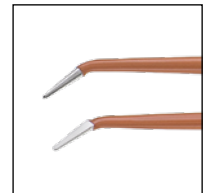

angled tip

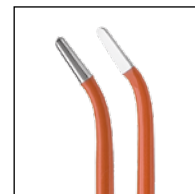

angled down tip

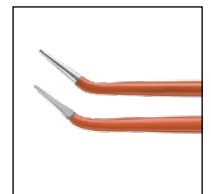

angled up tip

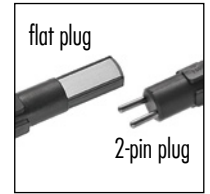

Bayonet Shape		180mm straight tip	200mm straight tip	220mm straight tip	240mm straight tip
0.3mm tip (point)	flat plug	700-650-180	700-650-200	700-650-220	700-650-240
	2-pin	700-652-180	700-652-200	700-652-220	700-652-240
0.6mm tip (blunt)	flat plug	700-660-180	700-660-200	700-660-220	700-660-240
	2-pin	700-662-180	700-662-200	700-662-220	700-662-240
1.0mm tip (blunt)	flat plug	700-670-180	700-670-200	700-670-220	700-670-240
	2-pin	700-672-180	700-672-200	700-672-220	700-672-240
2.0mm tip (blunt)	flat plug	700-680-180	700-680-200	700-680-220	700-680-240
	2-pin	700-682-180	700-682-200	700-682-220	700-682-240

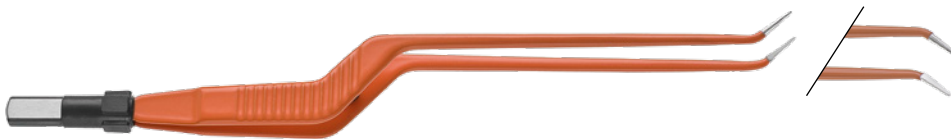

Bayonet Shape, angled up/angled down		200mm angled up tip	220mm angled up tip	200mm angled down tip	220mm angled down tip
1.0mm tip (blunt)	flat plug	700-670-201	700-670-221	700-670-203	700-670-223
	2-pin	700-672-201	700-672-221	700-672-203	700-672-223

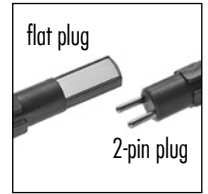

NON-STICK FORCEPS, ROUND HANDLE



Straight		150mm		180mm	
		straight tip	angled tip	straight tip	angled tip
0.3mm tip (point)	flat plug	700-010-150	700-011-150	700-010-180	700-011-180
	2-pin	700-012-150	700-013-150	700-012-180	700-013-180
0.6mm tip (blunt)	flat plug	700-020-150	700-021-150	700-020-180	700-021-180
	2-pin	700-022-150	700-023-150	700-022-180	700-023-180
1.0mm tip (blunt)	flat plug	700-030-150	700-031-150	700-030-180	700-031-180
	2-pin	700-032-150	700-033-150	700-032-180	700-033-180
2.0mm tip (blunt)	flat plug	700-040-150	700-041-150	700-040-180	700-041-180
	2-pin	700-042-150	700-043-150	700-042-180	700-043-180
Straight		200mm		225mm	
		straight tip	angled tip	straight tip	angled tip
0.3mm tip (point)	flat plug	700-010-200	700-011-200	700-010-220	700-011-220
	2-pin	700-012-200	700-013-200	700-012-220	700-013-220
0.6mm tip (blunt)	flat plug	700-020-200	700-021-200	700-020-220	700-021-220
	2-pin	700-022-200	700-023-200	700-022-220	700-023-220
1.0mm tip (blunt)	flat plug	700-030-200	700-031-200	700-030-220	700-031-220
	2-pin	700-032-200	700-033-200	700-032-220	700-033-220
2.0mm tip (blunt)	flat plug	700-040-200	700-041-200	700-040-220	700-041-220
	2-pin	700-042-200	700-043-200	700-042-220	700-043-220



straight tip

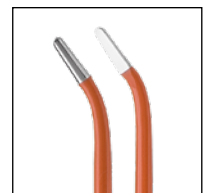

angled down tip

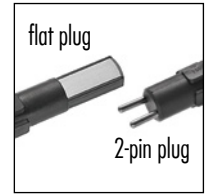

Bayonet		180mm straight tip	200mm straight tip
0.3mm tip (point)	flat plug	700-050-180	700-050-200
	2-pin	700-052-180	700-052-200
0.6mm tip (blunt)	flat plug	700-060-180	700-060-200
	2-pin	700-062-180	700-062-200
1.0mm tip (blunt)	flat plug	700-070-180	700-072-200
	2-pin	700-072-180	700-072-200
2.0mm tip (blunt)	flat plug	700-080-180	700-082-200
	2-pin	700-082-180	700-082-200
Bayonet		225mm straight tip	250mm straight tip
0.3mm tip (point)	flat plug	700-050-220	700-050-250
	2-pin	700-052-220	700-052-250
0.6mm tip (blunt)	flat plug	700-060-220	700-060-250
	2-pin	700-062-220	700-062-250
1.0mm tip (blunt)	flat plug	700-070-220	700-070-250
	2-pin	700-072-220	700-072-250
2.0mm tip (blunt)	flat plug	700-080-220	700-080-250
	2-pin	700-082-220	700-082-250



straight tip

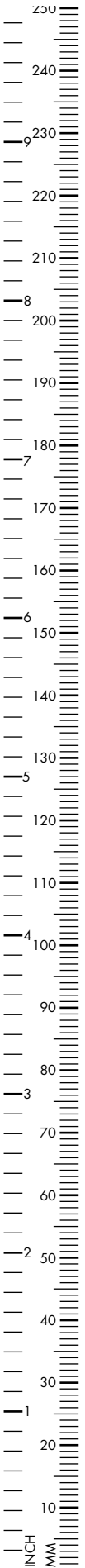

SINUSCOPY

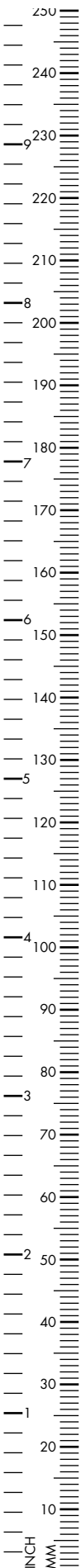

**LICHTWITZ-BIER**

Antrum Trocar Needle, 100mm, 4"

Ø 1.5mm	252-015-110
Ø 1.8mm	252-018-110
Ø 2.0mm	252-020-110

**EICKEN**Antrum Trocar Needle, 105mm, 4¹/₈"

Ø 1.5mm	252-115-110
Ø 1.8mm	252-118-110
Ø 2.0mm	252-120-110
Ø 2.5mm	252-125-110

**LICHTWITZ**

Antrum Trocar, 85mm working length

Ø 1.8mm	165-052-018
---------	-------------

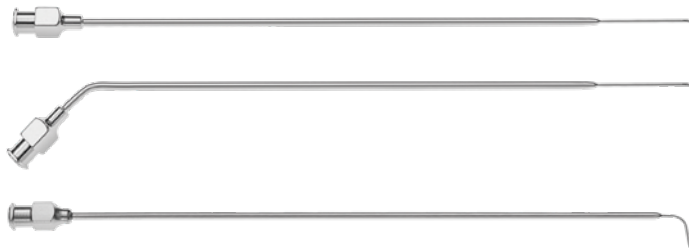
Septum Needle, with LuerLock attachment,
Ø 0.8mm

straight	252-005-170
angled	252-003-170
angled tip	252-004-170

**BABY-EICKEN**Antrum Cannula, 90mm, 3¹/₂"

1.2mm	252-009-012
1.5mm	252-009-015
2.0mm	252-009-020

**EICKEN**Antrum Cannula, slightly curved,
130mm, 5¹/₈"

Ø 2.5mm	252-025-150
Ø 3.0mm	252-025-151
Ø 4.0mm	252-025-152

**EICKEN**Antrum Cannula with central opening, curved,
140mm, 5¹/₂"

Ø 2.5mm	252-125-150
Ø 3.0mm	252-125-151
Ø 4.0mm	252-125-152

**EICKEN**Antrum Cannula, cut-off-hole, 150mm, 6"
strongly curved

Ø 2.5mm	252-225-150
Ø 3.0mm	252-225-151
Ø 4.0mm	252-225-152

slightly curved

Ø 2.5mm	252-325-150
Ø 3.0mm	252-325-151
Ø 4.0mm	252-325-152

slightly curved, malleable

Ø 2.5mm	252-425-150
Ø 3.0mm	252-425-151
Ø 4.0mm	252-425-152

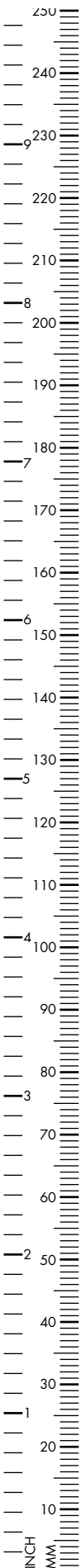
**EICKEN**

Sinus Suction Tube with cut-off hole,
145mm, 5³/₄"

Ø 2.5mm	252-725-150
Ø 3.0mm	252-725-151
Ø 4.0mm	252-725-152

**PASQUINI**

Sinus Suction Tube with olive tip

Ø 2.5mm	252-825-150
Ø 3.0mm	252-825-151
Ø 4.0mm	252-825-152



Suction Tube straight, mit olive Ø 2.5mm,
without cut off hole, malleable

150mm, 6"	252-525-155
-----------	-------------

**FERGUSON**

Suction Tube, 180mm, 7"

Ø 1.6mm, 5 Charr.	165-525-005
Ø 2.0mm, 6 Charr.	165-525-006
Ø 2.3mm, 7 Charr.	165-525-007
Ø 2.5mm, 8 Charr.	165-525-008
Ø 3.0mm, 9 Charr.	165-525-009
Ø 3.3mm, 10 Charr.	165-525-010
Ø 3.6mm, 11 Charr.	165-525-011
Ø 4.0mm, 12 Charr.	165-525-012
Ø 5.0mm, 15 Charr.	165-525-015

**FAZIER**

30° angled, with button tip, 100mm, 4"

6 Charr.	165-523-306
8 Charr.	165-523-308
10 Charr.	165-523-310
12 Charr.	165-523-312
15 Charr.	165-523-315

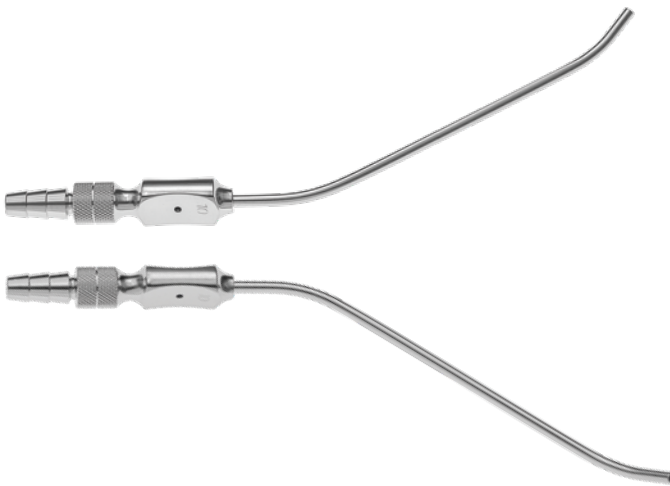
**FRAZIER**

10 Charr., 100mm, 4"

left curved	165-523-401
right curved	165-523-402

**KAHN-FRAZIER**10 Charr., s-shaped,
150mm / 6" working length

Fig. 1 slightly curved	165-523-511
Fig. 2 strongly curved	165-523-512



FISCH

Suction/Irrigation Tube, 2.5 x 2.0mm

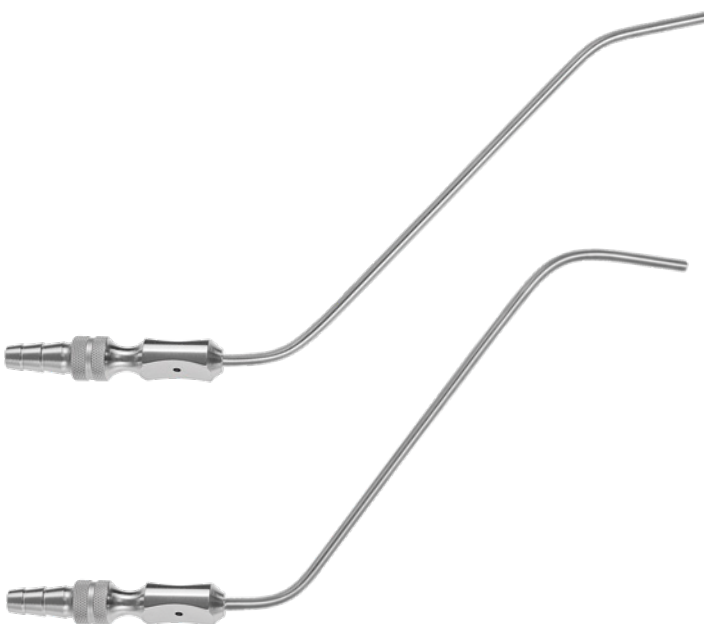
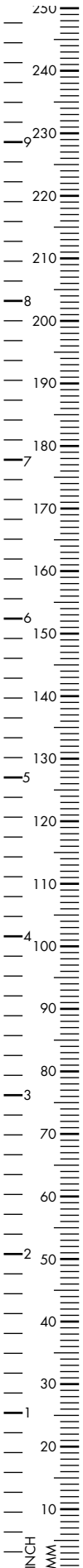
180mm, 7" 252-025-180



SIEBENMANN

Irrigation Antrum Cannula, blunt, Ø 2.5mm

130mm, 5 1/8"

inside opening 165-071-025

outside opening 165-072-025



RITTER

Frontal Sinus Bougie, 160mm, 6 1/4"

Ø 2.5 mm 252-043-025

Ø 3.0 mm 252-043-030

Ø 4.0 mm 252-043-040

Ø 5.0 mm 252-043-050



Antrum Trephine, american pattern

180mm, 7"

sharp 252-050-180

blunt 252-052-180

**MUELLER**

Antrum Rasp, diamond dusted tip,
205mm, 8^{1/8}"

fine

3mm	252-051-003
-----	-------------

4mm	252-051-004
-----	-------------

coarse

3mm	252-053-003
-----	-------------

4mm	252-053-004
-----	-------------

**PLESTER**

Sickle knife, slightly curved blade

160mm, 6 ^{1/4} "	410-101-160
---------------------------	-------------



Sickle knife, sharp, 200mm, 8"

sharp	252-205-190
-------	-------------

blunt	252-215-190
-------	-------------

**HALLE**Antrum Curette, malleable, 210mm, 8^{1/4}"

Fig. 1 252-081-210

Fig. 2 252-082-210

Fig. 3 252-083-210

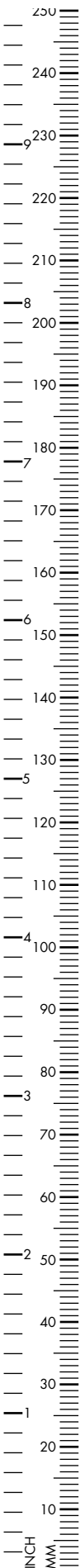

Antrum Spoon, oval, 200mm, 8"

Fig. 1, 7mm 252-071-190

Fig. 2, 8mm 252-082-190

Fig. 3, 9mm 252-093-190



Antrum Spoon, 200mm, 8"

round, 45° curved 252-171-190

oval, small, curved 252-182-190

oval, large, 30° angled 252-193-190

**PRATT**

Ethmoid Curette, double-ended

190mm, 7^{1/2}" 252-008-190

**KUHN-BOLGER**Antrum Spoon, 190mm, 7^{1/2}"

55° curved 252-172-190

90° curved 252-173-190

**UFFENDORDE**Bone Curette, 170mm, 6^{2/3}"

45° angled right 210-345-007

45° angled left 210-347-007

**FAULKNER**

Antrum Curette

220mm, 8^{2/3}" 252-071-220**FAULKNER**Antrum Curette, malleable, 220mm, 8^{2/3}"

5 x 9mm ring 252-071-222

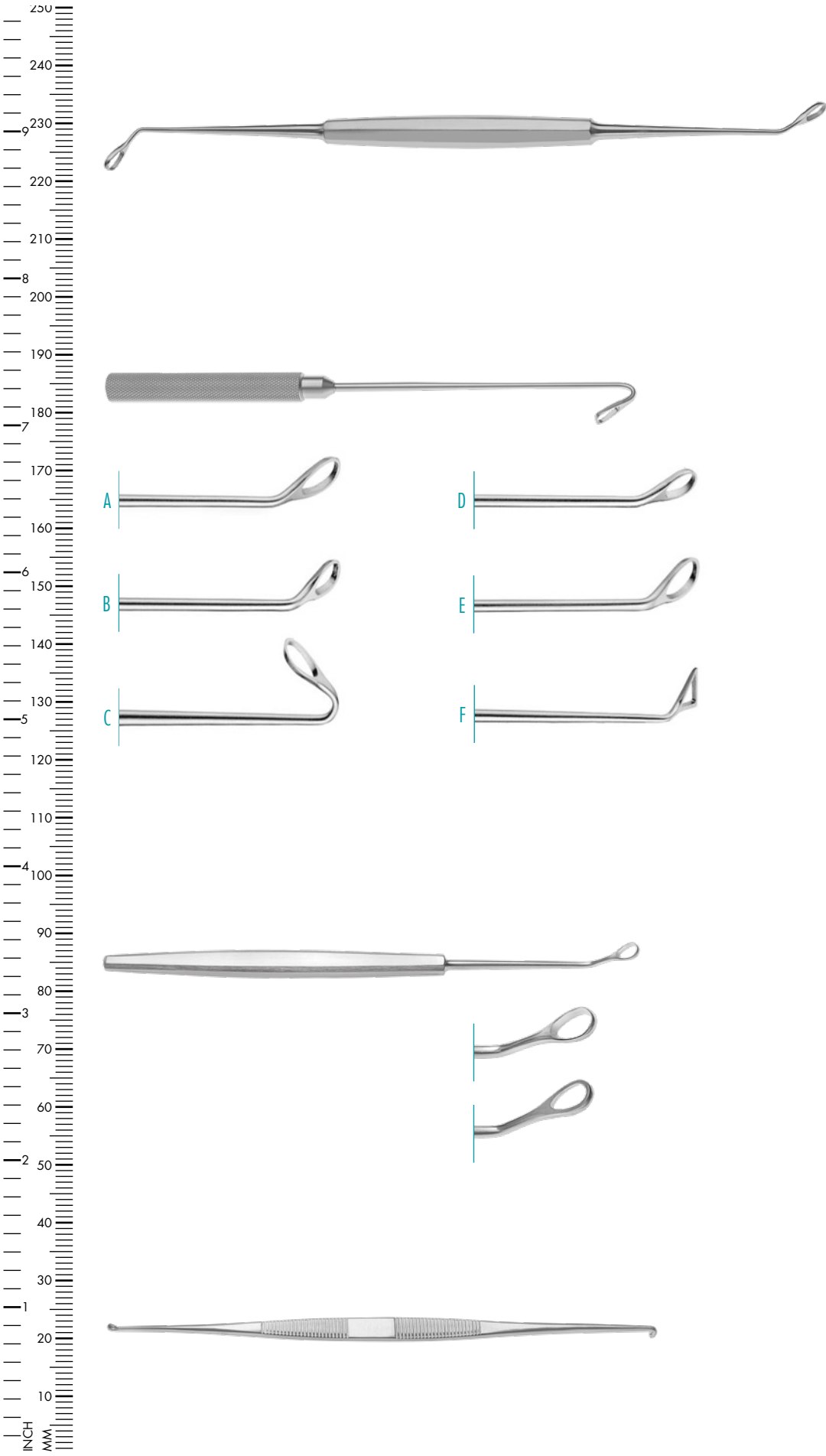

HALLE

Antrum Curette

245mm, 9²/₃"

252-072-063

COAKLEY

Antrum Curette, rigid shank, 170mm, 6²/₃"

- A Fig. 1 252-072-001
- B Fig. 2 252-072-002
- C Fig. 3 252-072-003
- D Fig. 4 252-072-004
- E Fig. 5 252-072-005
- F Fig. 6 252-072-006

COAKLEY

Antrum Curette, small size, 200mm, 8"

forward cutting 252-113-190

backward cutting 252-114-190

Curette, double-ended, oval, short curve 45°, semi-sharp, 2.2mm
other side: 90° long curve, 2.7mm

190mm, 7¹/₂" 252-027-190

**RIBBON**

Retractor, malleable

200 x 6mm	170-973-006
200 x 12mm	170-973-012
200 x 17mm	170-973-017
200 x 20mm	170-973-020
250 x 25mm	170-973-025

**TUFFIER**

Retractor, malleable

200 x 25mm	170-975-250
------------	-------------



Orbital Protector

235mm, 9 ¹ / ₄ "	252-042-235
--	-------------



Antrum Punch, 3.5 x 3.7mm bite,
110mm / 4¹/₃" working length

65° forward biting	252-150-110
30° upwards cutting	252-151-110



HAJEK-KOFLER

Sphenoid Punch, 3.5 x 3.7mm, 360° rotating

170mm, 6 ² / ₃ "	252-535-170
--	-------------



MCKENTY

Sphenoid Punch, rotating, through cutting,
1.8 x 2.0mm

120mm, 4 ³ / ₄ "	252-147-120
--	-------------

1.6 x 2.0mm

170mm, 6 ² / ₃ "	252-146-170
--	-------------

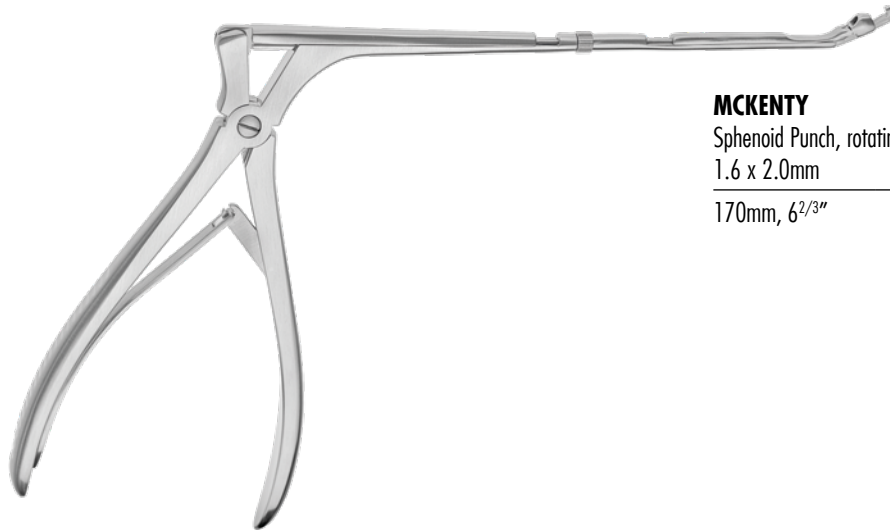
**MCKENTY**

Sphenoid Punch, rotating, upwards cutting,
1.6 x 2.0mm

170mm, 6²/₃" 252-151-170

**CITELLI**

Bone punch, 1.5 mm, through cutting

170mm, 6²/₃" 252-147-170

**BEYER**

Bone punch, 2.0 mm, through cutting

170mm, 6²/₃" 252-148-170

**HAJEK-KOFLER**

Bone Nibbler, 3.5 x 3.5mm,
140mm, 5¹/₂"

upbiting 252-145-001

downbiting 252-145-002

upbiting, backward 252-145-003

downbiting, backward 252-145-004

upbiting, forward 252-145-005

upbiting, 4.5 x 4.5mm 252-146-001



KERRISON
Punch, regular handle, superflat footplate



180mm, 7"
40° upwards cutting

1mm	250-400-181SF
1.5mm	250-400-189SF
2mm	250-400-182SF
3mm	250-400-183SF
4mm	250-400-184SF
5mm	250-400-185SF



180mm, 7"
40° downwards cutting

1mm	250-420-181SF
1.5mm	250-420-189SF
2mm	250-420-182SF
3mm	250-420-183SF
4mm	250-420-184SF
5mm	250-420-185SF

180mm, 7"
90° upwards cutting

1mm	250-411-181SF
2mm	250-411-182SF
3mm	250-411-183SF
4mm	250-411-184SF
5mm	250-411-185SF

180mm, 7"
90° downwards cutting

1mm	250-430-181SF
2mm	250-430-182SF
3mm	250-430-183SF
4mm	250-430-184SF
5mm	250-430-185SF

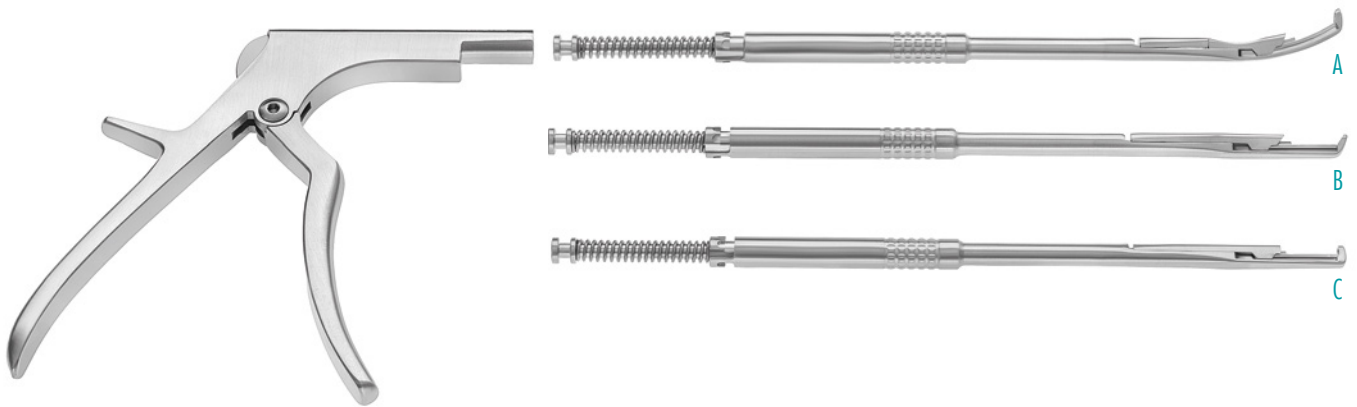

Handle only

250-245-000

A 360° Foraminotomy Punch
exchangeable shaft, ejector, thin footplate
40° angled

180mm, 7"		200mm, 8"	
2mm	250-280-182	2mm	250-280-202
3mm	250-280-183	3mm	250-280-203
4mm	250-280-184	4mm	250-280-204
5mm	250-280-185	5mm	250-280-205

B 360° Laminectomy Punch
exchangeable shaft, ejector, thin footplate
40° angled

180mm, 7"		200mm, 8"	
1mm	250-210-181	1mm	250-210-201
1.5mm	250-210-180	1.5mm	250-210-200
2mm	250-210-182	2mm	250-210-202
3mm	250-210-183	3mm	250-210-203
4mm	250-210-183	4mm	250-210-204
5mm	250-210-185	5mm	250-210-205

C 360° Laminectomy Punch
exchangeable shaft, ejector, thin footplate
90° angled

180mm, 7"		200mm, 8"	
1mm	250-245-181	1mm	250-245-201
1.5mm	250-245-180	1.5mm	250-245-200
2mm	250-245-182	2mm	250-245-202
3mm	250-245-183	3mm	250-245-203
4mm	250-245-184	4mm	250-245-204
5mm	250-245-185	5mm	250-245-205

All instruments are available with CERACUT® coating. Code number + CC (e.g. 250-400-181CC)



Frontal Sinus Punch Forceps, 40° upbiting forward, 2mm, 70° upturned shaft, 140mm, 5 1/2"

2mm bite	252-499-175
3mm bite	252-500-175



Frontal Ostium nasal forceps, 140mm, 5 1/2"

3x3mm, 5mm	252-499-140
2x2mm, 5mm	252-500-140
5x5mm, 5mm	252-501-140

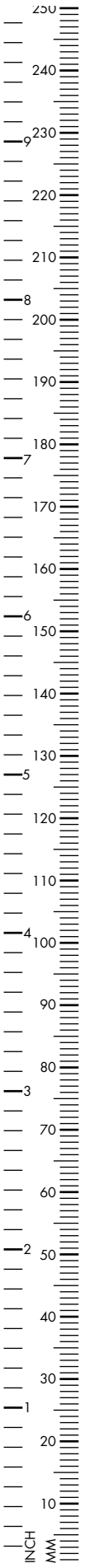



Sinuscope, autoclavable, Ø 4mm,
180mm, 7"

● 0°	252-104-000
● 30°	252-104-030
● 45°	252-104-045
● 70°	252-104-070



Sinuscope, autoclavable, Ø 2.7mm,
180mm, 7"

● 0°	252-127-000
● 30°	252-127-030
● 70°	252-127-070



Sinuscope, autoclavable, Ø 2.7mm,
110mm, 4¹/₃"

● 0°	252-127-200
● 30°	252-127-230

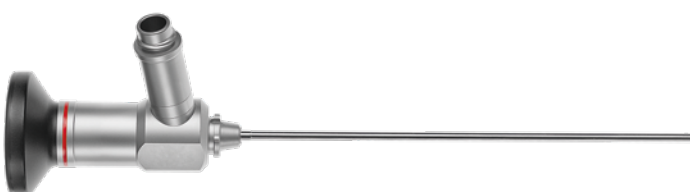

Sinuscope, Ø 3.0mm,
140mm, 5¹/₂"

0°	252-130-000
30°	252-130-030
45°	252-130-045
70°	252-130-070

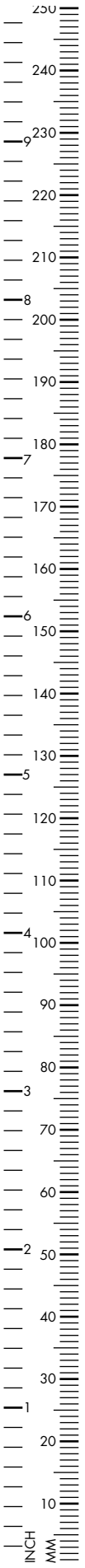

Flat Handle for Sinusscopes, 120mm, 4^{3/4}"

for Ø 4.0mm	251-104-001
for Ø 2.7mm	251-127-001



Round Handle for Sinusscopes, 120mm, 4^{3/4}"

for Ø 4.0mm	251-104-002
for Ø 2.7mm	251-127-002

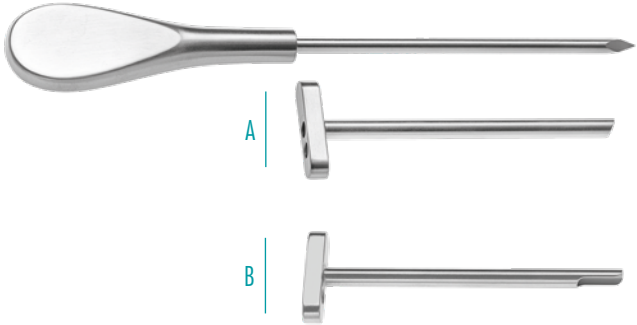

Sinuscopy Trocar and Sheath, Ø 5.2mm, 85mm working length, sharp for 4mm scopes

A oblique end	251-104-120
B duckbill tip	251-105-120

for 2.7mm scopes

A oblique end	251-127-120
---------------	-------------



Biopsy and Grasping Forceps,
3 x 6mm oval cup

90mm, 3¹/₂" 252-503-090

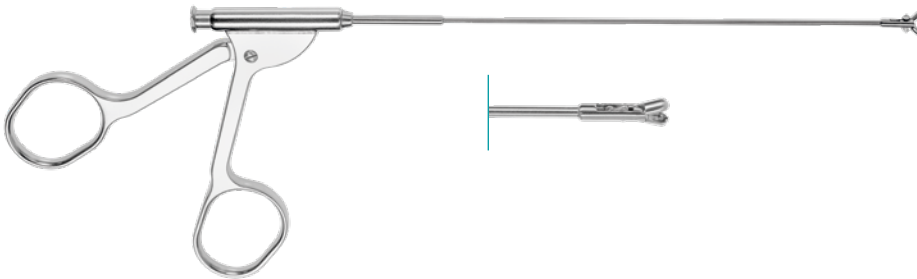

Biopsy and Grasping Forceps, delicate pattern,
3 mm oval cup

140mm, 5¹/₂" 252-503-140



Biopsy and Grasping Forceps, malleable shaft,
4mm biopsy cup, vertical opening

180mm, 7" 252-174-180

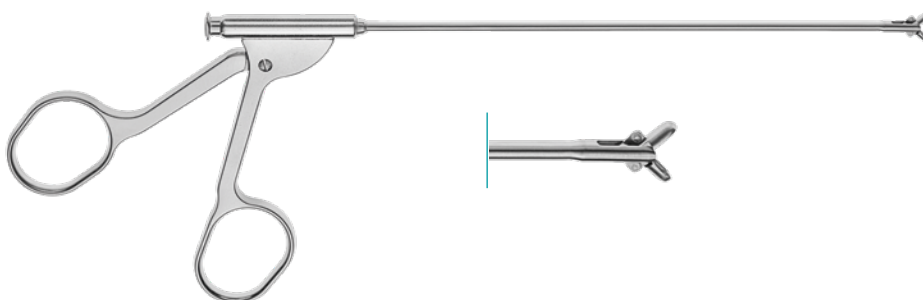

Biopsy and Grasping Forceps,
3mm round cup, straight

150mm, 6" 252-503-150

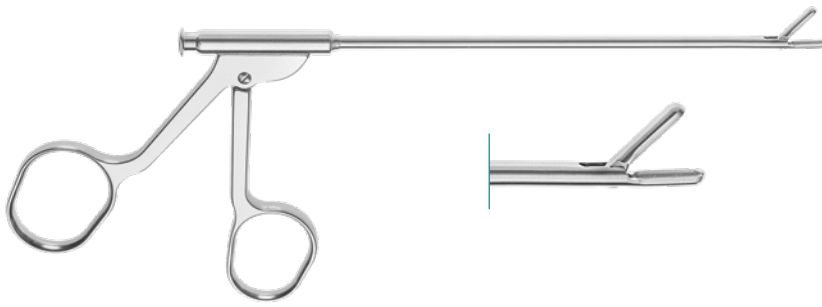
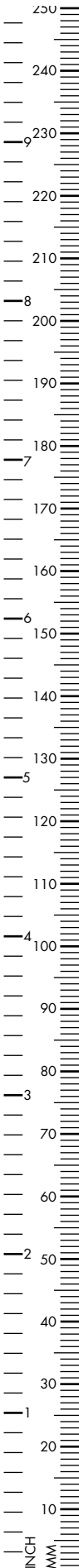

TAKAHASHI

Ethmoidal Forceps, 3 x 10mm

130mm, 5¹/₈" 252-002-130

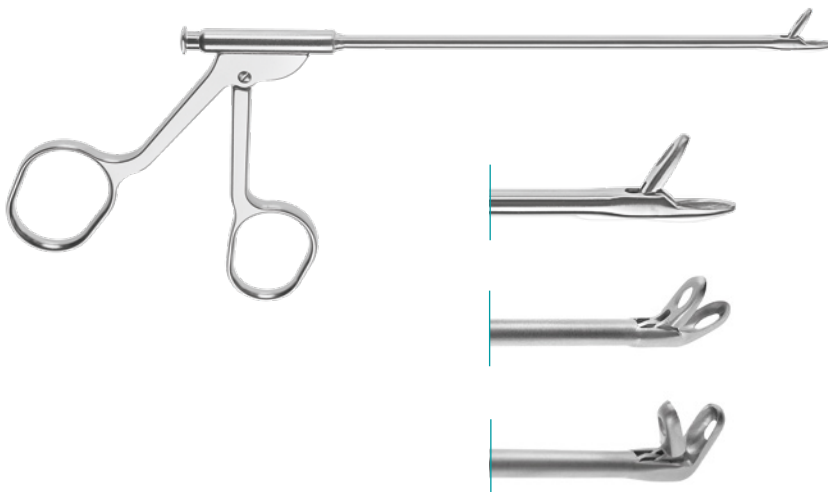

BLAKESLEY

Ethmoidal Forceps, straight, 130mm, 5¹/₈"

Size 0, 2.5mm	252-034-130
Size 1, 3.0mm	252-034-131
Size 2, 3.5mm	252-034-132
Size 3, 4.0mm	252-034-133
Size 4, 5.0mm	252-034-134
Size 5, 6.0mm	252-034-135

BLAKESLEY-WILDE

45° curved up

Size 0, 2.5mm	252-035-130
Size 1, 3.0mm	252-035-131
Size 2, 3.5mm	252-035-132
Size 3, 4.0mm	252-035-133
Size 4, 5.0mm	252-035-134
Size 5, 6.0mm	252-035-135

BLAKESLEY-WILDE

90° curved up

Size 0, 2.5mm	252-037-130
Size 1, 3.0mm	252-037-131
Size 2, 3.5mm	252-037-132
Size 3, 4.0mm	252-037-133
Size 4, 5.0mm	252-037-134
Size 5, 6.0mm	252-037-135

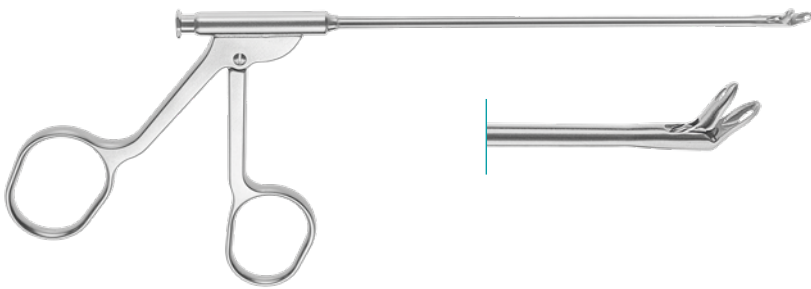
**STRUEMPEL-VOSS**

Ethmoidal Forceps, 90° curved to the right,
45° upwards, 130mm, 5¹/₈"

Size 1	252-036-131
Size 2	252-036-132

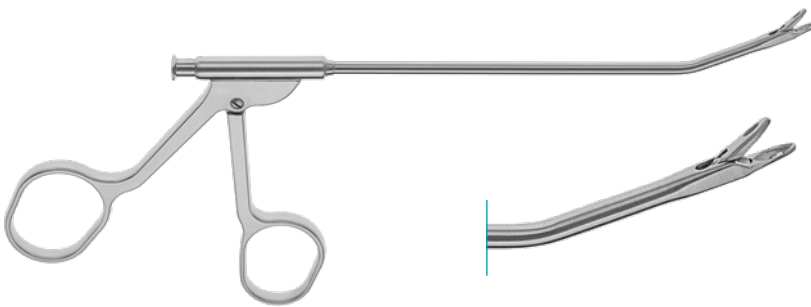
**BLAKESLEY**

Spoon Forceps, 2.7mm straight,
130mm working length

25°	252-234-130
45°	252-234-131

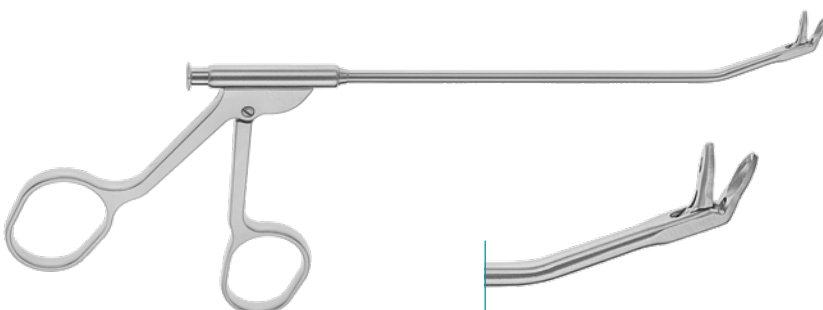
**BLAKESLEY**

Spoon Forceps, 45° curved up
130mm working length

2.7mm	252-235-130
3.0mm	252-235-131
3.5mm	252-235-132

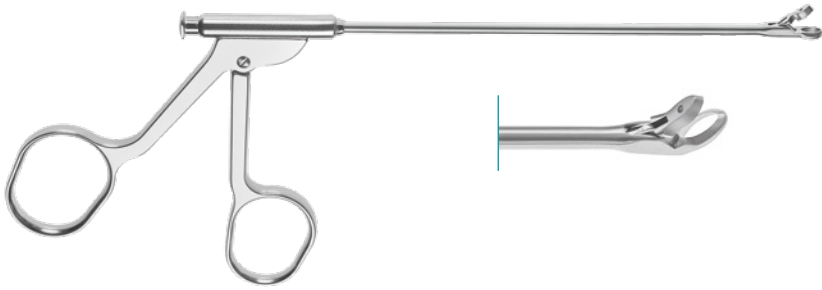
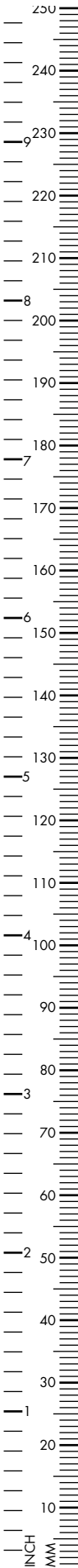

BLAKESLEY

Ethmoidal Forceps, straight, 130mm, 5¹/₈"

Fig. 0, 3.0mm 252-004-130

Fig. 1, 3.5mm 252-004-131

Fig. 2, 4.0mm 252-004-132

45° curved up

Fig. 0, 3.0mm 252-014-130

Fig. 1, 3.5mm 252-014-131

Fig. 2, 4.0mm 252-014-132

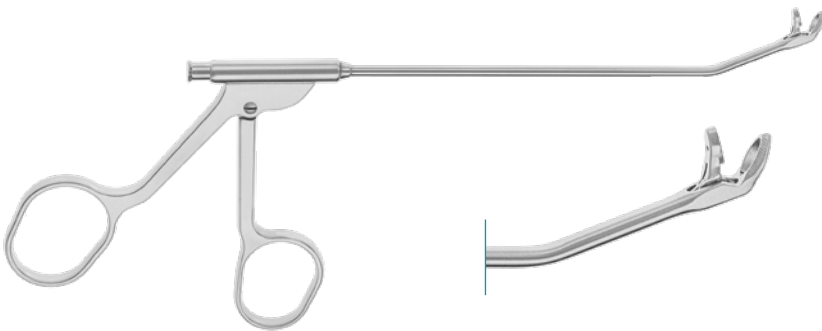

BLAKESLEY

Spoon Forceps, cutting, 2.7mm,
45° angled up, sheath 25° bent up

130mm, 5¹/₈" 252-214-130

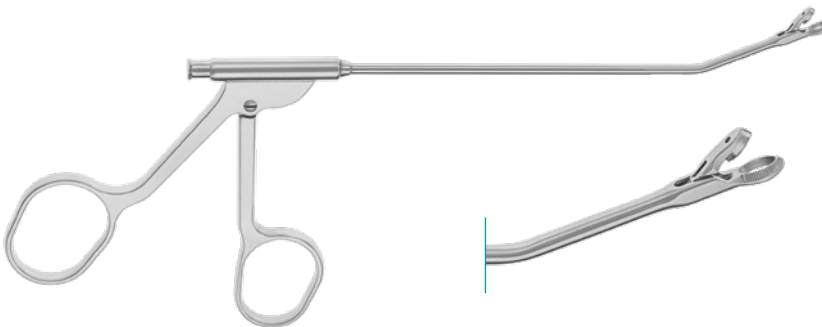

BLAKESLEY

Spoon Forceps, cutting, 2.7mm,
straight sheath, sheath 25° bent up

252-204-130

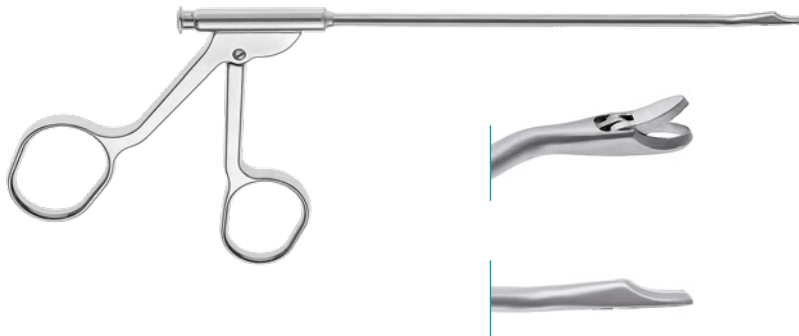
**BLAKESLEY**Ethmoidal Forceps, through-cutting,
115mm, 4¹/₂"

30° curved left	252-401-025
30° curved right	252-403-025

**DUCKBILL**Duckbill Punch, straight,
130mm, 5¹/₈" working length

Fig. 0, 2.0mm bite	252-206-000
Fig. 1, 2.5mm bite	252-206-001
Fig. 2, 3.0mm bite	252-206-002

upwards curved

Fig. 0, 2.0mm bite	252-207-000
Fig. 1, 2.5mm bite	252-207-001
Fig. 2, 3.0mm bite	252-207-002

**GRUENWALD-HENKE**Nasal Forceps, through-cutting,
130mm, 5¹/₈" working length
straight

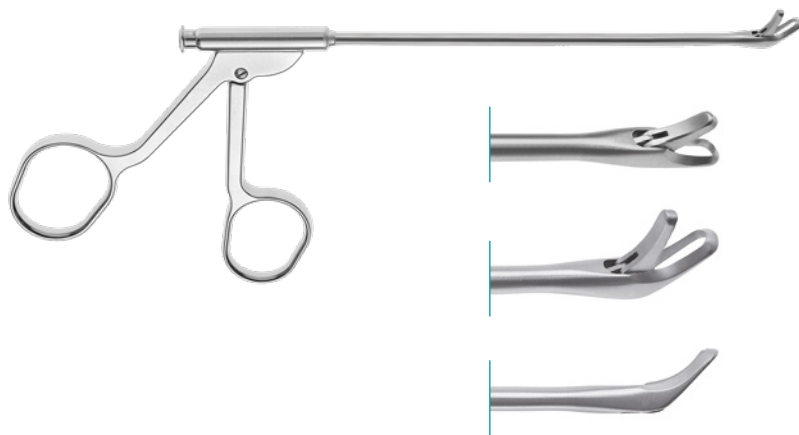
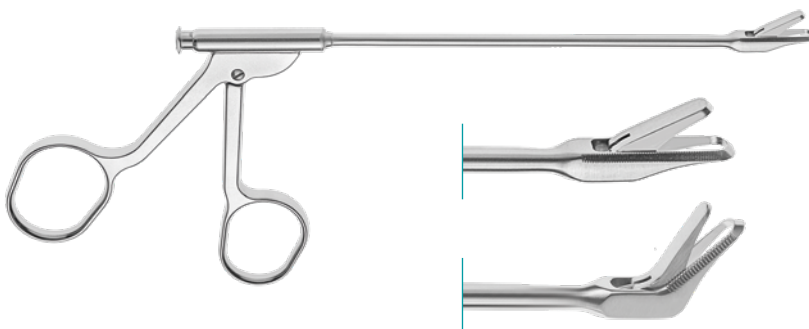
8.0 x 3.0mm	252-013-130
11.5 x 3.5mm	252-014-135

upcurved

8.0 x 3.0mm	252-013-145
11.5 x 3.5mm	252-014-145

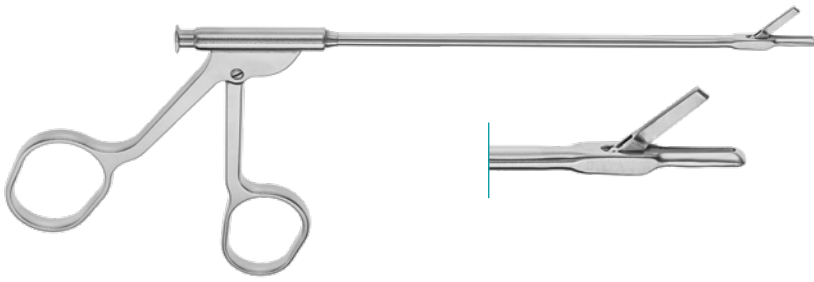
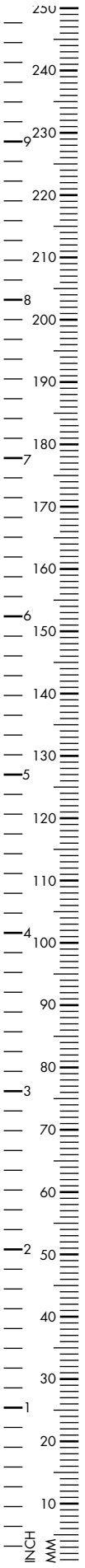

STRUYCKEN

Ethmoidal Forceps

130mm, 5¹/₈"

252-003-130

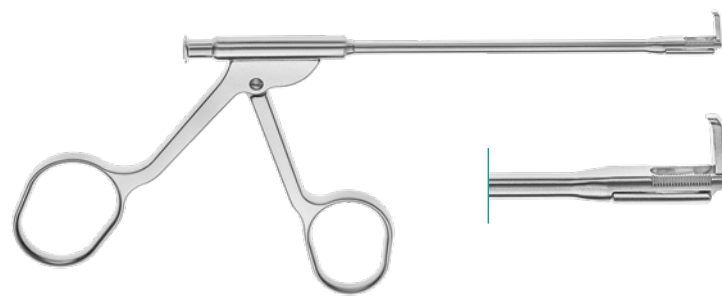

OSTROM

Antrum punch, 2.5mm bite, backwards cutting, 100mm, 4" working length

upside cutting

252-015-100

right side cutting

252-115-100

left side cutting

252-215-100

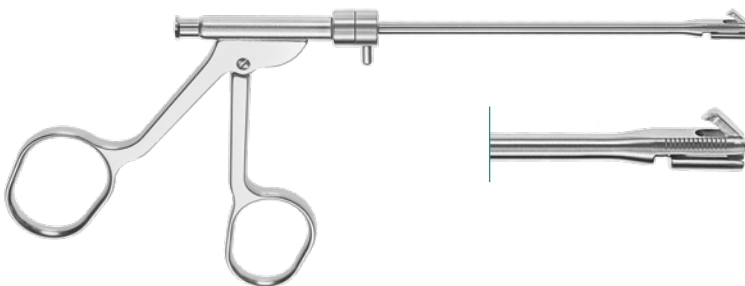

OSTROM

Antrum punch, 2.5mm bite, backwards cutting, 360° rotatable,

100mm, 4" working length

252-315-100

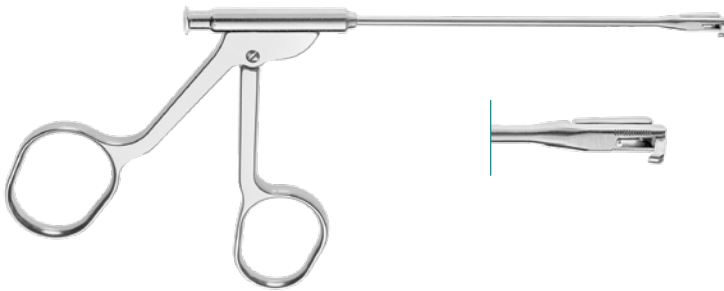
**OSTROM**

Antrum punch, 1.5mm bite, backwards cutting,
100mm, 4" working length

upside cutting	252-010-100
right side cutting	252-110-100
left side cutting	252-210-100

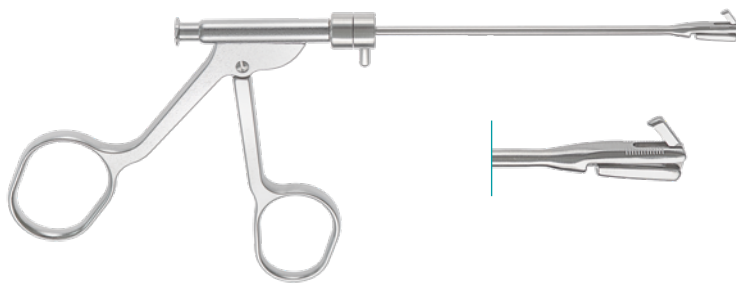
**OSTROM**

Antrum punch, 1.5mm bite, backwards cutting,
360° rotatable

100mm, 4" working length	252-310-100
-----------------------------	-------------

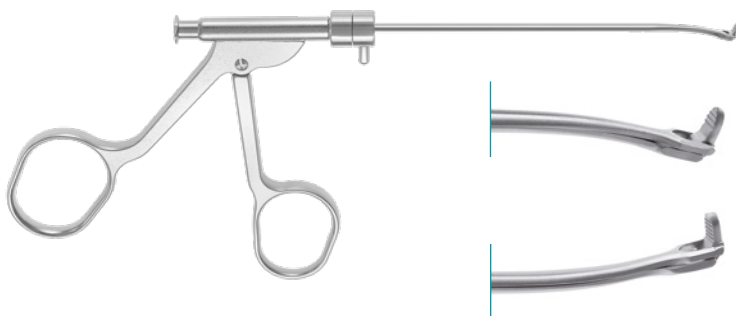
**OSTROM**

Ethmoidal Forceps, rotating, micro bite
100mm, 4"

curved down	252-315-200
curved up	252-315-300

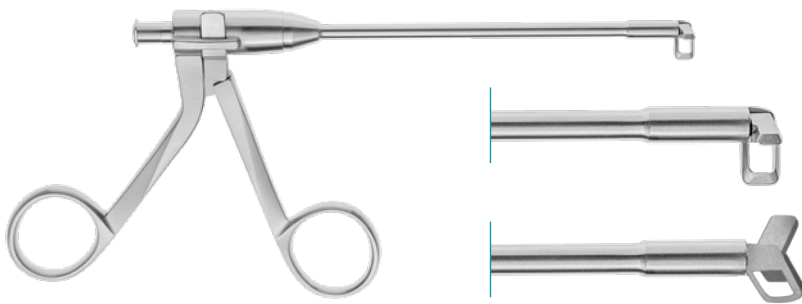
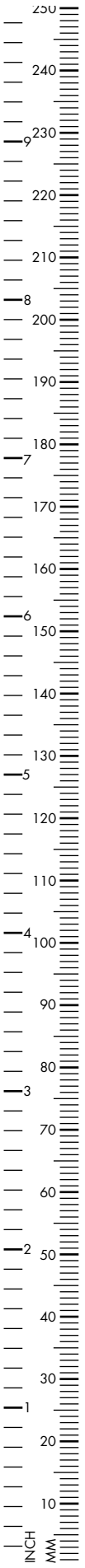

SIDECUTTER

Antrum punch, 3.5mm bite,
100mm, 4" working length

downward right cutting	252-171-100
downward left cutting	252-173-100

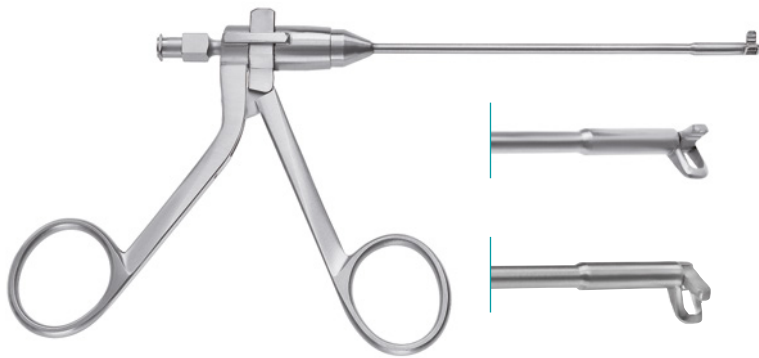

SIDECUTTER

Antrum punch, 2.5mm bite,
100mm, 4" working length

left cutting	252-173-700
right cutting	252-171-700
downward right cutting	252-171-300
downward left cutting	252-173-300

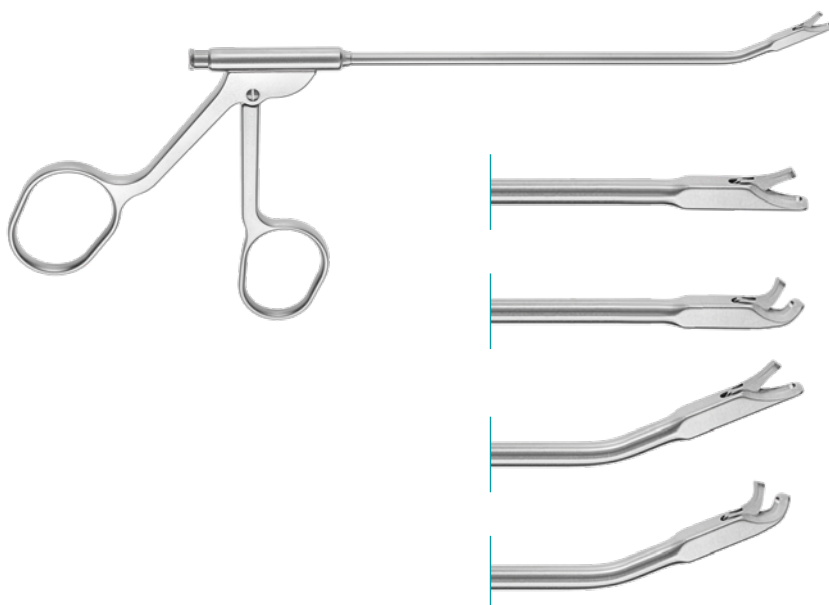

Nasal Forceps, 1.5mm, thru-cutting,
with LuerLock, 130mm, 5^{1/8}" working length

straight shaft	252-020-130
jaws 45° angled up	252-019-130
straight jaws, 30° curved up	252-017-130
30° curved up, jaws 45° angled up	252-015-130

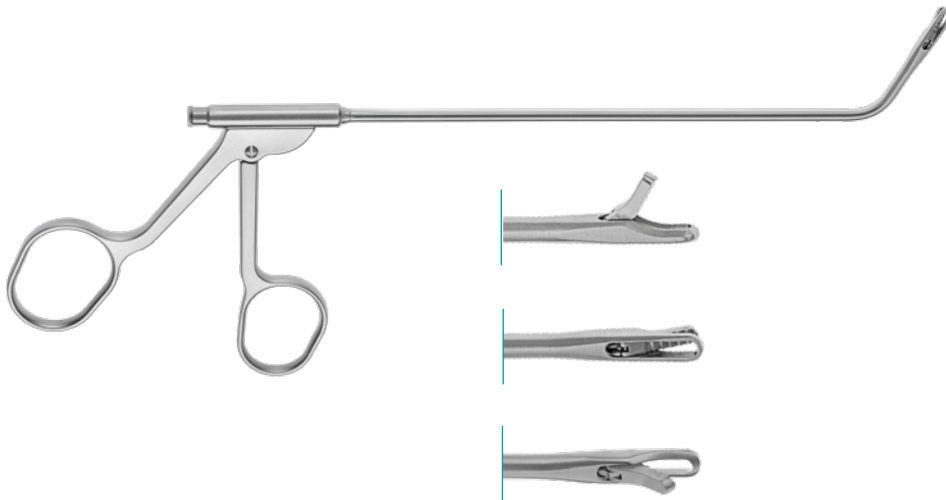

NICOLAI

Antrum Forceps, 2mm bite, 65° curved up

backward opening	252-477-141
left opening	252-477-142
right opening	252-477-143

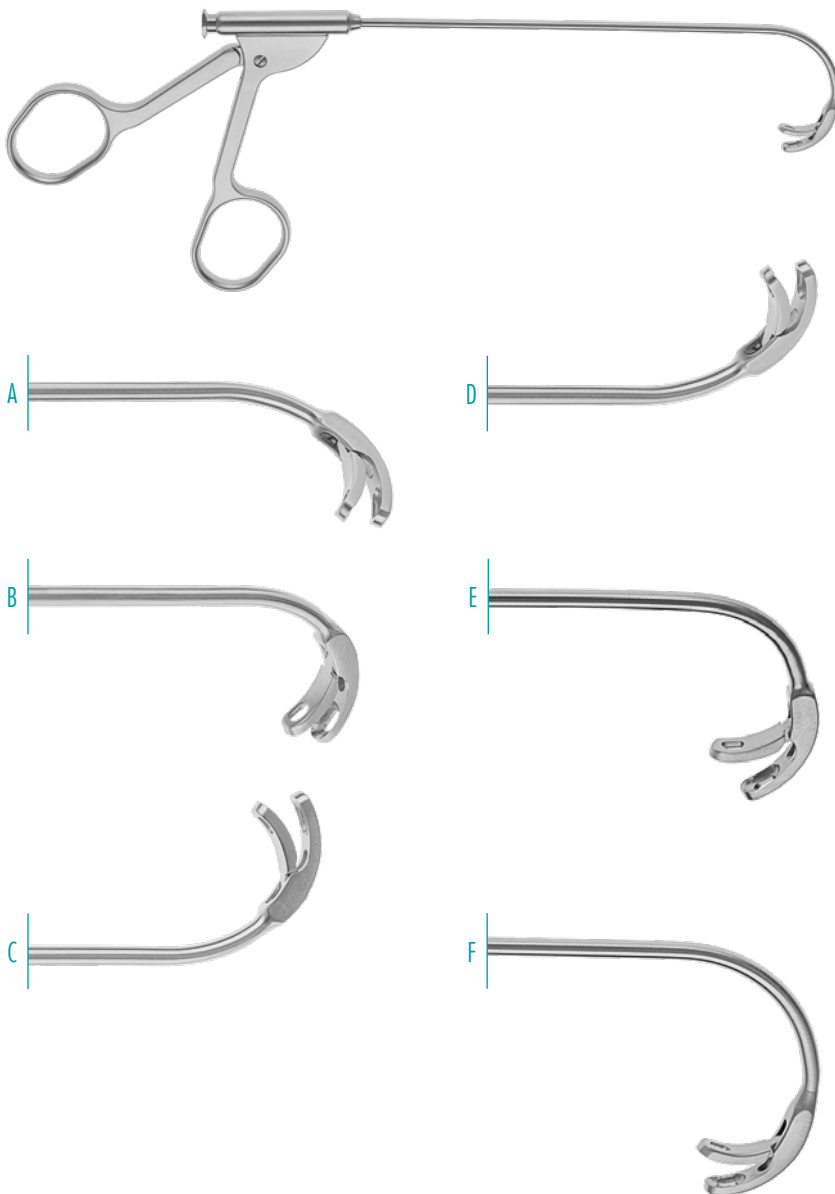

HEUWIESER

Antrum Grasping Forceps, 90° curved, 130mm, 5^{1/8}"

A 120° backward opening	252-410-112
B 120° right opening	252-410-113
C 120° left opening	252-410-111
D 120° upwards angled	252-410-110
E 115° curved, 140° backward opening	252-410-114
F 140° curved, 155° backward opening	252-410-115

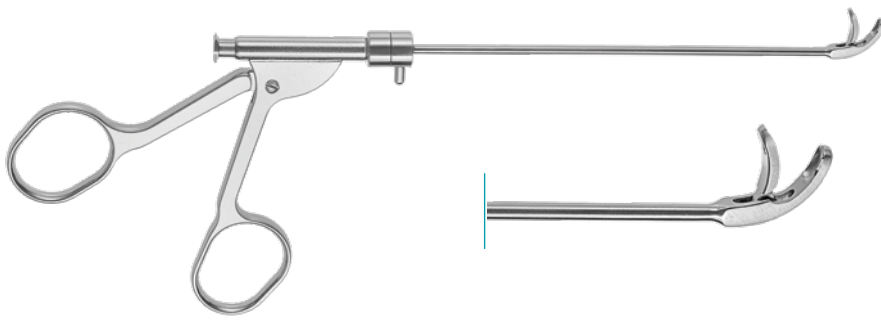
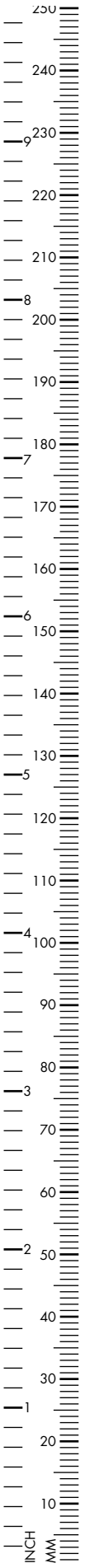

HEUWIESER

Antrum Grasping Forceps, rotating,
130mm, 5 1/8"

120° curved, 90° backward opening 252-411-112

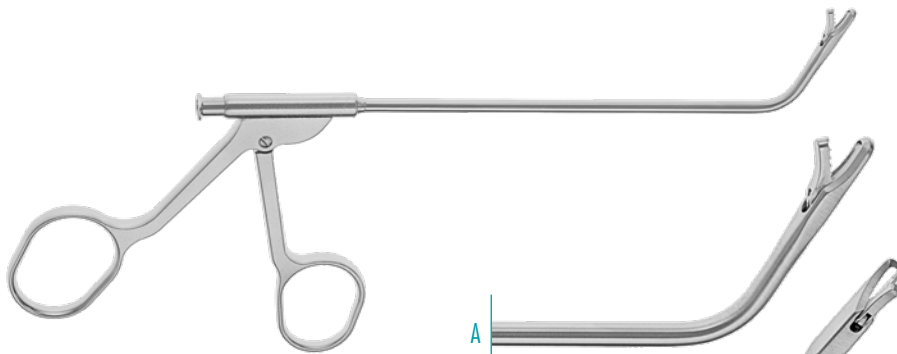

GRÜNWALD

Sinuscopy Forceps, 70° curved up,
2.0mm cut, 130mm, 5 1/8"

- A upside opening 252-600-070
- B right side cutting 252-601-070
- C left side cutting 252-602-070



KUHN

Ethmoidal Forceps, 60° curved up,
1.5mm cut, through-cutting,
120mm, 4 3/4"

- A left 252-415-121
- B right 252-415-122
- C vertical opening 252-415-120

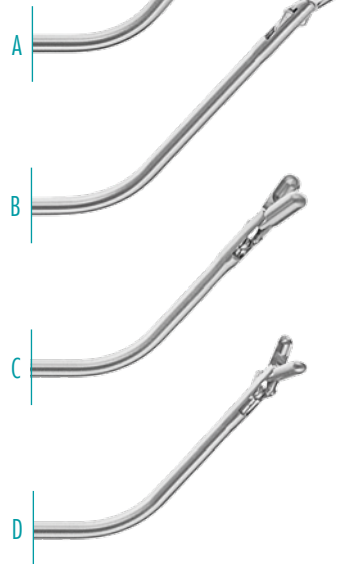
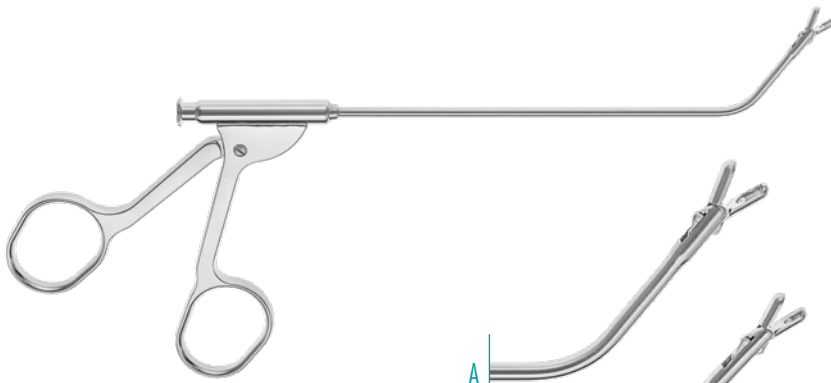
**KUHN-BOLGER**

Giraffe Forceps, 55° angled up,
130mm, 5^{1/8}"

A vertical action, 3x6 mm	252-343-120
A vertical action, 2x4 mm	252-342-120
C horizontal action, 3x6 mm	252-353-120
D horizontal action, 2x4 mm	252-352-120

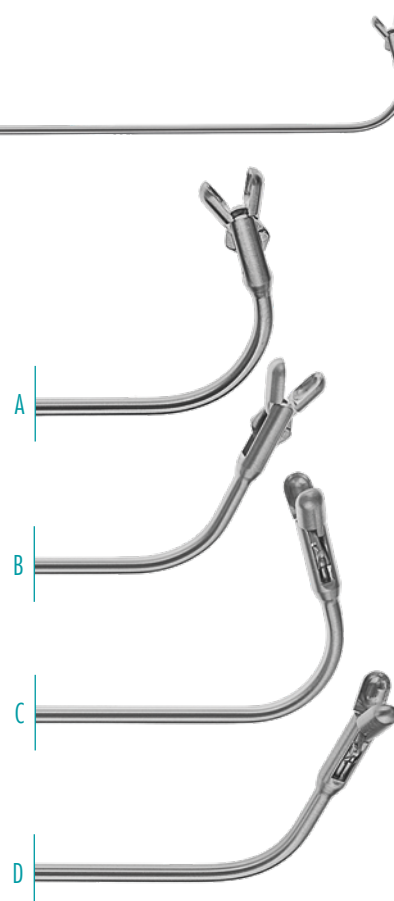
**RZ**

Giraffe Biopsy Forceps, 4x8mm
130mm, 5^{1/8}"

A 110°, vertical opening	252-570-120
B 70°, vertical opening	252-470-120
C 110°, horizontal opening	252-770-120
D 70°, horizontal opening	252-670-120

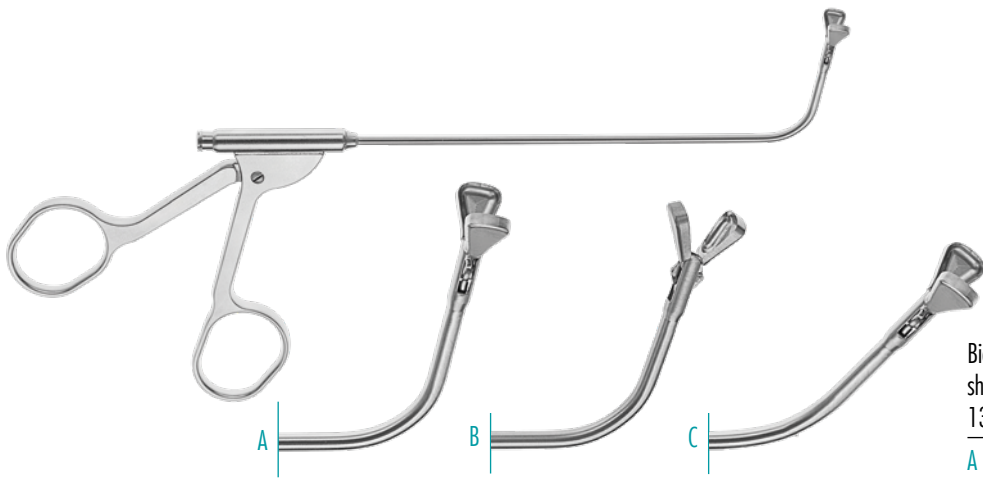

Biopsy Forceps, horizontal opening,
shaft 80° upcurved, pear-shaped
130mm, 5¹/₈"

A horizontal opening	252-473-130
B vertical opening	252-472-130
C 45° horizontal opening	252-471-130

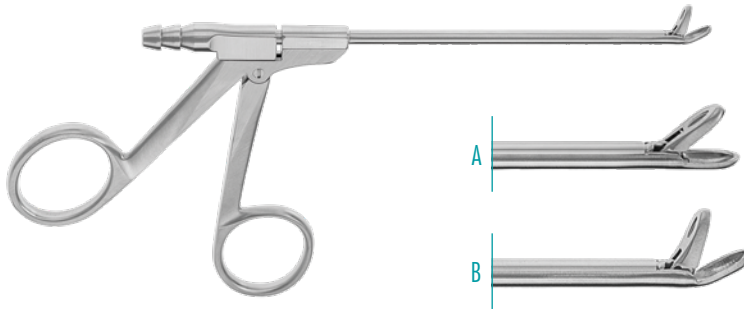

BLAKESLEY

Suction Punch, 3.5mm jaw,
Ø 4.0mm shaft

A straight	252-022-100
B curved up	252-122-100

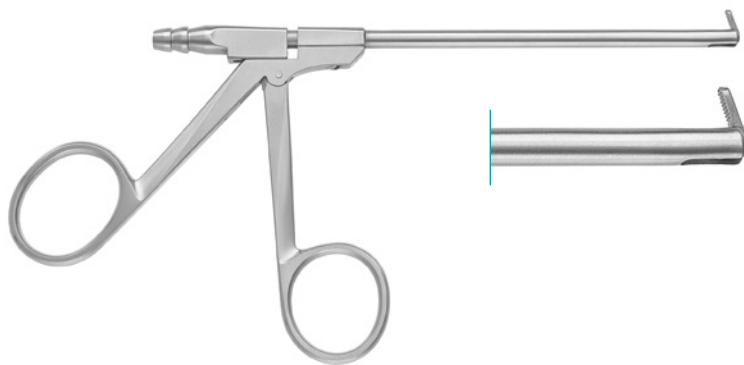

OSTROM

Suction Punch, 2.5mm jaw
Ø 5.0mm shaft

upside	252-015-500
right	252-015-520
left	252-015-510

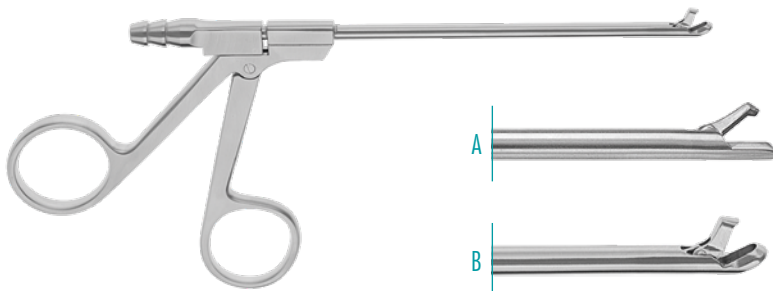

GRUENWALD

Suction Punch, 2.0mm jaw
Ø 4.0mm shaft, through-cutting

A straight	252-502-100
B upcurved	252-502-145

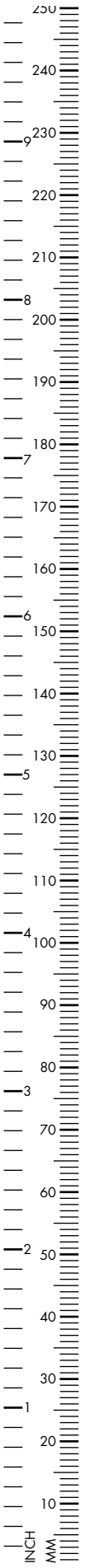

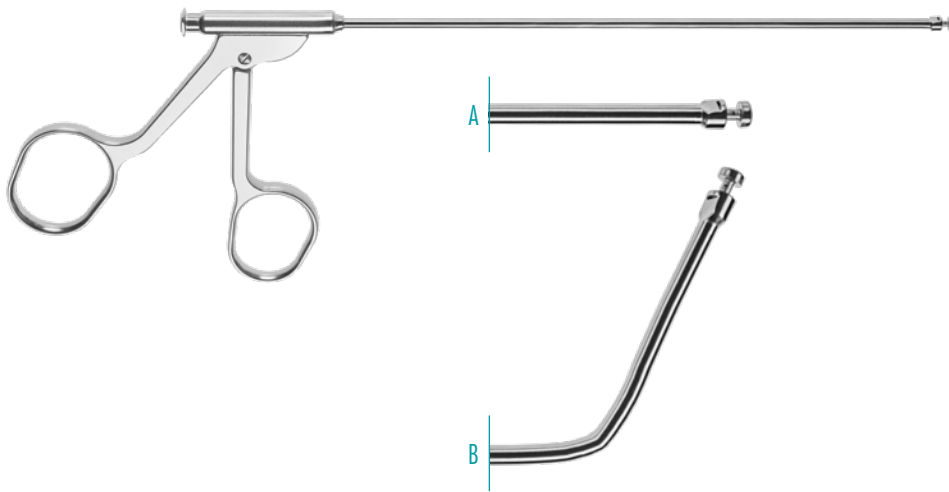

STAMMBERGER

Circular Punch, 160mm, 6¹/₄"

A straight

Ø 3.5mm 252-533-170

Ø 4.5mm 252-536-170

B 65° curved up

Ø 3.5mm 252-534-170

Ø 4.5mm 252-537-170

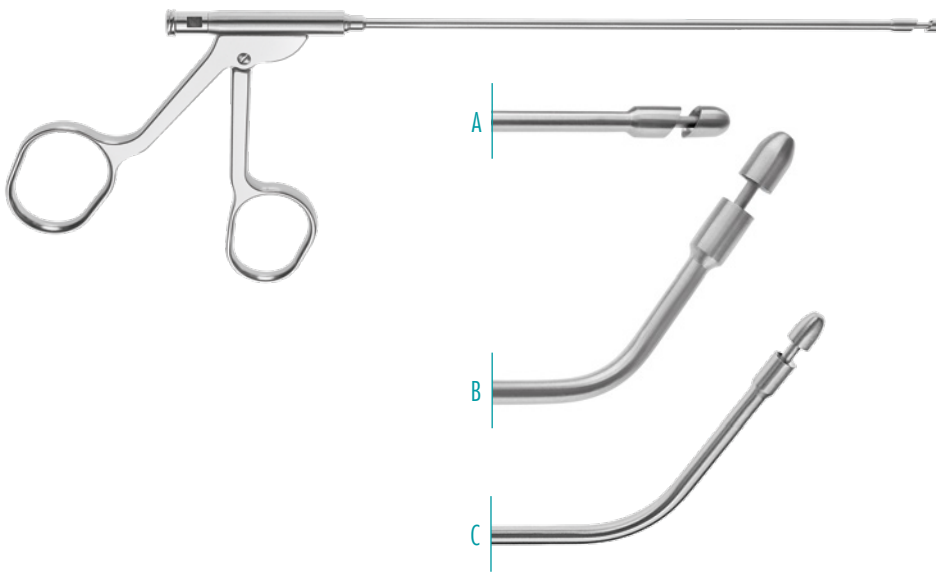

Circular Punch, 160mm, 6¹/₄"

A straight, 60° oblique bite

Ø 3.5mm 252-536-435

Ø 4.5mm 252-536-445

B 60° curved up

Ø 3.5mm 252-536-435

Ø 4.5mm 252-536-445

C 60° curved up, oval

Ø 3.5mm 252-537-335

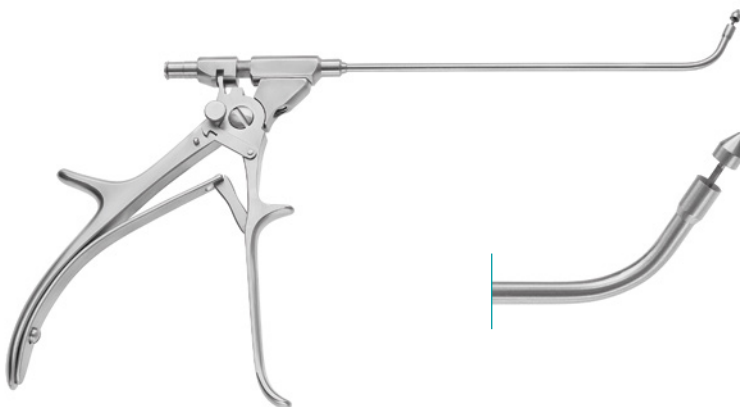

Circular Punch, 70° upturned shaft,
with Luer-Lock

Ø 3.5mm 252-534-270

Ø 4.5mm 252-537-270

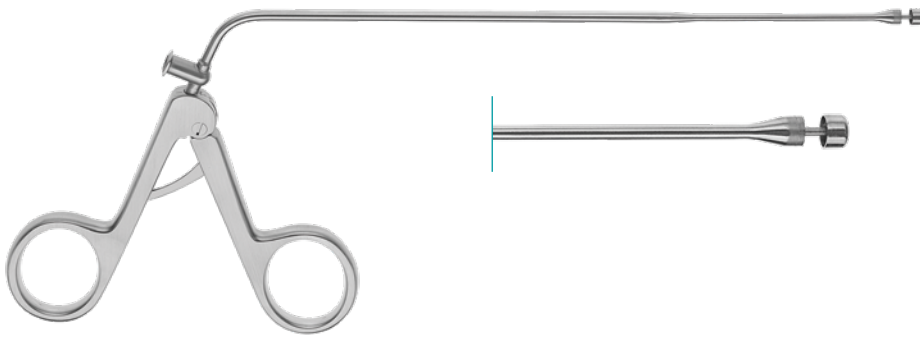

Circular Punch, straight, with Luer-Lock
180mm working length

Ø 3.5mm	252-536-235
Ø 4.5mm	252-536-245

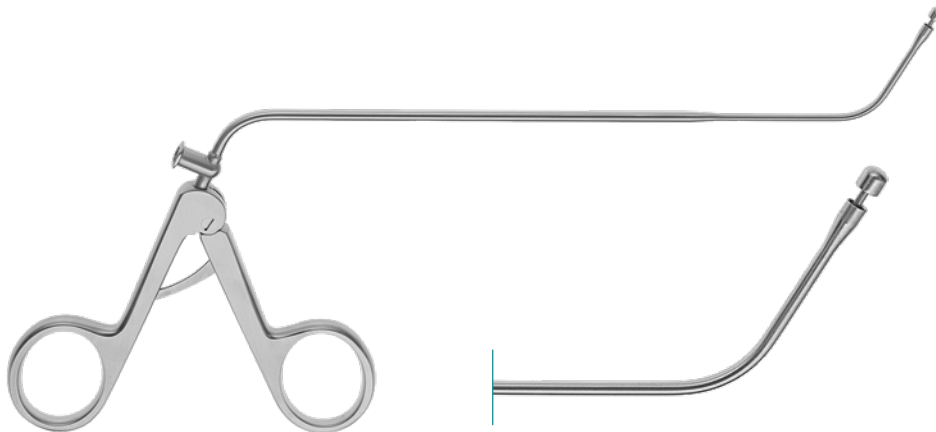

Circular Punch, 60° upcurved, with Luer-Lock
180mm working length

Ø 3.5mm	252-536-435
Ø 4.5mm	252-536-445

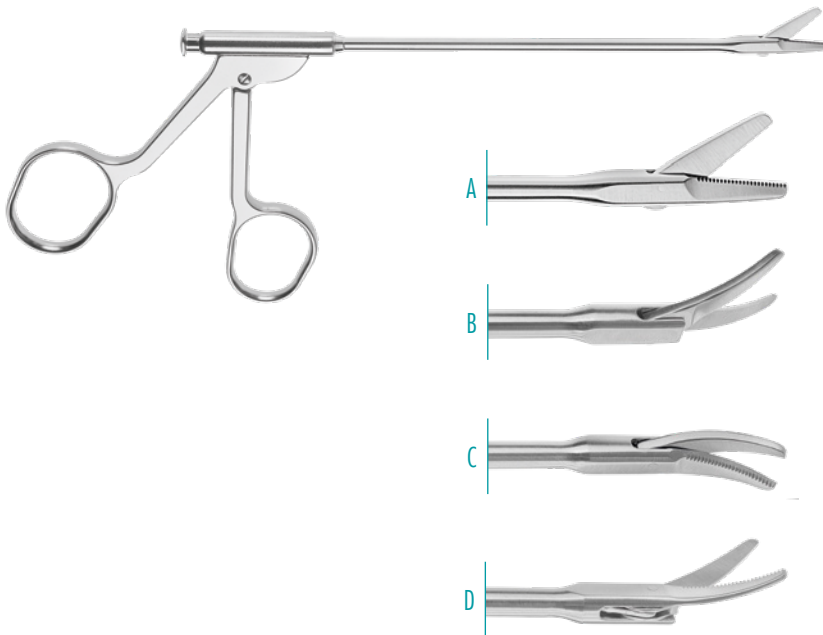

Nasal Scissors, Ø 3.5mm
130mm, 5¹/₈"

A straight	252-023-130
B left curved	252-024-130
C right curved	252-025-130
D curved up	252-026-130



OLIVECRONA

Nasal Scissors, serrated

230mm, 9"	120-208-230
-----------	-------------

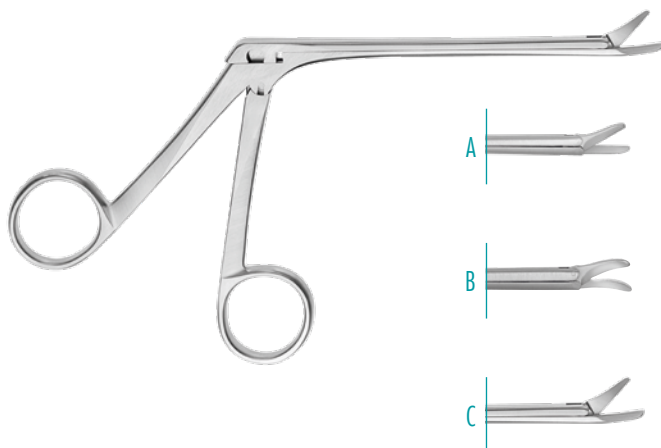

Nasal Scissors, serrated upper blade,
120mm, 4³/₄"

A straight	420-414-120
B right curved	420-415-120
C left curved	420-416-120

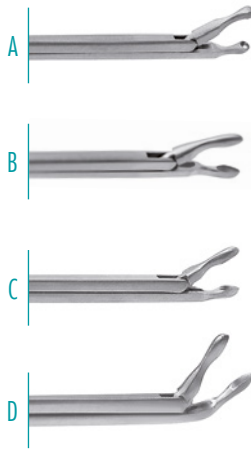
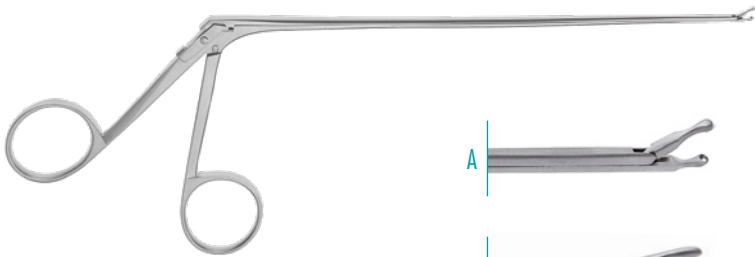
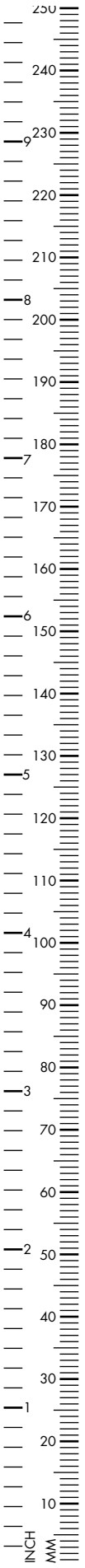

Oval Cup Forceps, 0.6mm jaw
160mm working length

A straight	252-810-160
B right curved	252-811-160
C left curved	252-813-160
D 45° upwards angled	252-815-160

190mm working length

A straight	252-810-190
B right curved	252-811-190
C left curved	252-813-190
D 45° upwards angled	252-815-190

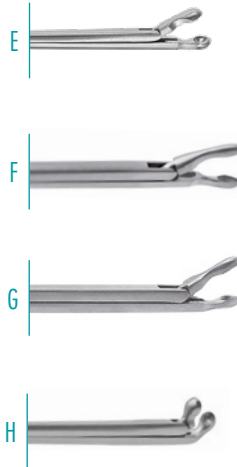
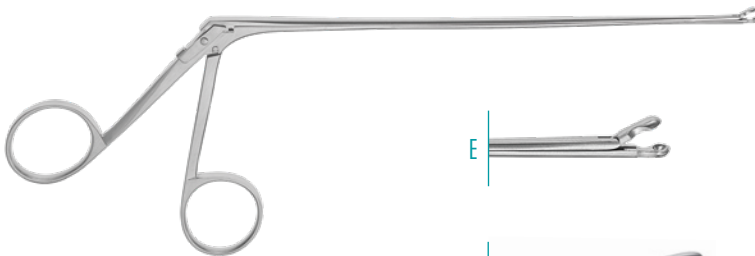

Oval Cup Forceps, 2.5mm jaw
160mm working length

E straight	252-816-160
F right curved	252-817-160
G left curved	252-818-160
H 45° upwards angled	252-819-160

190mm working length

E straight	252-816-190
F right curved	252-817-190
G left curved	252-818-190
H 45° upwards angled	252-819-190

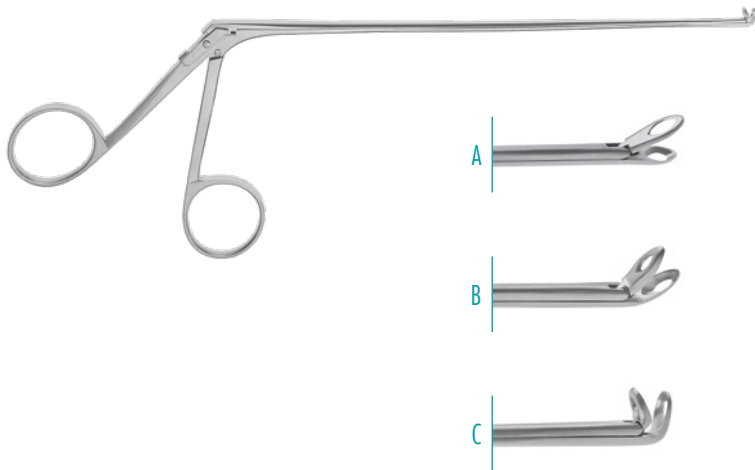
**STRÜMPEL**

Forceps, 2.5 x 7.0mm jaw,
160mm working length

A straight	252-820-160
B 60° upwards	252-821-160
C 90° upwards	252-823-160

190mm working length

A straight	252-820-190
B 60° upwards	252-821-190
C 90° upwards	252-823-190

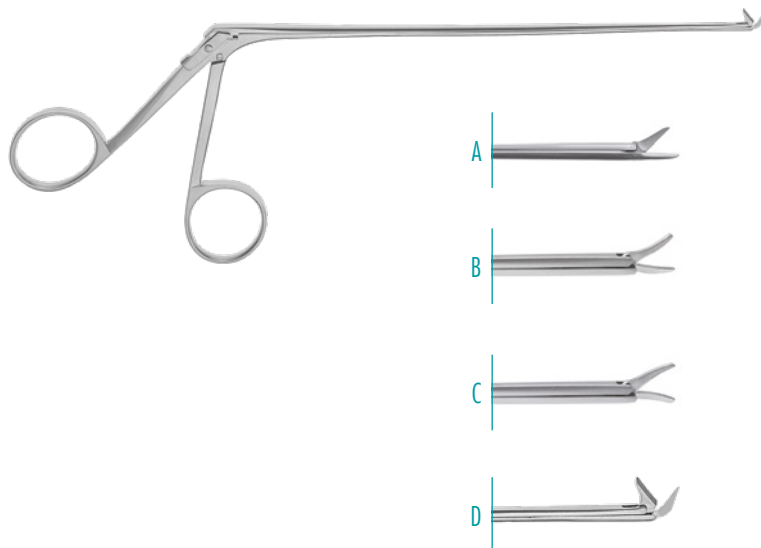

Scissors, 5mm blade,
160mm working length

A straight	252-830-160
B right curved	252-831-160
C left curved	252-833-160
D upwards angled	252-835-160

190mm working length

A straight	252-830-190
B right curved	252-831-190
C left curved	252-833-190
D upwards angled	252-835-190

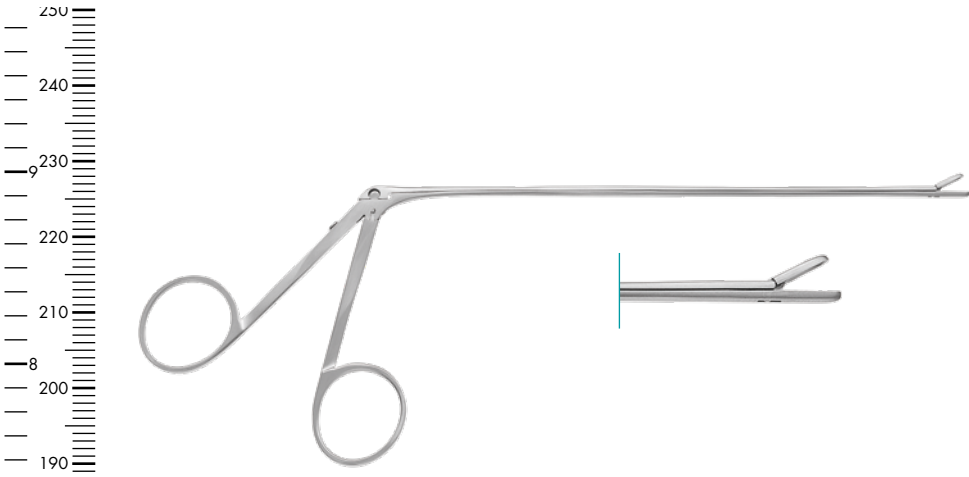

DECKER

Rongeur, fine model, 2x6mm jaw
150mm, 6"

straight	250-066-817
left curved	250-066-824
right curved	250-066-827

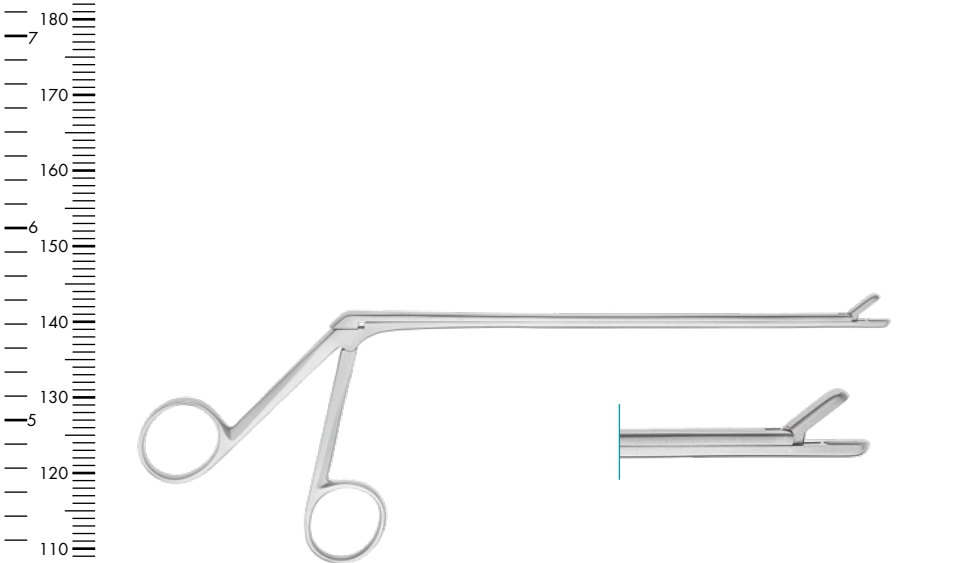

DECKER

Rongeur, 2x6mm jaw, straight

150mm, 6"	250-067-817
-----------	-------------

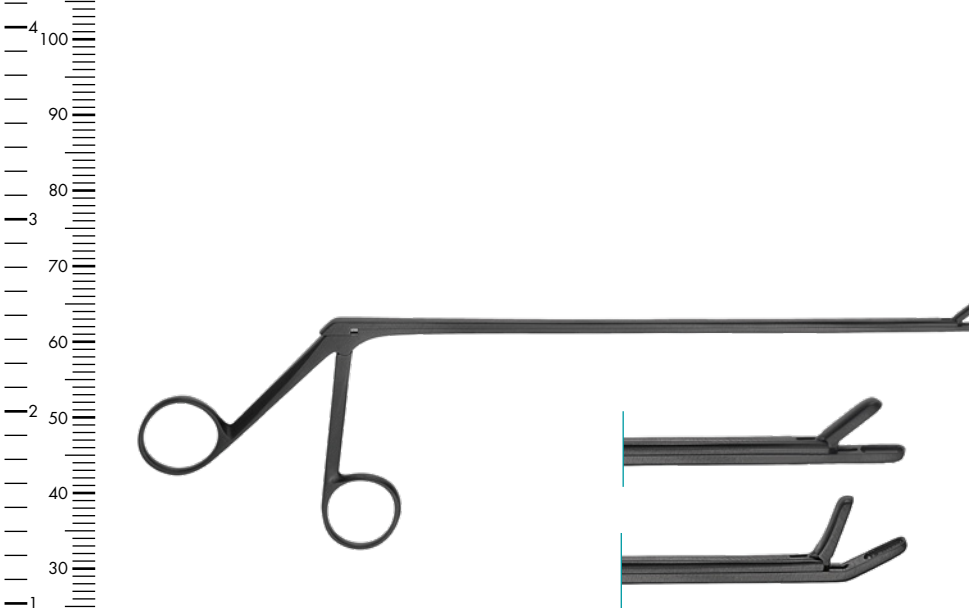

Micro Rongeur, CERA-CUT®
2mm jaw, 170mm, 6²/₃"

straight	250-300-170CC
upcurved	250-301-170CC

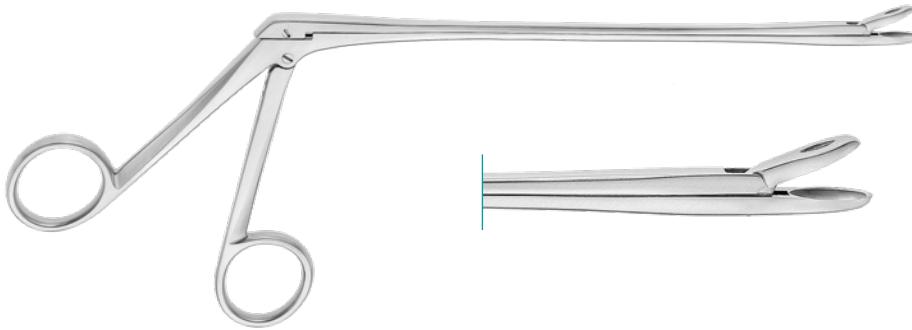
**WEIL BLAKESLEY**

Rongeur, fenestrated jaw,
180mm, 7", straight

3.0mm	252-030-180
3.5mm	252-035-180
4.0mm	252-040-180
upwards angled	
3.0mm	252-030-181
3.5mm	252-035-181
4.0mm	252-040-181

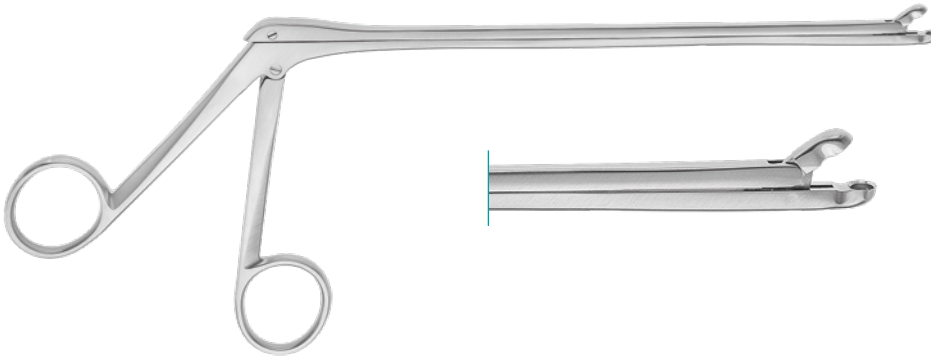
**YASARGIL**

Rongeur, 190mm, 7^{1/2}"

Ø2.2mm	250-066-599
Ø3.5mm	250-066-600

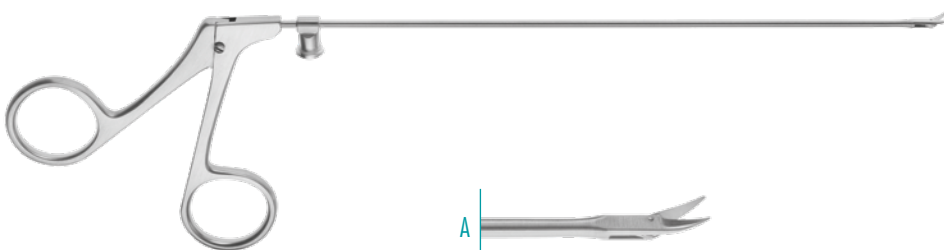

Micro Instrument with Luer-Lock
160mm, 6^{1/4}" working length

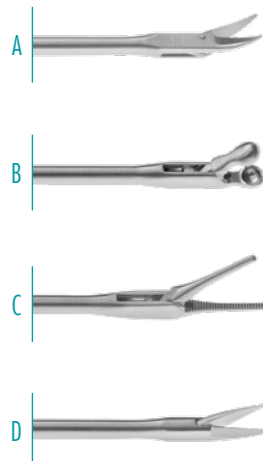

A
Micro Scissors

250-064-223

B NICOLA
Micro Forceps, Ø 2.5mm

250-064-222

C YASARGIL NICOLA
Micro Grasping Forceps, 1mm conical jaw

250-064-224

D NICOLA
Micro Scissors, straight

250-064-226

**CUSHING LANDOLT**

Specula for transsphenoidal hypophysectomy,
black finishing

70 x 15mm	250-150-100
90 x 15mm	250-150-101
100 x 15mm	250-150-102

**PAPAERO CASPAR**

Specula for trans-sphenoidal hypophysectomy,
stainless steel

80 x 11mm	250-150-589
90 x 13mm	250-150-590
100 x 15mm	250-150-591

black finishing

80 x 11mm	250-150-689
90 x 13mm	250-150-690
100 x 15mm	250-150-691

Key for specula

250-150-592



Transnasal Speculum, stainless steel, matted

80 x 9mm	250-150-280
90 x 9mm	250-150-290
100 x 9mm	250-150-300

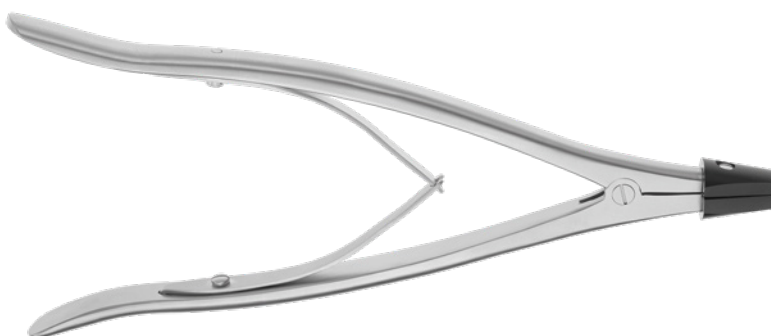
**LANDOLT**

Spreader for specula

210mm, 8 ¹ / ₄ "	250-150-210
--	-------------

BAYOSPHERE

Micro Instruments, bayonet-shaped, 100mm working length



A

B



Micro Spoon Forceps

A vertical

2mm	252-800-102
4mm	252-800-104
6mm	252-800-106

B horizontal

2mm	252-800-112
4mm	252-800-114
6mm	252-800-116



A

B

C

D

E



Micro Scissors

A sharp, straight	252-800-200
B sharp, left curved	252-800-201
C sharp, right curved	252-800-203
D sharp, horizontal	252-800-204
E blunt, straight	252-800-210

BAYOSPHERE

Micro Instruments, bayonet-shaped, 100mm working length

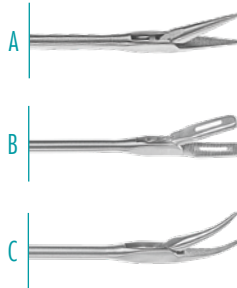

Micro Grasping Forceps

A	0.5mm, smooth	252-800-405
B	3.0mm, serrated	252-800-430
C	0.75mm, left curved	252-800-475

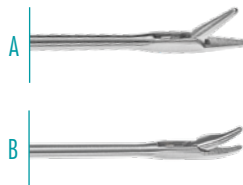

Micro Needle Holder

A	2x6mm, straight	252-800-510
B	1x6mm, left curved	252-800-511

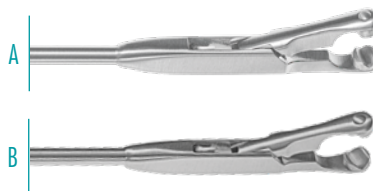

YASARGIL Clip Applying Forceps

A	Standard Clips	252-800-810
B	Mini Clips	252-800-820

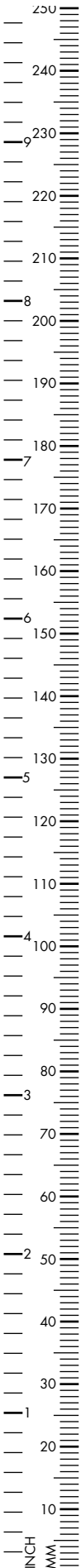

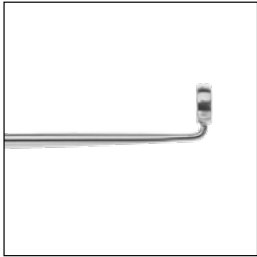
**HARDY**Ring Curette, bayonet-shaped, 240mm, 9¹/₂"

upwards angled

Ø 3mm 250-066-500

Ø 5mm 250-066-501

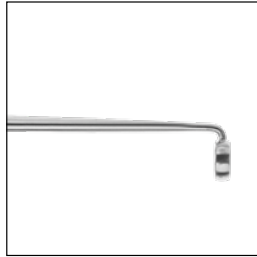

downwards angled

Ø 3mm 250-066-502

Ø 5mm 250-066-503

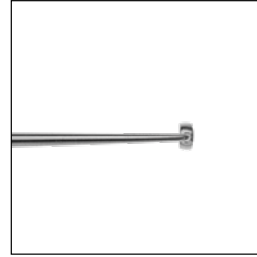

90° curved left

Ø 3mm 250-066-504

Ø 5mm 250-066-505



45° curved right

Ø 3mm 250-066-506

Ø 5mm 250-066-507

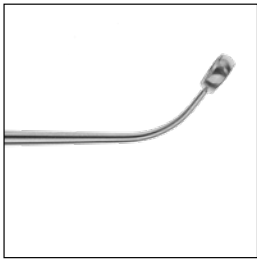

left curved

Ø 5mm 250-066-508

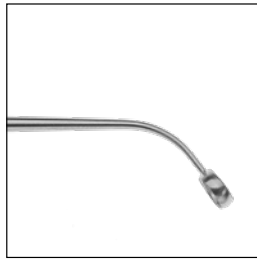

right curved

Ø 5mm 250-066-509

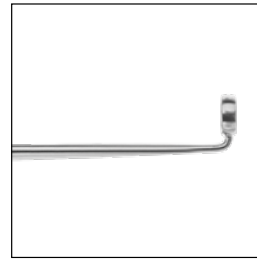
260mm, 10¹/₄" malleable

Ø 4mm 250-066-631

Ø 6mm 250-066-632

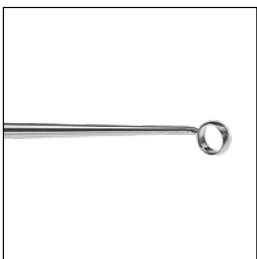
**RAY**Ring Curette, 190mm, 7¹/₂"

45° horizontal curved

Ø 4mm 250-066-611

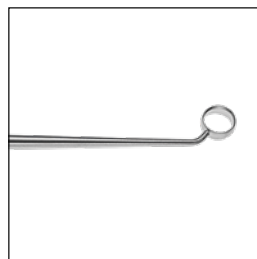

45° vertically curved

Ø 4mm 250-066-614

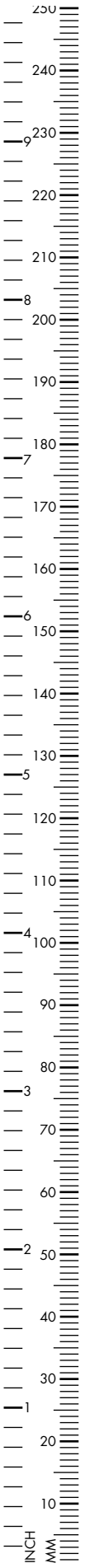

NICOLA
Ring Curette, 210mm, 8 1/4"

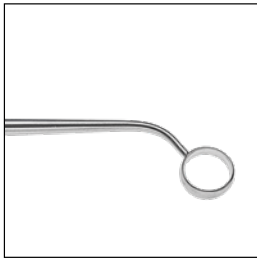

cutting to right
Ø 6.5mm 250-066-616

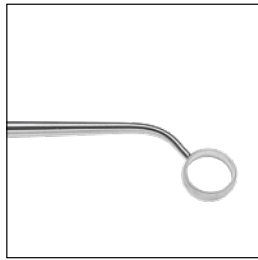

cutting to left
Ø 6.5mm 250-066-617

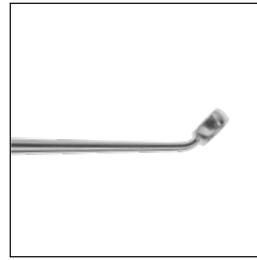

curved up
Ø 6.5mm 250-066-618

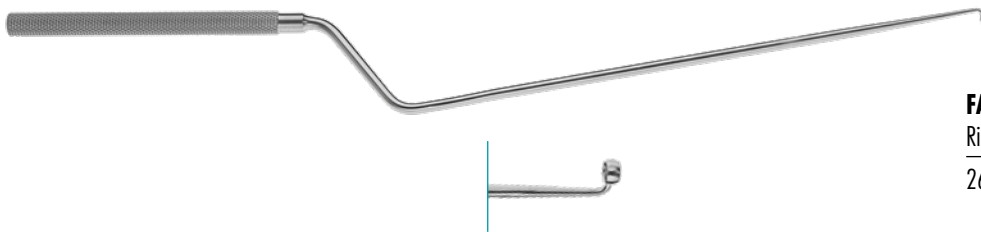

FAHLBUSCH
Ring Curette, 90°, Ø 2.5mm, malleable
260mm, 10 1/4" 250-066-637

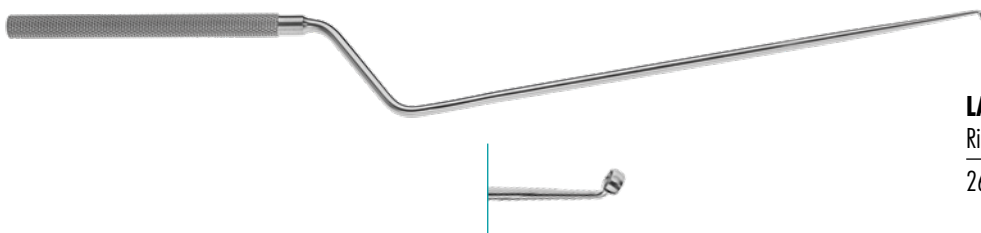

LANDOLT-REULEN
Ring Curette, 45°, Ø 2.5mm
260mm, 10 1/4" 250-066-642

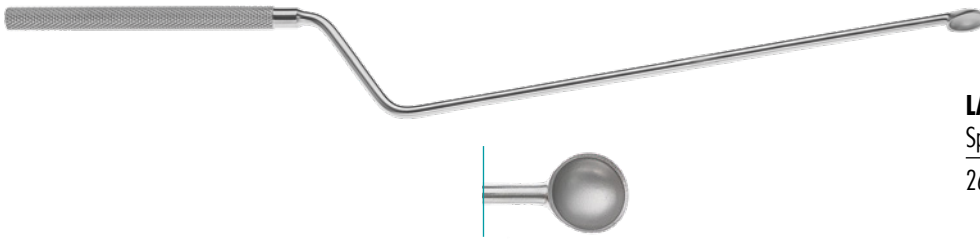
**LANDOLT**

Spoon, malleable

260mm, 10¹/₄"

250-066-628

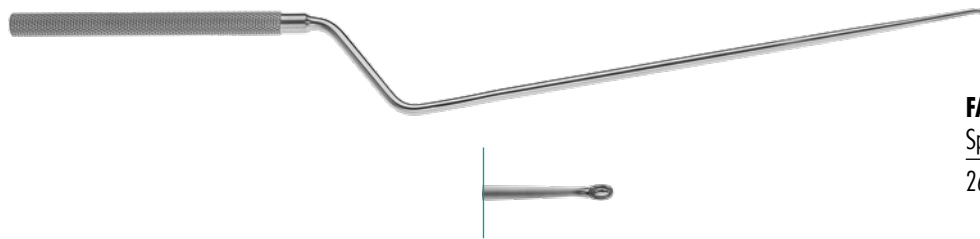
**FAHLBUSCH**

Spoon, malleable

260mm, 10¹/₄"

250-066-635

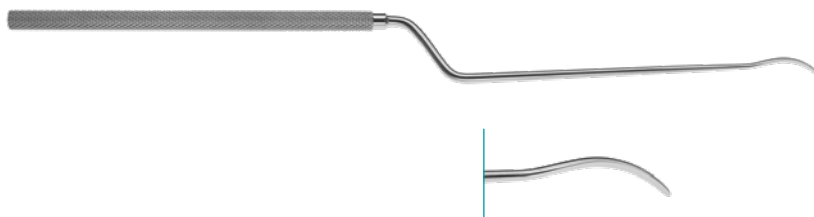
**NICOLA**

Raspatory, 2mm

215mm, 8¹/₂"

250-066-619

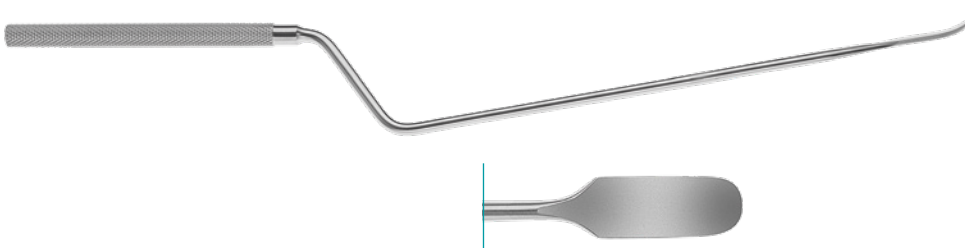
**LANDOLT**

Raspatory, malleable

260mm, 10¹/₄"

250-066-627

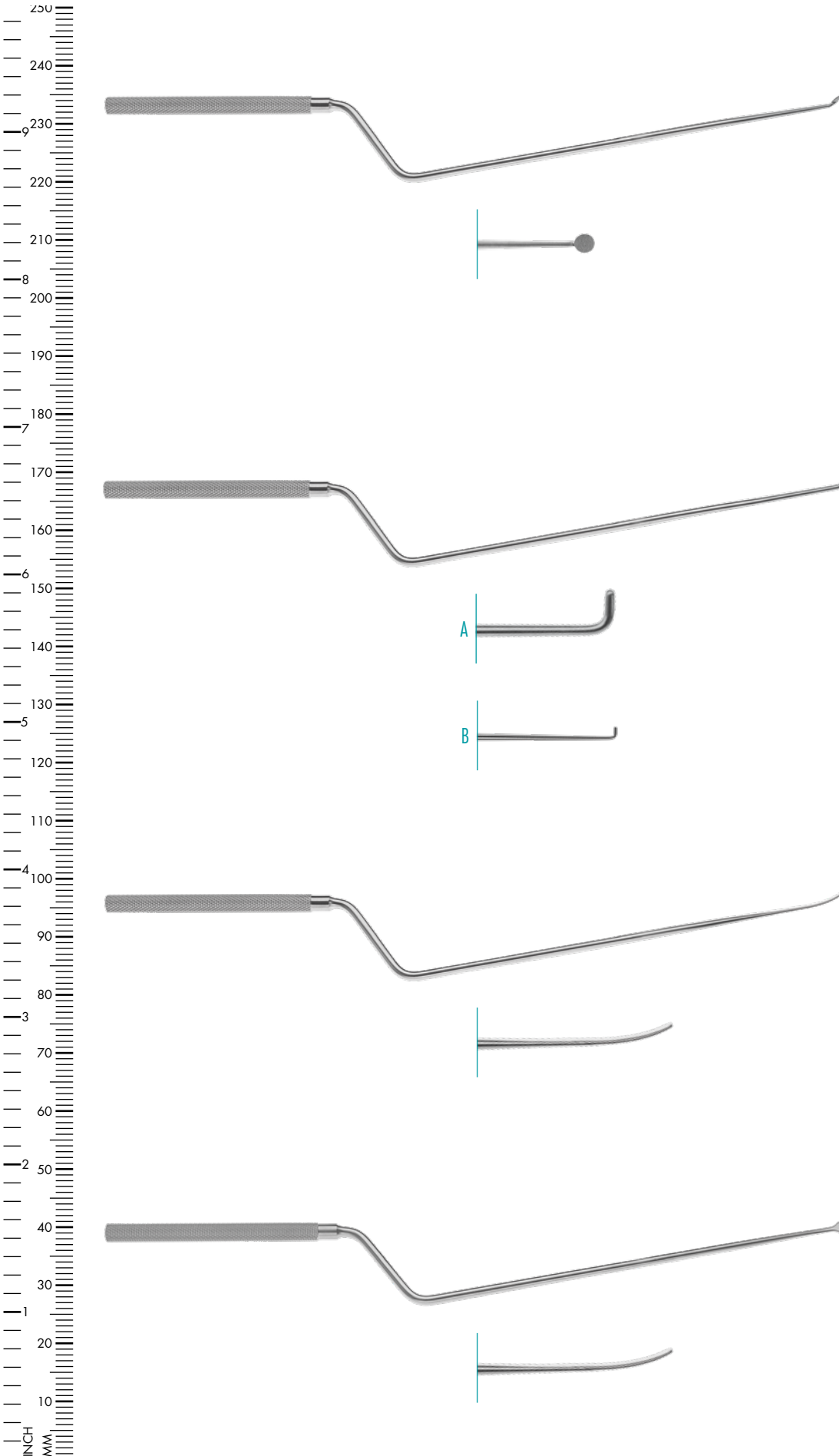

LANDOLT-REULEN

Raspator, 260mm, 10^{1/4}"
malleable

Ø 2.2mm 250-066-640

LANDOLT

Hook, blunt

A 260mm, 10^{1/4}" 250-066-629

LANDOLT-REULEN

Hook, blunt

B 260mm, 10^{1/4}" 250-066-643

LANDOLT-REULEN

Dissector, Ø 2.0mm

260mm, 10^{1/4}" 250-066-644

HOSOBUCHI

Fork Spatula

260mm, 10^{1/4}" 250-066-630

**HARDY**Enucleator, blunt, 245mm, 9²/₃"

A curved left 250-066-620

B curved right 250-066-621

HARDY-FAHLENBUSCHEnucleator, fine, sharpened inner edge,
245mm, 9²/₃"

C curved left 250-066-608

D curved right 250-066-609

**LANDOLT**Enucleator, malleable, 260mm, 10¹/₄"
blunt

A right 250-066-625

B left 250-066-655

sharp

A right 250-066-626

B left 250-066-656

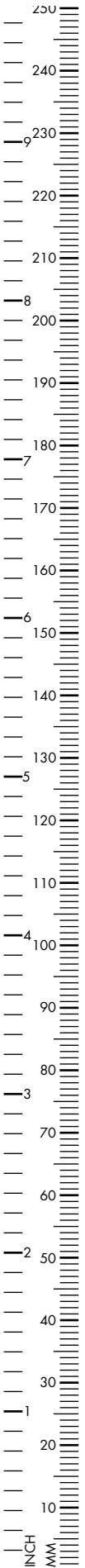

ORAL



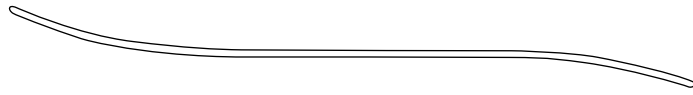
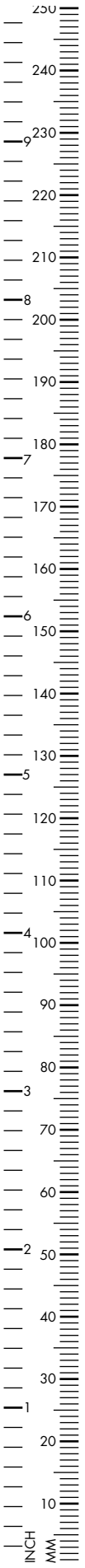

BUCHWALD

Tongue Depressor, 23 x 18mm

180mm, 7"

430-361-190



MAYO

Tongue Depressor, 23 x 19mm

170mm, 6²/₃"

430-362-170



BRUENINGS

Tongue Depressor

190mm, 7¹/₂"

430-385-190



MINNESOTA

Cheek Retractor, 14mm and 20mm wide,
double-ended

155mm, 6¹/₈"

430-155-000

**MORITZ-SCHMIDT**

Tongue Depressor

190mm, 7¹/₂"

430-397-190

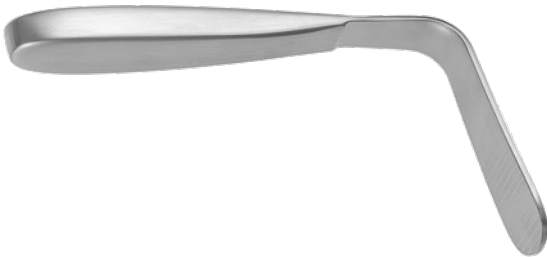
**TOBOLD**

Tongue Depressor

145mm, 5³/₄"

430-349-145

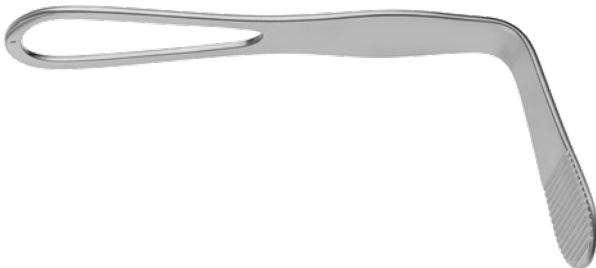
**HARTMANN**

Tongue Depressor, fenestrated handle

150mm, 6"

430-271-150

**WIEDER**

Tongue Depressor, fenestrated blade

125mm, 5"

30mm blade

430-297-140

36mm blade

430-297-150

**STIERLEN**

Tongue Depressor

55mm	430-350-005
70mm	430-350-007
90mm	430-350-009
100mm	430-350-010

**HEISTER**

Mouth Gag

130mm, 5 ¹ / ₈ "	430-150-130
--	-------------

**DOYEN-JANSEN**

Mouth Gag, children

120mm, 5 ¹ / ₈ "	430-140-110
--	-------------

adults

140mm, 5 ¹ / ₂ "	430-140-140
--	-------------

**DENHARDT**

Mouth Gag, silicone inserts, interchangeable

120mm, 4 ³ / ₄ "	430-142-120
--	-------------

**ROSER-KOENIG**

Mouth Gag

160mm, 6 ¹ / ₄ "	430-144-160
--	-------------

**JENNINGS**

Mouth Gag

90mm, 3 1/2"	430-250-090
110mm, 4 1/3"	430-250-110
130mm, 5 1/8"	430-250-130
150mm, 6"	430-250-150

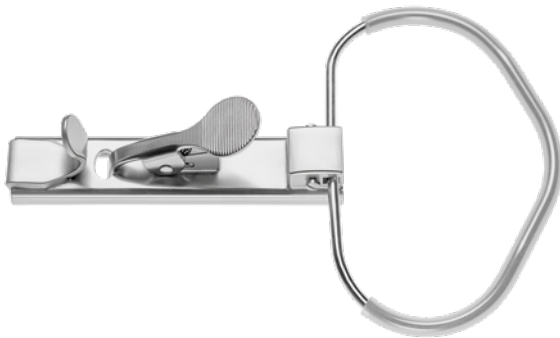
**MC IVOR**

Mouth Gag, frame only

430-256-010

**DAVIS-MEYER**

Mouth Gag, frame only

right	430-130-500
left	430-130-510



Sliding Tooth Hook

430-130-520



Palate Blade, for 430-130-500

430-130-560

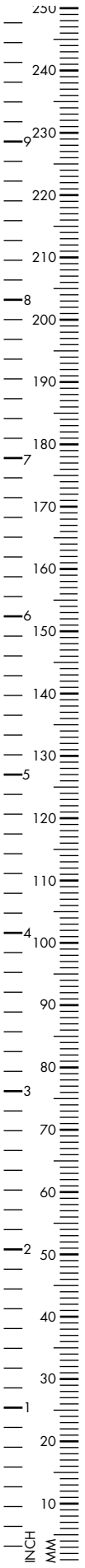

DAVIS-BOYLE

Mouth Gag, adults

left	430-310-010
right	430-310-011



Silicone Caps for Davis-Boyle mouth gag

430-310-012



DAVIS-BOYLE

Mouth Gag, small pattern for adolescent

430-310-009

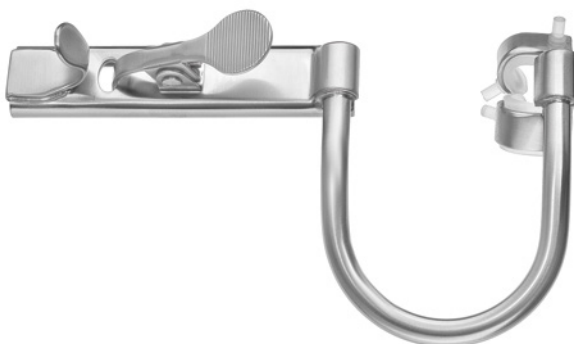

DAVIS-BOYLE

Mouth Gag, children

430-310-110

**KILNER-DOUGHTY**

Mouth Gag, left

430-315-010

**DINGMANN**

Mouth Gag, set with 3 blades

430-327-000

Mouth Gag only

430-327-004

Blades

24 x 62mm

430-327-001

28 x 65mm

430-327-002

31 x 75mm

430-327-003



OSTRA LARYNGO-PHARYNGOSCOPE RETRACTOR

- **Wide range of blades**
Tongue, vallecular and laryngeal
- **Adaptable design**
Accommodates different anatomical conditions and surgical techniques
- **Open lateral frame**
Enables free movement for robotic instruments and camera, ensuring an unobstructed view
- **Independent blade adjustment**
Precise control of angle and depth for customized exposure.
- **Secure fixation**
Fully compatible with the RZ Retractor Holder Set

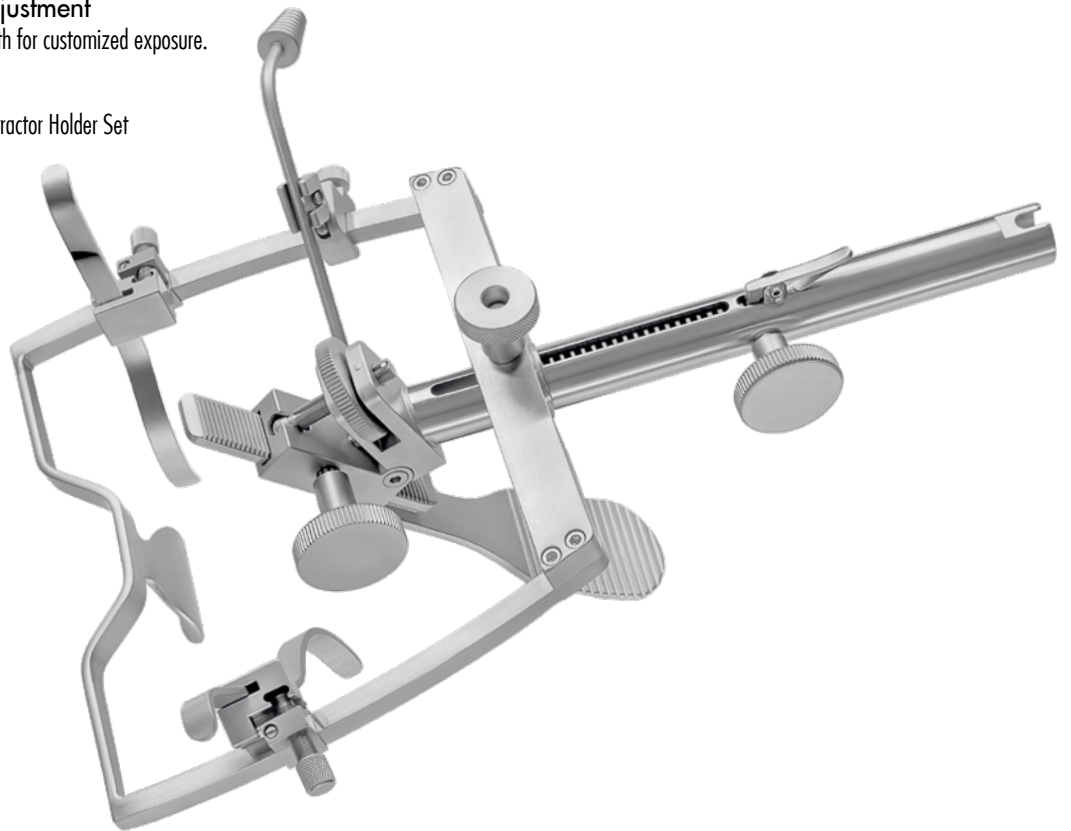

NATHANSON

Retractor Arm Set with table clamp

Table Clamp	170-801-503
single arm	170-801-501
double arm	170-801-502



- **Secure table fixation**
- **90° / 360° positioning flexibility**
- **Quick-lock attachment**

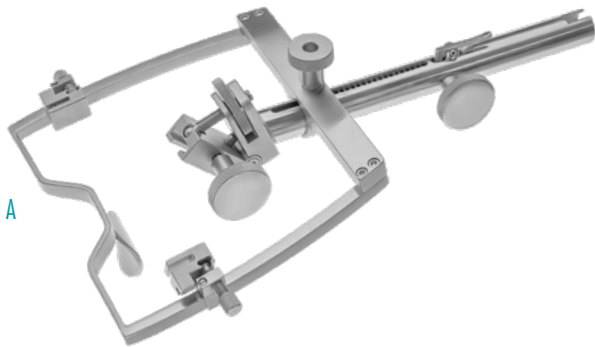

A



B



C



D



E



F



G



H



I



J



K



L



M



N

RZ OSTRÄLaryngo-Pharyngoscope Retractor,
complete set

430-326-000

A Basic frame
with adaptor 430-326-100B Adaptor for
Retractor Holder Set
170-801-501 430-326-002C Adaptor For Chest
Support 430-326-003D TORS blade,
small, left 430-326-004D TORS blade,
small, right 430-326-005E TORS blade,
large, left 430-326-006E TORS blade,
large, right 430-326-007F Tongue blade,
curved 430-326-008G Tongue blade,
curved, open right 430-326-009G Tongue blade,
curved, open left 430-326-010H Mandible blade,
110mm 430-326-011I Laryngeal blade,
170mm, concave 430-326-012J Diverticle blade,
concave, working
length 22 cm 430-326-013K Cheek retractor,
curved 430-326-014L Light clip, with
lateral cable connection 430-326-015M Adaptor for suction
tube or tumor grasping
forceps 430-326-016N Suction tube for
smoke, Ø4x170 mm 430-326-017

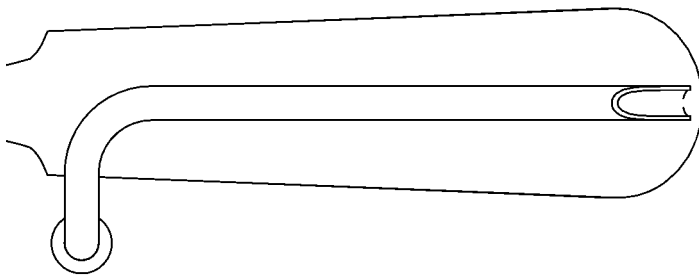
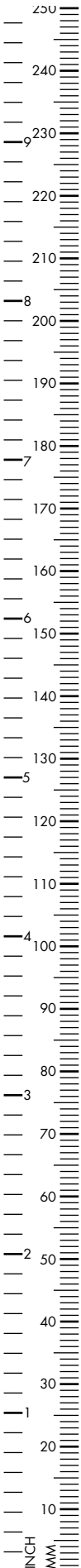

DAVIS-BOYLE

Tongue Blade, without anaesthesia channel

21 x 30mm 430-257-001

with anaesthesia channel

23 x 65mm 430-257-002

24 x 80mm 430-257-003

25 x 93mm 430-257-004

26 x 108mm 430-257-005



DAVIS-BOYLE

Tongue Blade

25 x 65mm 430-310-001

25 x 75mm 430-310-002

25 x 90mm 430-310-003

25 x 102mm 430-310-004



MC IVOR

Tongue Blade

23 x 55mm 430-256-001

25 x 65mm 430-256-002

26 x 75mm 430-256-003



HERBERHOLD

Tongue Blade

Fig. 1, 29 x 61mm 430-298-001

Fig. 2, 33 x 70mm 430-298-002

Fig. 3, 38 x 79mm 430-298-003

Fig. 4, 41 x 94mm 430-298-004

**DAVIS-MEYER**Tongue Blade, with tubing set
for anaesthesia channel

29 x 70mm	430-130-070
30 x 75mm	430-130-075
31 x 80mm	430-130-080
32 x 85mm	430-130-085
33 x 95mm	430-130-095
34 x 100mm	430-130-100
34 x 105mm	430-130-105

**KILNER-DOUGHTY**

Tongue Blade

28 x 65mm	430-315-001
23 x 75mm	430-315-002
37 x 80mm	430-315-003

**RUSSEL-DAVIS**

Tongue Blade, with groove

28 x 65mm	430-309-001
32 x 75mm	430-309-002
37 x 80mm	430-309-003
41 x 94mm	430-309-004
46 x 103mm	430-309-005

very narrow pattern

18 x 57mm	430-309-006
22 x 67mm	430-309-007
25 x 75mm	430-309-008
27 x 85mm	430-309-009

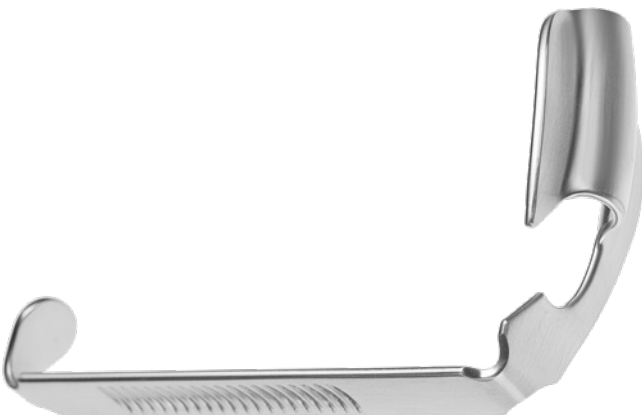

Tongue Blade, with groove

28 x 65mm	430-129-001
32 x 75mm	430-129-002
37 x 80mm	430-129-003

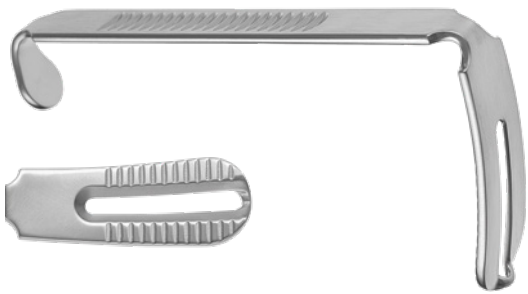
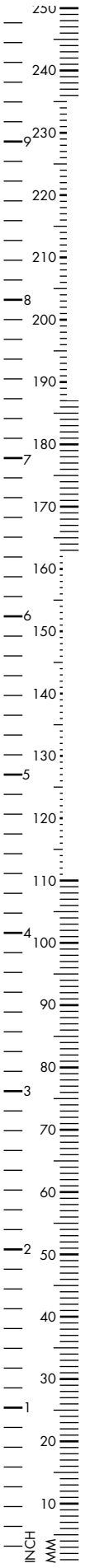

DOUGHTY

Tongue Blade, with slot

23 x 65mm	430-320-065
24 x 80mm	430-320-075
25 x 93mm	430-320-090
26 x 108mm	430-320-102
26 x 114mm	430-320-115

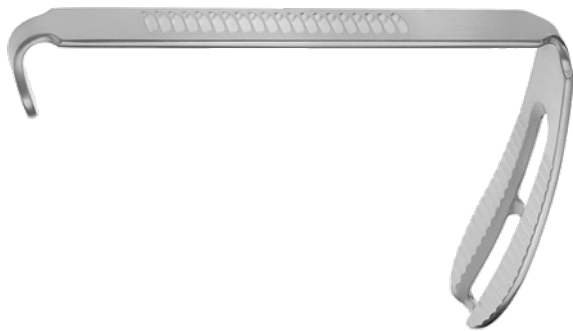

WÜRZBURG

Tongue Blade, slotted

136 x 71mm	430-325-001
136 x 77mm	430-325-002
136 x 86mm	430-325-003
136 x 96mm	430-325-004
136 x 106mm	430-325-005

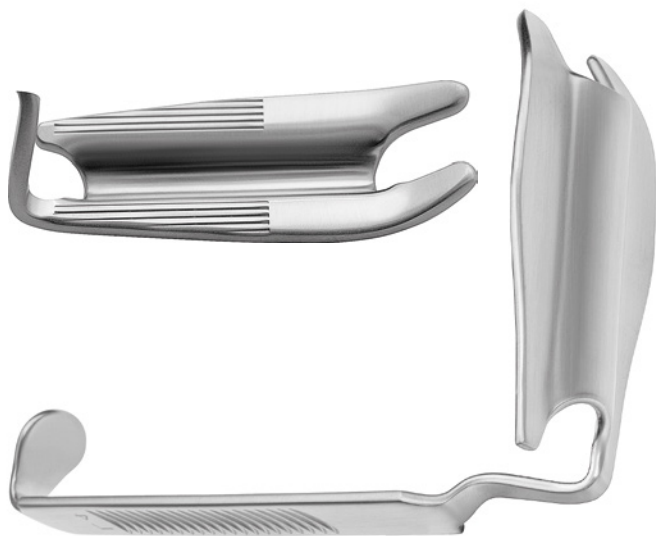

Tongue Blade, left

25 x 58mm	430-000-002
27 x 72mm	430-000-003
34 x 87mm	430-000-004
37 x 95mm	430-000-005

right

25 x 58mm	430-010-002
27 x 72mm	430-010-003
34 x 87mm	430-010-004
37 x 95mm	430-010-005



NEGUS
Chest Support

430-320-000

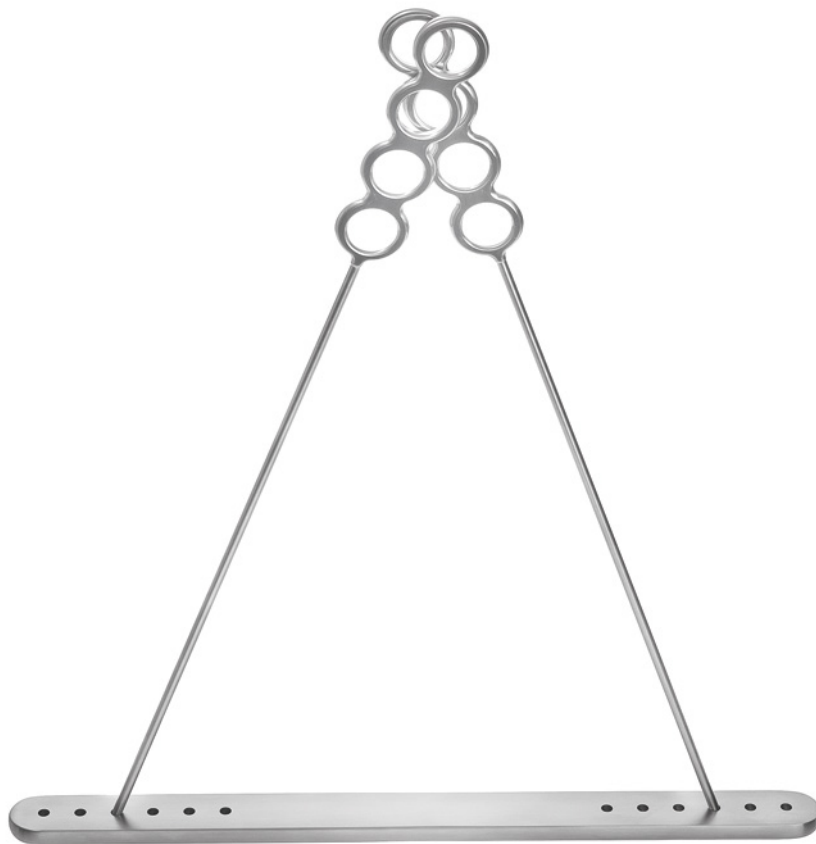

DRAFFIN
Holder for mouth gag, complete:
2 bars and plate

430-355-000

Bars only, pair

430-355-001

Magauran Plate

430-355-002

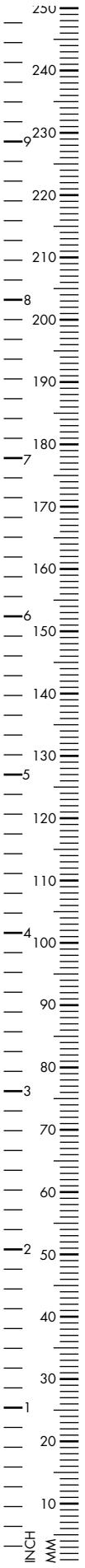

SEIFERT

Salivary duct probe, silver plated, \varnothing 1.0mm

180mm, 7" 410-045-180



BOWMAN

Lacrimal Probe, buttoned up

0000/000 400-497-008

00/0 400-497-003

0/1 400-497-001

1/2 400-497-012

2/3 400-497-023

3/4 400-497-034

4/5 400-497-045

5/6 400-497-056

6/7 400-497-067

7/8 400-497-078



WILDER

Dilator

Fig. 1 400-713-001

Fig. 2 400-713-002

Fig. 3 400-713-003



PERWITZSCHKY

Salivary Scissors

100mm, 4" 420-100-100



**PERWITZSCHKY**

Salival Scissors

100mm, 4"

420-100-100



Scalpel Handle No.7

165mm, 6 1/2"

110-130-077



Scalpel Handle No.3L

210mm, 6 1/4"

110-116-033

**FISCHER**

Tonsil Knife, serrated blade

225mm, 8 7/8"

430-656-190

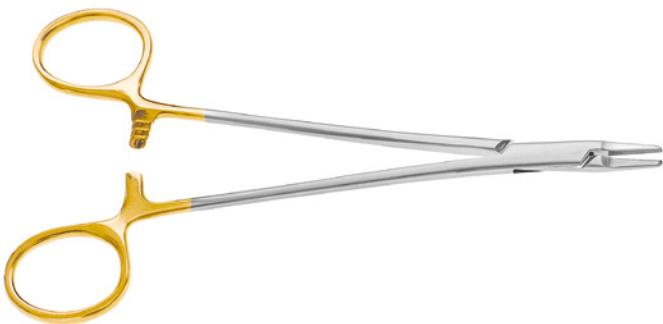
**RYDER**

TC Needle Holder, 2.0mm tip, serrated jaw, straight

180mm, 7"

180-560-180

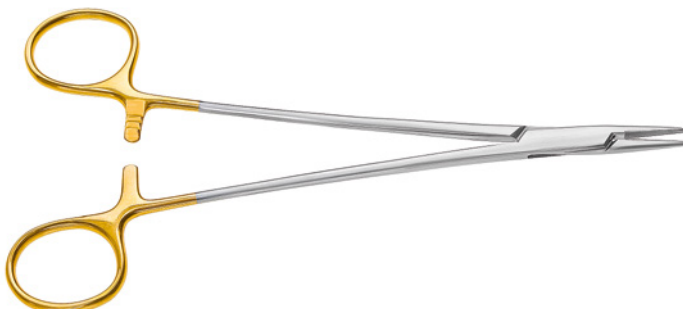
**DEBAKEY**

TC Needle Holder, serrated, straight

180mm, 7"

180-548-180

**NAGER**

Uvula Retractor

210mm, 8¹/₄"

430-524-210

**HOFER**

Uvula Retractor

240mm, 9¹/₂"

430-300-230

**SCHÖNBORN**

Uvula Retractor, 13 x 6mm

210mm, 8¹/₄"

430-245-200

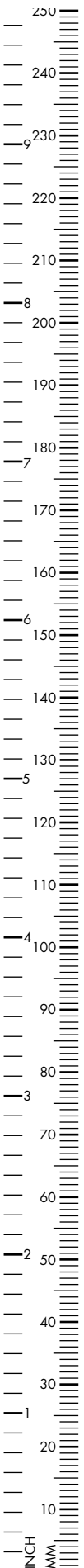

**BECKMANN**Adenoid Curette, straight, 220mm, 8²/₃"

Fig. 1, 8mm	420-220-010
Fig. 2, 10mm	420-220-020
Fig. 3, 12mm	420-220-030
Fig. 4, 14mm	420-220-040
Fig. 5, 16mm	420-220-050
Fig. 6, 18mm	420-220-060
Fig. 7, 19.5mm	420-220-070

**BECKMANN**Adenoid Curette, curved, 220mm, 8²/₃"

Fig. 1, 8mm	420-221-010
Fig. 2, 10mm	420-221-020
Fig. 3, 12mm	420-221-030
Fig. 4, 14mm	420-221-040
Fig. 5, 16mm	420-221-050
Fig. 6, 18mm	420-221-060
Fig. 7, 19.5mm	420-221-070

**BARNHILL**Adenoid Curette, 220mm, 8²/₃"

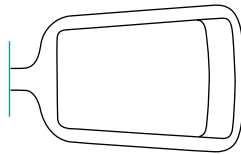
Fig. 0	420-222-000
Fig. 1	420-222-001
Fig. 2	420-222-002
Fig. 3	420-222-003
Fig. 4	420-222-004

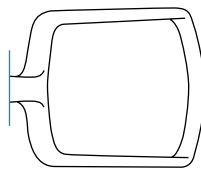

LA FORCE

Adenotome, 230mm, 9"

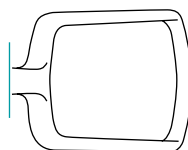
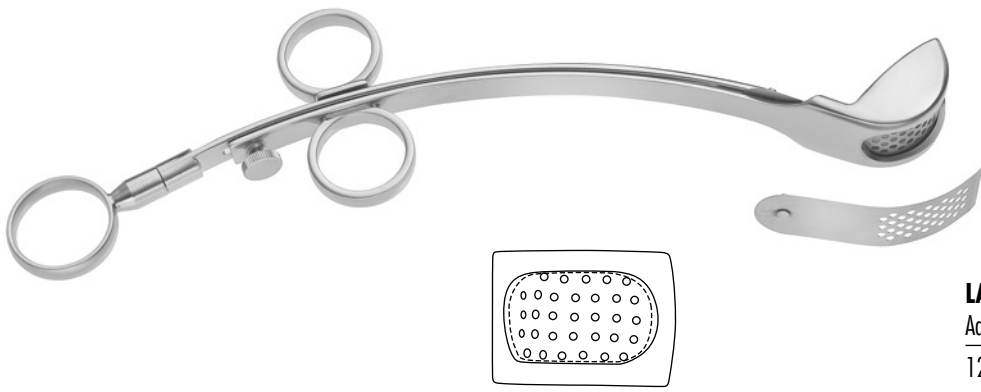
12mm	420-226-001
16mm	420-226-002
18mm	420-226-003

Spare Blades

for 420-226-001	420-226-101
for 420-226-002	420-226-102
for 420-226-003	420-226-103



SHAMBOUGH

Adenotome

Fig. 1, 13mm	420-228-000
Fig. 2, 16mm	420-228-000
Fig. 3, 19mm	420-229-100

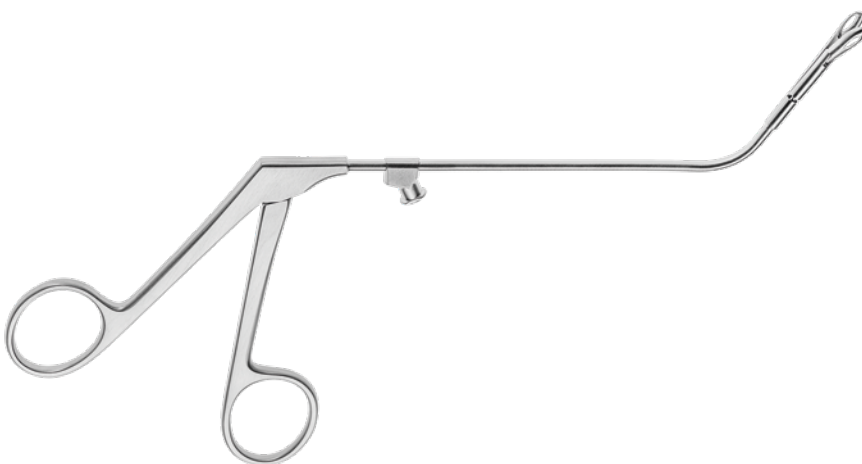

JATHO

Nasopharynx Forceps

240mm, 9 1/2"	420-395-240
---------------	-------------



JURASZ

Adenoid Cutting Forceps, children

190mm, 7¹/₂"

420-396-190

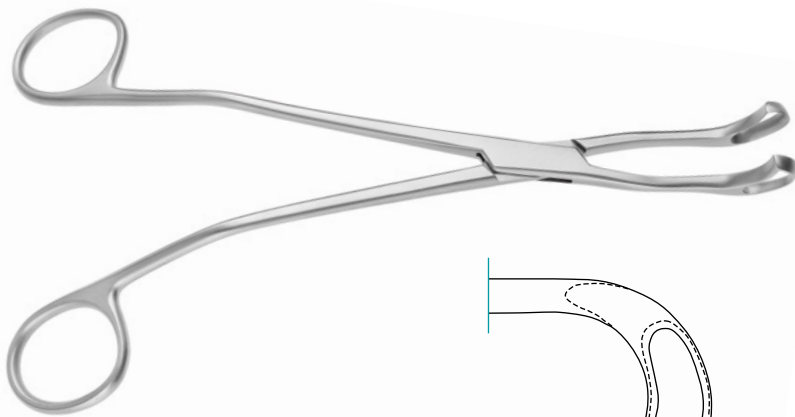

JURASZ

Adenoid Cutting Forceps, 210mm, 8¹/₄"

Fig. 1

420-397-210

Fig. 2

420-398-210

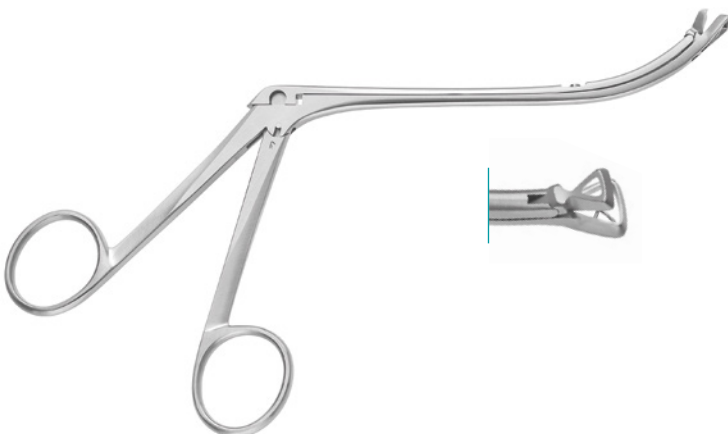

RONIS

Adenoid Forceps, through cutting, upcurved shaft, triangular bite, 130mm working length

Fig. 0, 6mm

420-391-000

Fig. 1, 7mm

420-391-001

Fig. 2, 8mm

420-391-002

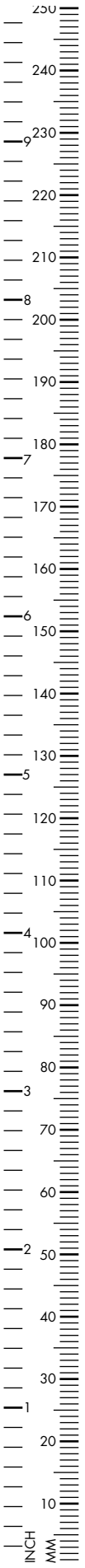

KING

Adenoid Forceps, through cutting, downcurved shaft, triangular bite, 130mm working length

Fig. 1, 7mm 420-391-115

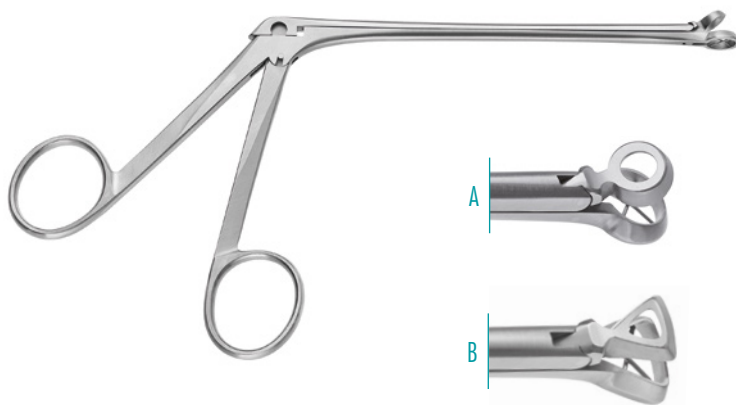

MELZER

A Adenoid Forceps, through cutting, round, 140mm, 5 1/2"

Fig. 1, 7mm 420-401-001
Fig. 2, 8mm 420-401-002

B through cutting, triangular

Fig. 0, 6mm 420-401-100
Fig. 1, 7mm 420-401-101
Fig. 2, 8mm 420-401-102
Fig. 3, 10mm 420-401-103

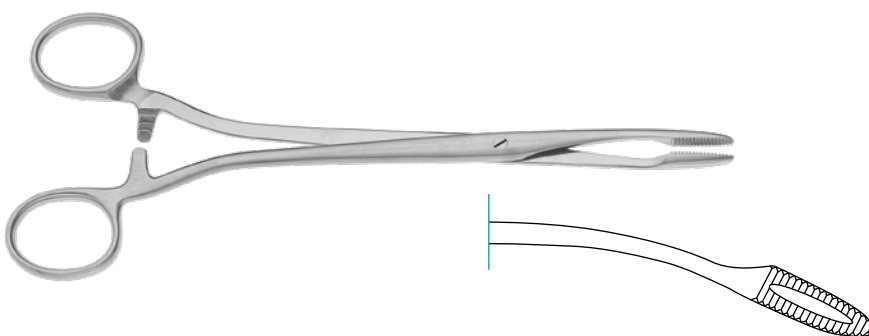

DUPLAY

Dressing Forceps, 200mm, 8"

straight 150-130-200
curved 150-131-200

**DUPLAY**

Nasopharyngeal Sponge Holding Forceps,
s-shaped

190mm, 7¹/₂"

420-398-190

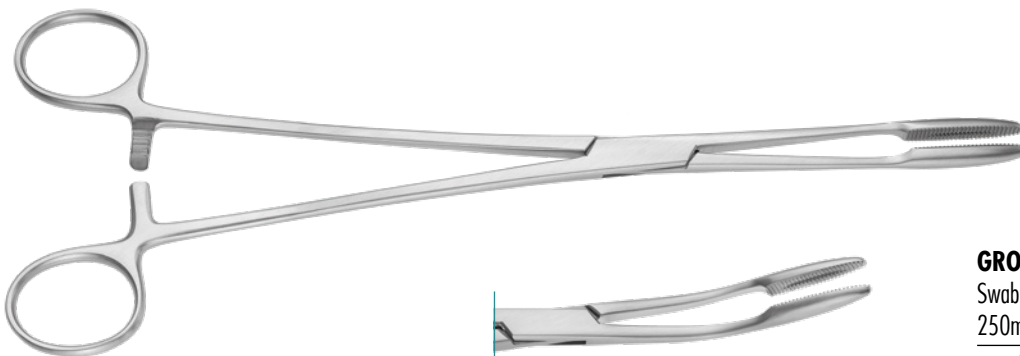
**GROSS MAIER**

Swab Forceps, serrated, straight,
250mm, 9⁷/₈"

straight

150-030-250

curved

150-031-250

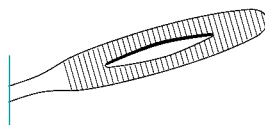
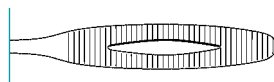

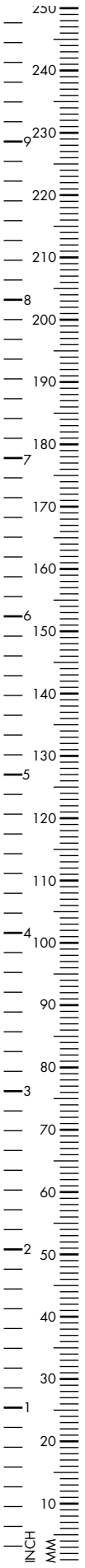

Dressing Forceps, serrated
200mm, 8" 130-010-200



Standard Dressing Forceps, delicate, straight
200mm, 8" 130-014-200



Tissue Forceps, 1x2 teeth
200mm, 8" 130-110-200

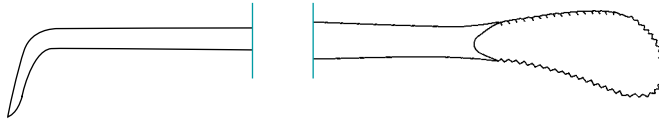

Tissue Forceps, 1x2 teeth, delicate
200mm, 8" 130-120-200

**HENKE**

Tonsil Dissector / Pillar Retractor,
235mm, 9¹/₄"

12mm	430-600-230
17mm	430-601-230

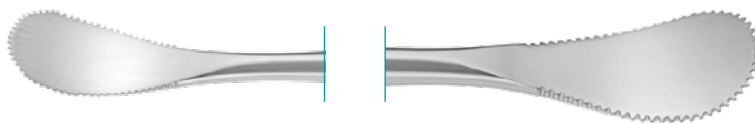
**HENKE**

Tonsil Dissector, double-ended
12mm / 18mm

230mm, 9"	430-602-230
-----------	-------------

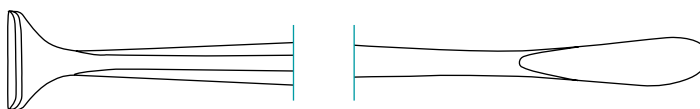
**HURD**

Tonsil Dissector / Pillar Retractor,
215mm, 8¹/₂"

7.5mm	430-600-215
10mm	430-601-220

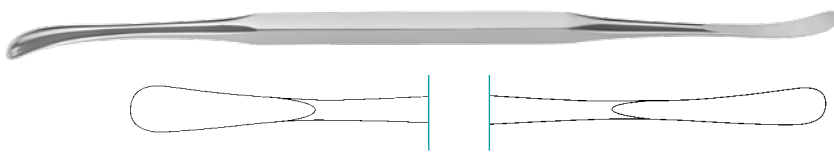
**ALDERDICE**

Tonsil Dissector

220mm, 8²/₃"

430-510-220

**LOPEZ-REINKE**

Tonsil Suction Dissector

235mm, 9¹/₄"

430-670-235

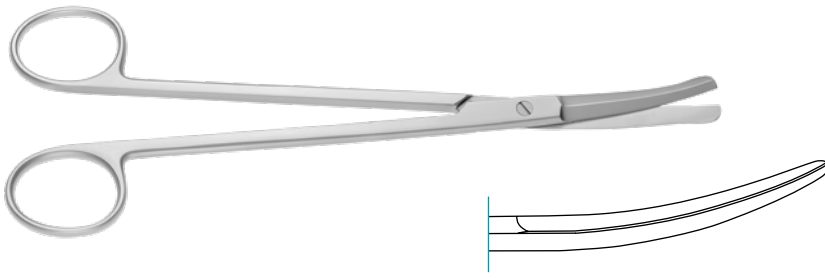
**GOOD**

Tonsil Scissors

190mm, 7¹/₂"

120-217-190

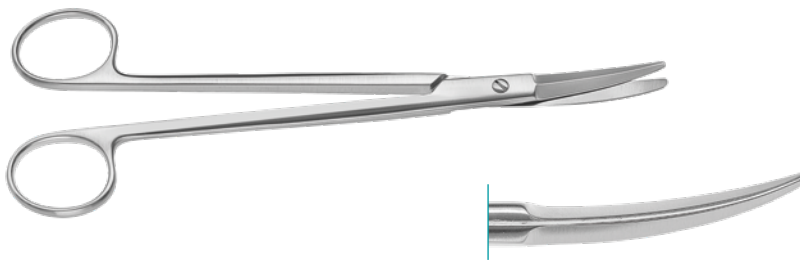
**PRINCE**

Tonsil Scissors

175mm, 6⁷/₈"

120-213-175

**BOETTCHER**

Tonsil Scissors, sharp

180mm, 7"

120-207-180

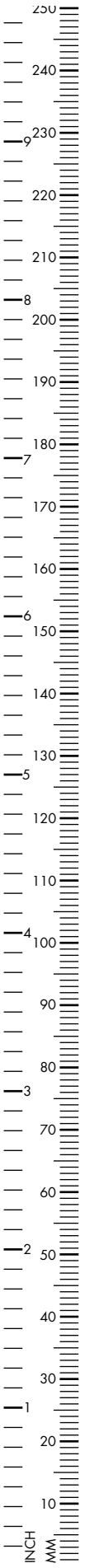

BOETTCHER

Tonsill Scissors, curved, 180mm, 7"

120-209-180

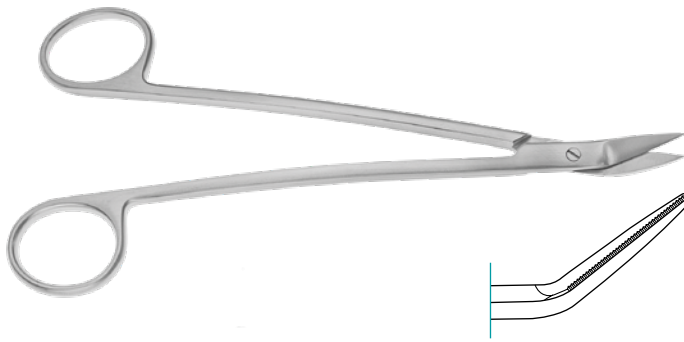

DEAN

Tonsil Scissors, angled upwards,
serrated blades

170mm, 6²/₃"

120-213-170



METZENBAUM NELSON

blunt, curved

180mm, 7"

120-111-180

200mm, 8"

120-111-200

230mm, 9"

120-111-230

Supercut

180mm, 7"

121-111-180

200mm, 8"

121-111-200

230mm, 9"

121-111-230

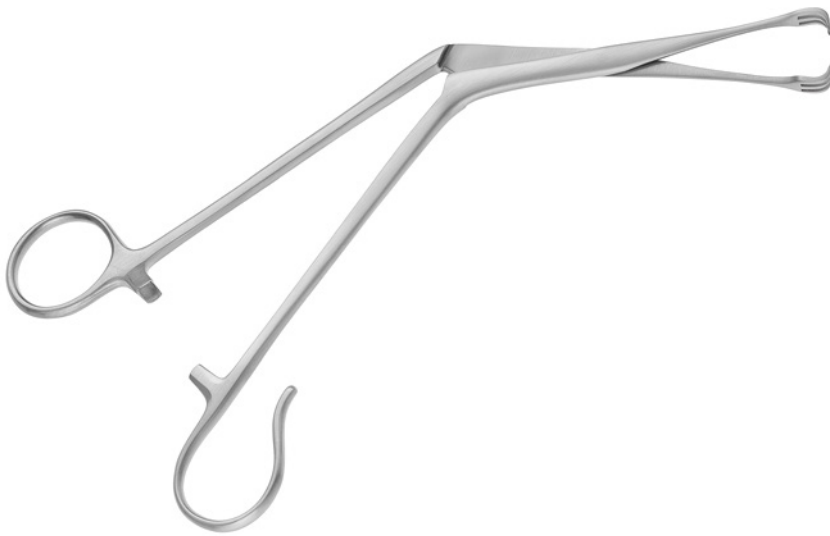
**TIVNEN-TYDING**

Tonsil Seizing Forceps, 3x3 teeth, 1 open ring

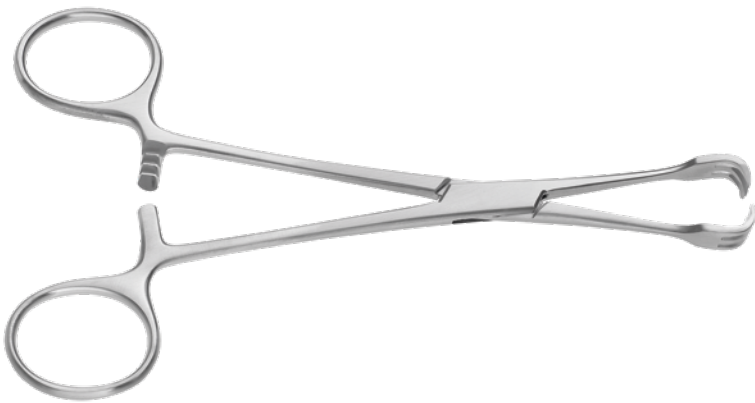
210mm, 8^{1/4}" 430-631-002**LAHEY**

Goitre Seizing Forceps

200mm, 8" 440-030-200

**MUSEUX**

Tonsil Holding Forceps, 2x2 teeth

200mm, 8" 140-602-200

**DENIS-BROWNE**

Tonsil Holding Forceps, 10mm

200mm, 8" 420-427-200

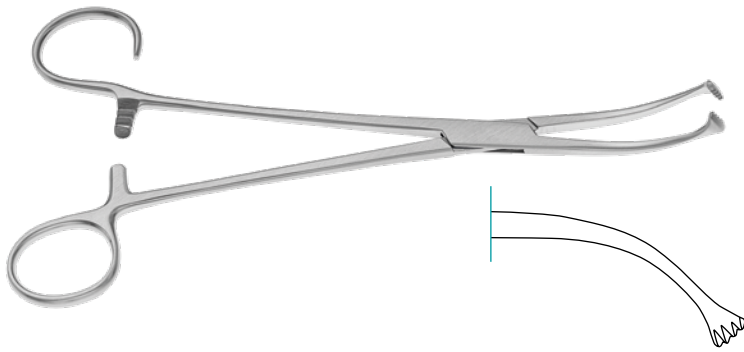
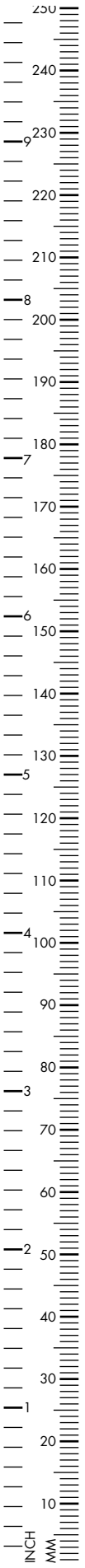

COLVER

Tonsil Seizing Forceps, curved

190mm, 7¹/₂"

140-626-190

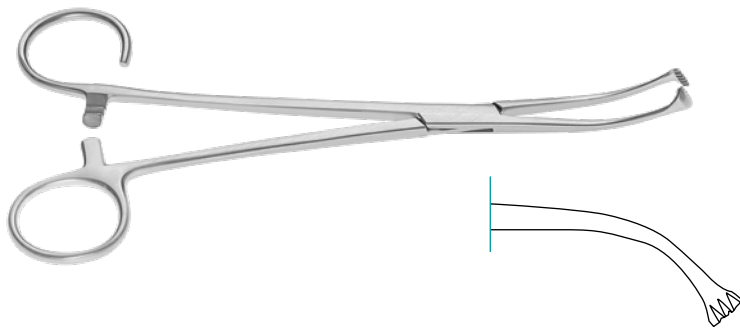

WHITE

Tonsil Holding Forceps

180mm, 7"

140-620-180

235mm, 9¹/₄"

140-620-235

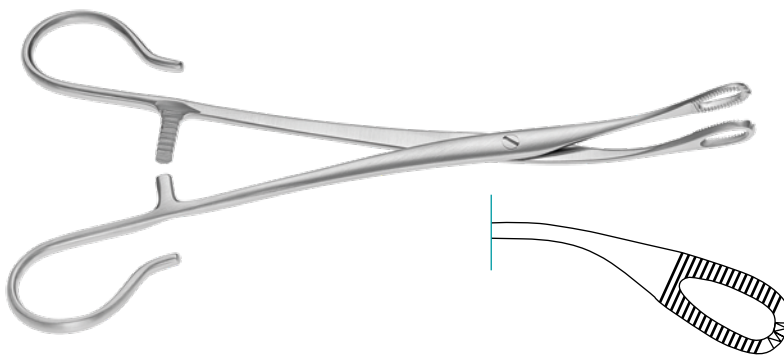

BLOHMKE

Tonsil Holding Forceps

200mm, 8"

140-625-200

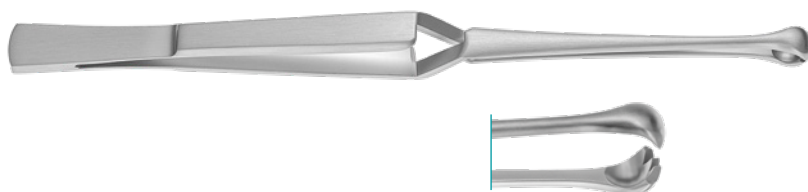

MARSCHIK

Tonsil Grasping Forceps

220mm, 8²/₃"

430-620-220

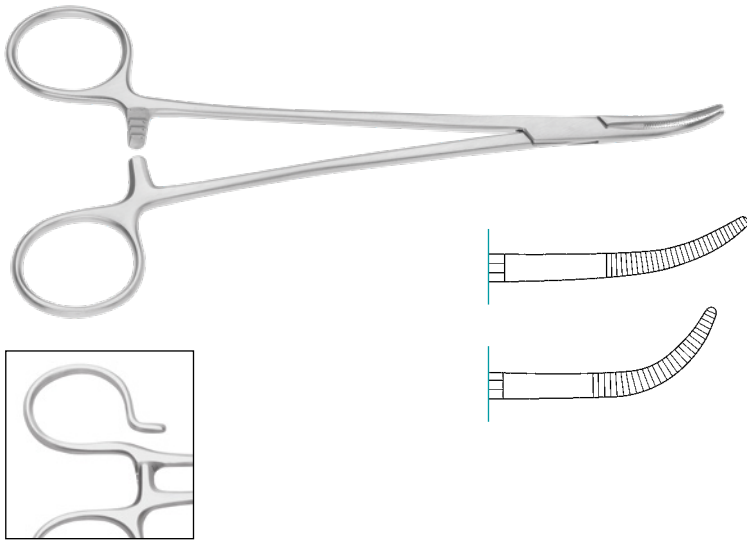

SCHNIDT SAWTELL

Tonsil Seizing Forceps, slightly curved

190mm, 7^{1/2}" 140-628-190

strongly curved

190mm, 7^{1/2}" 140-629-190

slightly curved, with one open ring

190mm, 7^{1/2}" 140-630-190

strongly curved, with one open ring

190mm, 7^{1/2}" 140-631-190

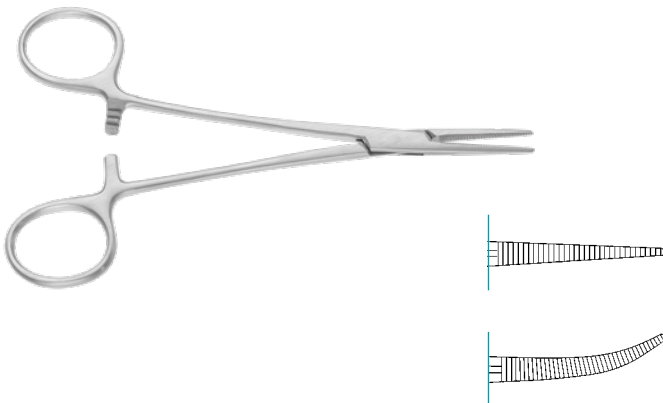

HALSTEAD MOSQUITO

Hemostatic Forceps, serrated, 180mm, 7"

straight 140-254-180

curved 140-255-180

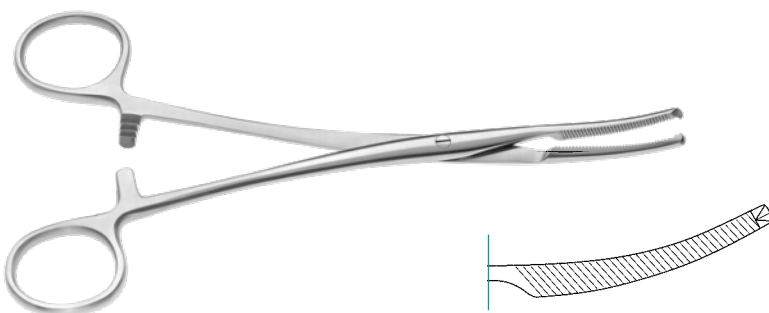

MIKULICZ

Peritoneal Forceps, curved, 1x2 teeth

180mm, 7" 140-548-180

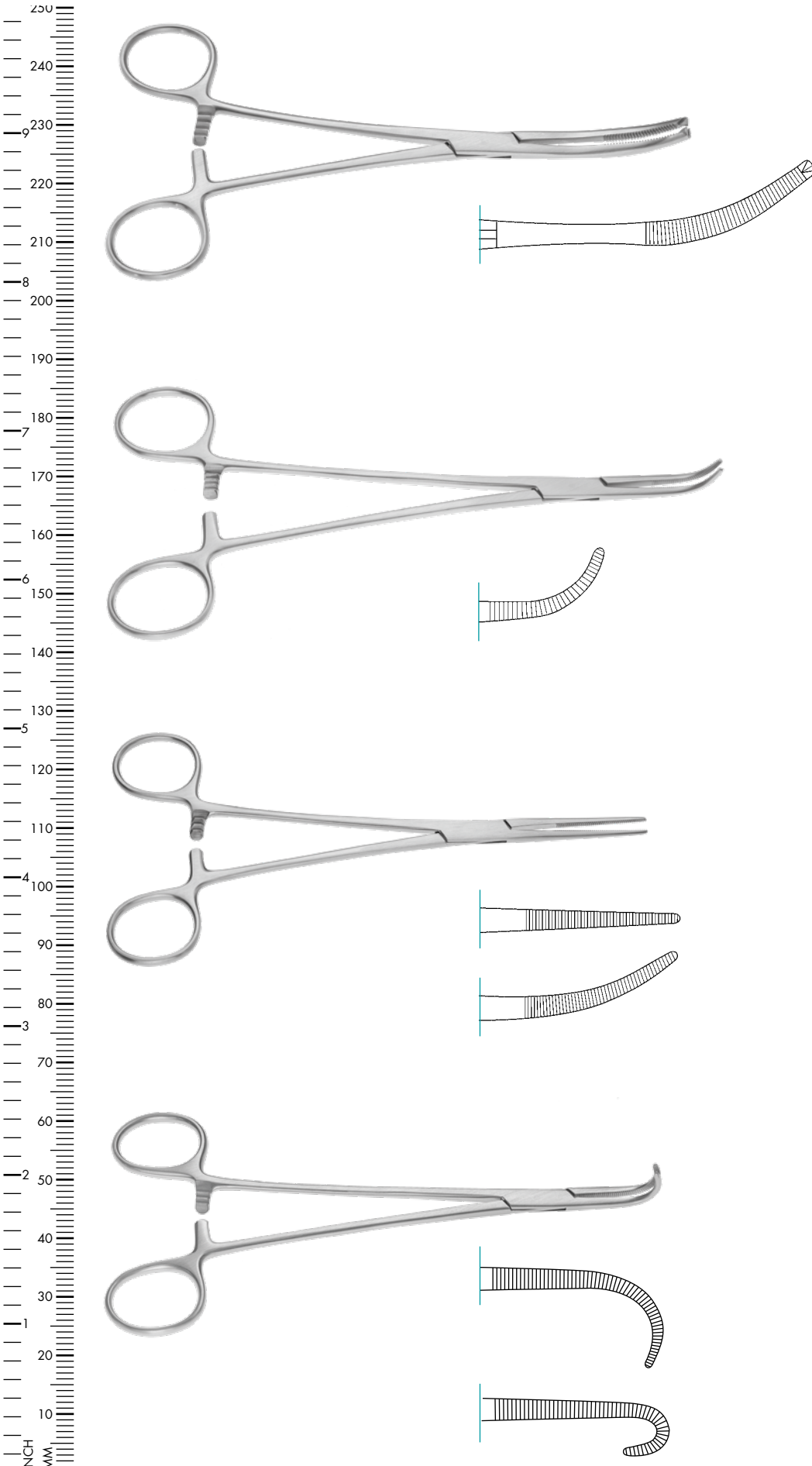

MIKULICZ

Peritoneal Forceps, strongly curved, 1x2 teeth
200mm, 8" 140-549-200

OVERHOLT

Dissecting and Ligature Forceps,
fully serrated, curved
Fig. 0, 195mm, 7^{3/4}" 140-443-001

BIRKETT

Hemostatic Forceps, serrated, 185mm, 7^{1/4}"
straight 140-368-185
curved 140-369-185

NEGUS

Tonsil Artery Forceps, serrated, 190mm, 7^{1/2}"
slightly curved 140-625-190
strongly curved 140-627-190

**BRUENINGS**

Tonsil Snare

270mm, 10²/₃"

430-605-270

**EVES**

Tonsil Snare with ratchet

285mm, 11¹/₄"

430-604-280

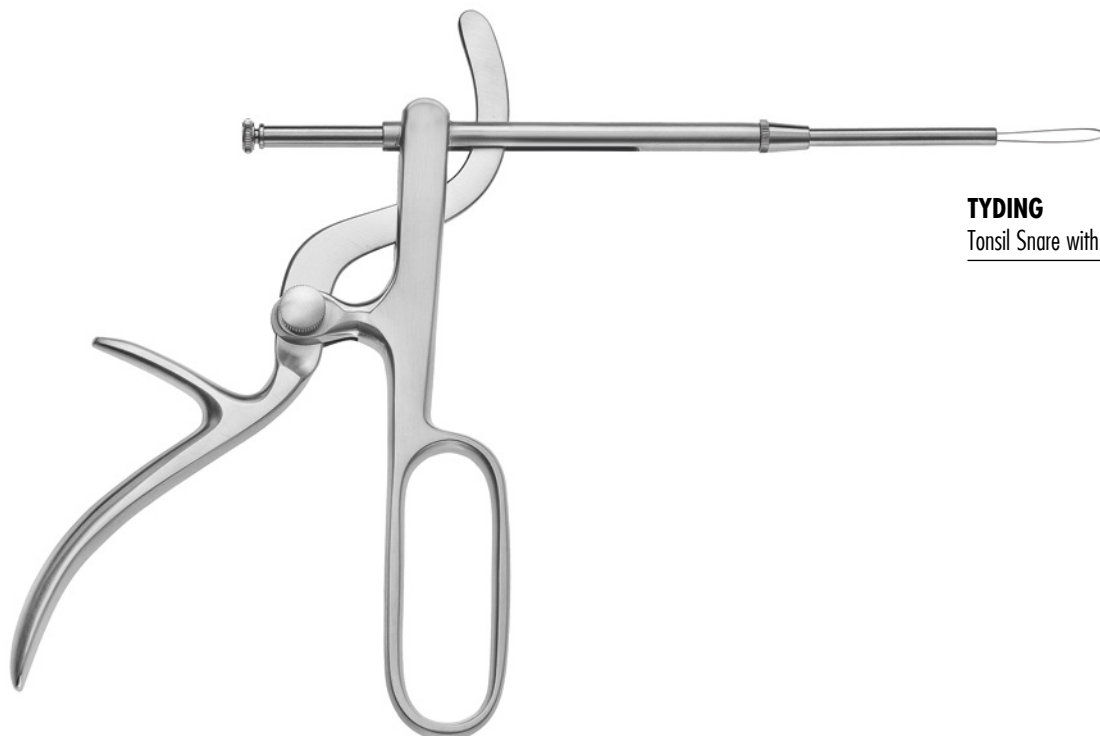
**TYDING**

Tonsil Snare with detachable straight tip

430-620-000

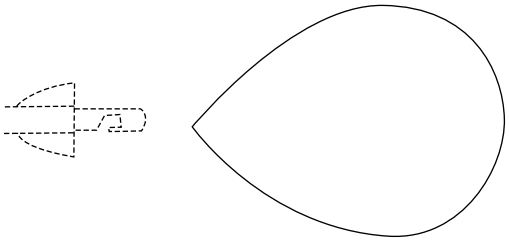
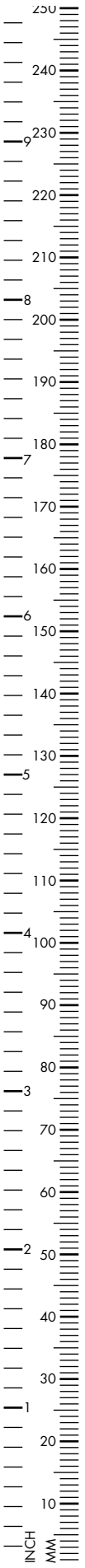

Wire Loop, package of 100 pieces	
Ø 0.4mm x 40mm	430-606-040
Ø 0.4mm x 50mm	430-607-040



Wire Cutting Scissors, serrated, 120mm, 4 ^{3/4} "	
	120-265-120
TC	120-565-120

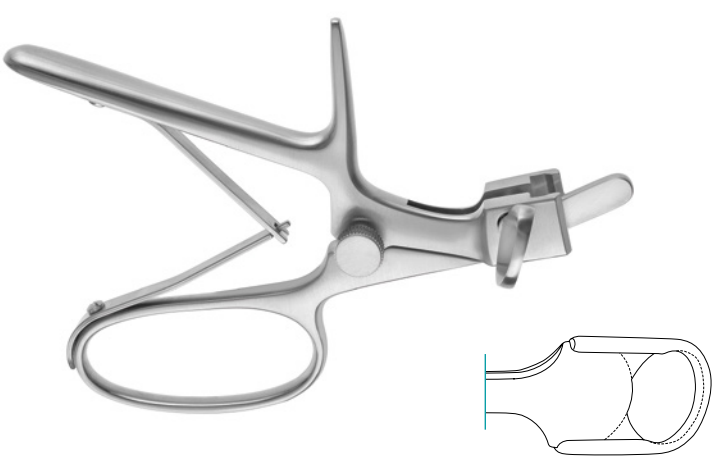

SLUDER-BALLENGER	
Tonsillotome Handle for blades 430-650-001 - 430-650-003	
	430-650-100
Blades	
Fig. 1	430-650-001
Fig. 2	430-650-002
Fig. 3	430-650-003

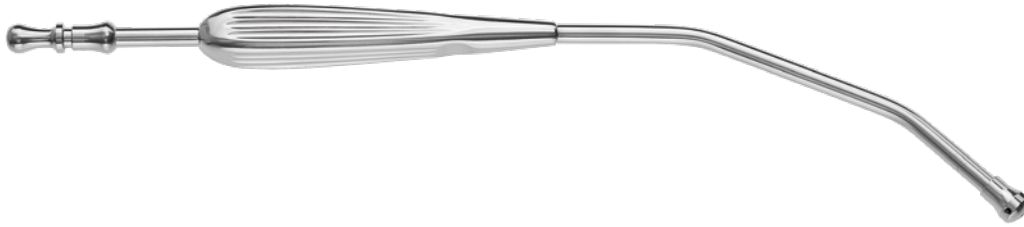
**YANKAUER**

Suction Tube

270mm, 10^{7/8}"

165-543-270

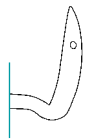
**HURD**Ligature Needle, 210mm, 8^{1/4}"

right 180-719-210

left 180-718-210

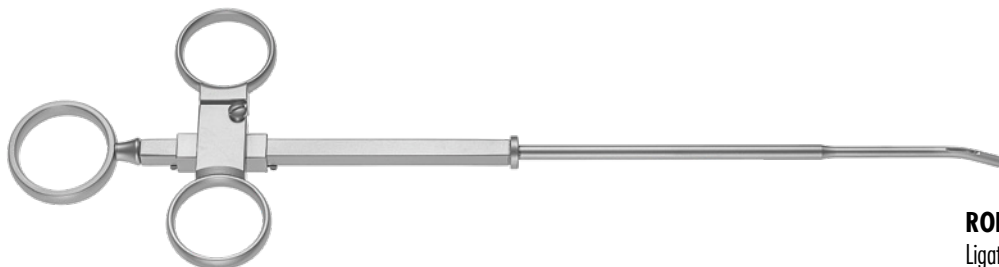
**ROEDER**

Ligature Instrument

260mm, 10^{1/4}"

430-500-260

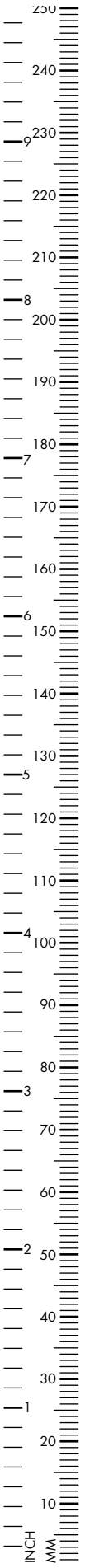

NEGUS

Knot Tier

205mm, 8¹/₈"

430-505-205



LUNIATSCHEK

Gauze Packer, 2mm

190mm, 7¹/₂"

430-602-175

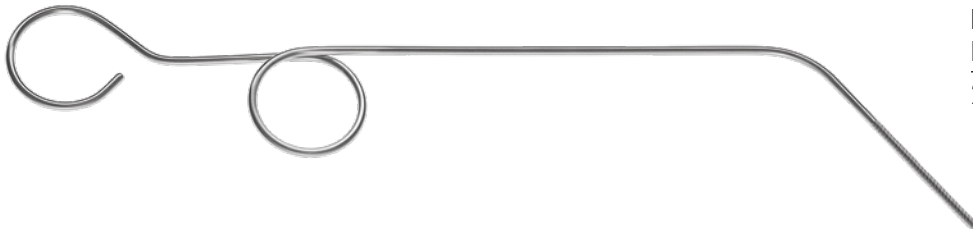

HARTMANN

Postnasal Applicator, spiral end, Ø 2.3mm

220mm, 8²/₃"

160-481-200

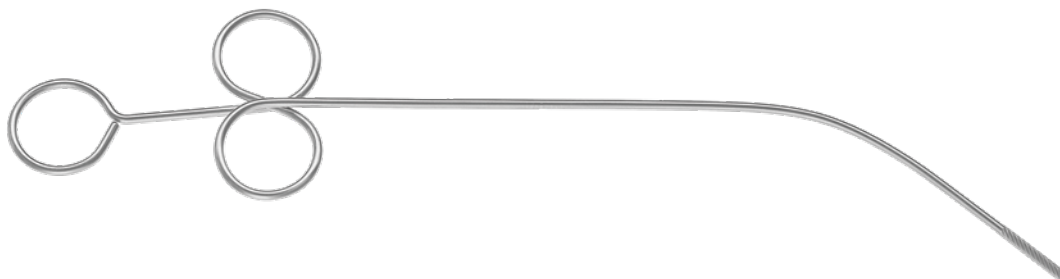

FEIN

Postnasal Applicator

280mm, 11"

160-495-280



Laryngeal Mirror, hexagonal handle,
180mm, 7"

∅ 18mm, Fig. 4	230-330-018
∅ 16mm, Fig. 3	230-330-016
∅ 14mm, Fig. 2	230-330-014
∅ 12mm, Fig. 1	230-330-012
∅ 10mm, Fig. 0	230-330-010
∅ 8mm, Fig. 00	230-330-008
∅ 6mm, Fig. 000	230-330-006
∅ 30mm, Fig. 10	230-330-030
∅ 28mm, Fig. 9	230-330-028
∅ 26mm, Fig. 8	230-330-026
∅ 24mm, Fig. 7	230-330-024
∅ 22mm, Fig. 6	230-330-022
∅ 20mm, Fig. 5	230-330-020



Laryngeal mirror, insert only,
120mm, 4³/₄"

∅ 18mm, Fig. 4	230-329-018
∅ 16mm, Fig. 3	230-329-016
∅ 14mm, Fig. 2	230-329-014
∅ 12mm, Fig. 1	230-329-012
∅ 10mm, Fig. 0	230-329-010
∅ 8mm, Fig. 00	230-329-008
∅ 6mm, Fig. 000	230-329-006
∅ 30mm, Fig. 10	230-329-030
∅ 28mm, Fig. 9	230-329-028
∅ 26mm, Fig. 8	230-329-026
∅ 24mm, Fig. 7	230-329-024
∅ 22mm, Fig. 6	230-329-022
∅ 20mm, Fig. 5	230-329-020



Mirror Handle with set screw

110mm, 4 ¹ / ₃ "	230-331-110
--	-------------

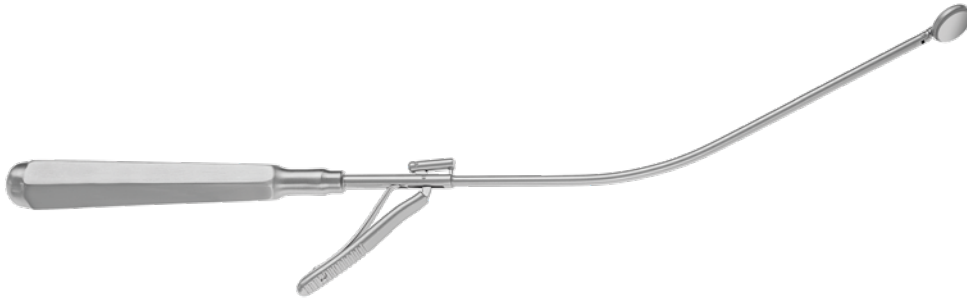
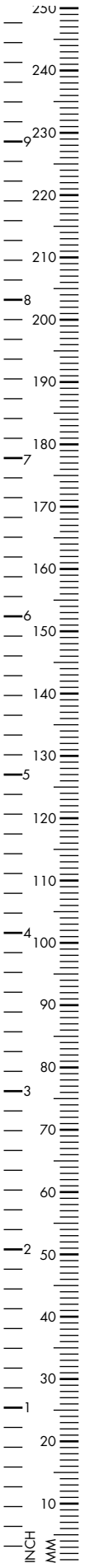

MICHEL

Rhinoscopic mirror with interchangeable mirror inserts, 250mm, 9⁷/₈"

Ø 12mm	430-788-012
Ø 14mm	430-788-014
Ø 16mm	430-788-016
Ø 18mm	430-788-018

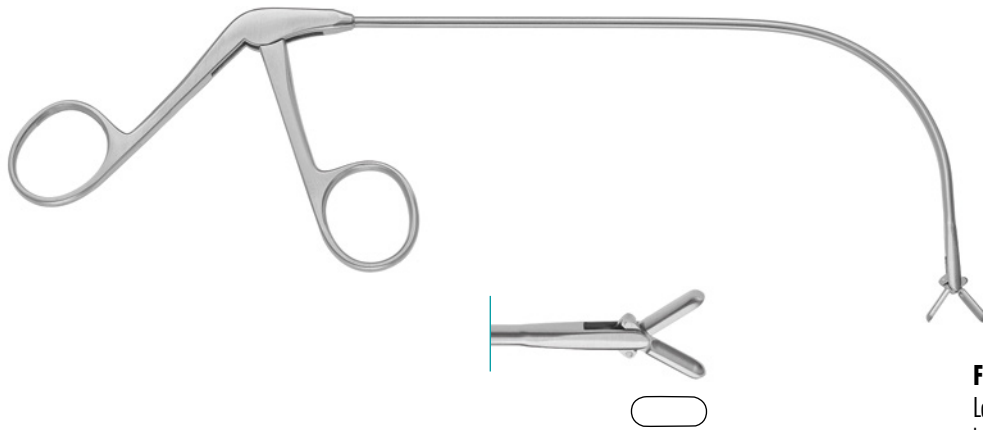

FRAENKEL

Laryngeal Forceps, double action, longitudinal oval jaws

170mm, 6 ² / ₃ "	430-813-050
--	-------------

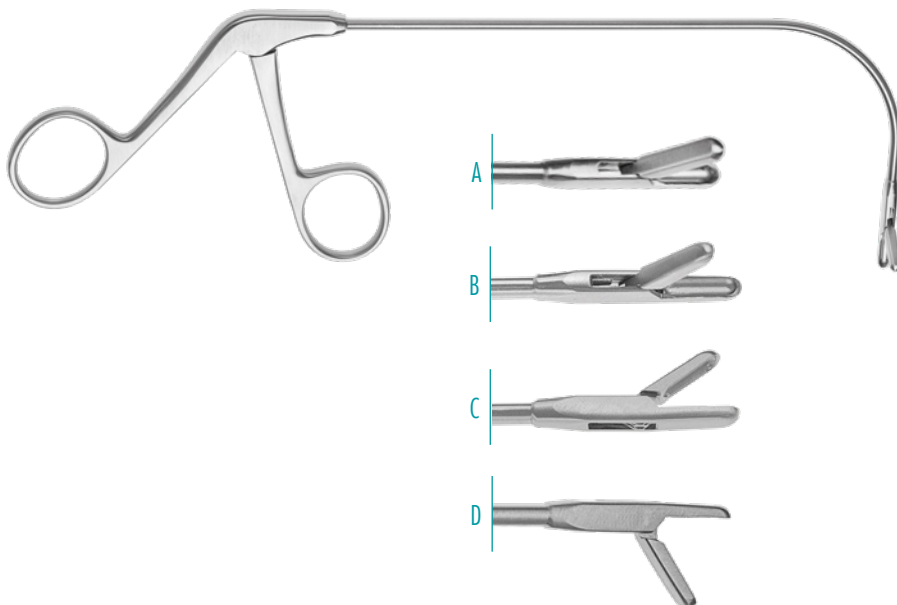

JURASZ

Laryngeal Polypus Forceps, 220mm, 8²/₃"

A opening to right	430-813-010
B opening to left	430-813-020
C opening downwards	430-813-030
D opening upwards	430-813-040

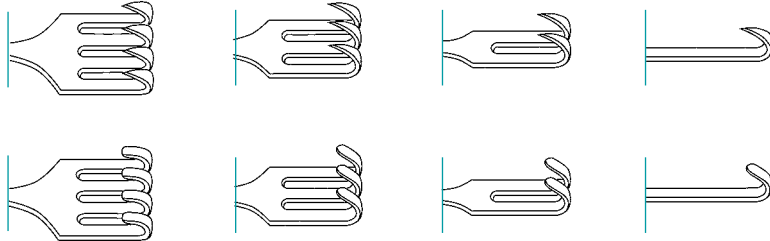

Hand Held Retractor, 160mm, 6¹/₄"
sharp

1 prong	170-074-161
2 prongs	170-074-162
3 prongs	170-074-163
4 prongs	170-074-164

blunt

1 prong	170-075-161
2 prongs	170-075-162
3 prongs	170-075-163
4 prongs	170-075-164

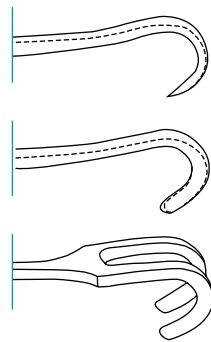

Tracheal Hook, 160mm, 6¹/₄"

sharp	170-005-001
blunt	170-005-002
2 prongs, blunt	170-005-003



LABORDE

Tracheal Dilator

140mm, 5 ¹ / ₂ "	440-130-140
--	-------------

**TROUSSEAU**

Tracheal Dilator

120mm, 4³/₄" 440-120-120140mm, 5¹/₂" 440-120-140**KOCHER**

Goitre Director with hole

160mm, 6¹/₄" 440-221-160

LARYNGOSCOPY



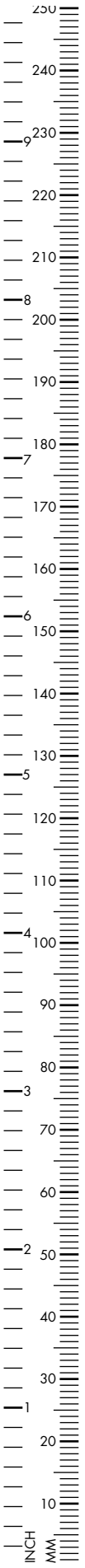

Naso-Pharyngo-Laryngoscope, flexible,
300mm working length

Ø 2.2mm	100-500-220
Ø 2.8mm	100-500-280
Ø 3.2mm	100-500-320
Ø 3.4mm	100-500-340



Naso-Pharyngo-Laryngoscope, flexible,
300mm working length,
with working channel



Ø 2.8mm	100-500-285
Ø 1.2mm working channel	
Ø 3.8mm	100-500-385
Ø 1.4mm working channel	



Laryngoscope, Ø 10mm, 90°
160mm working length

270mm, 10²/₃" 100-800-090

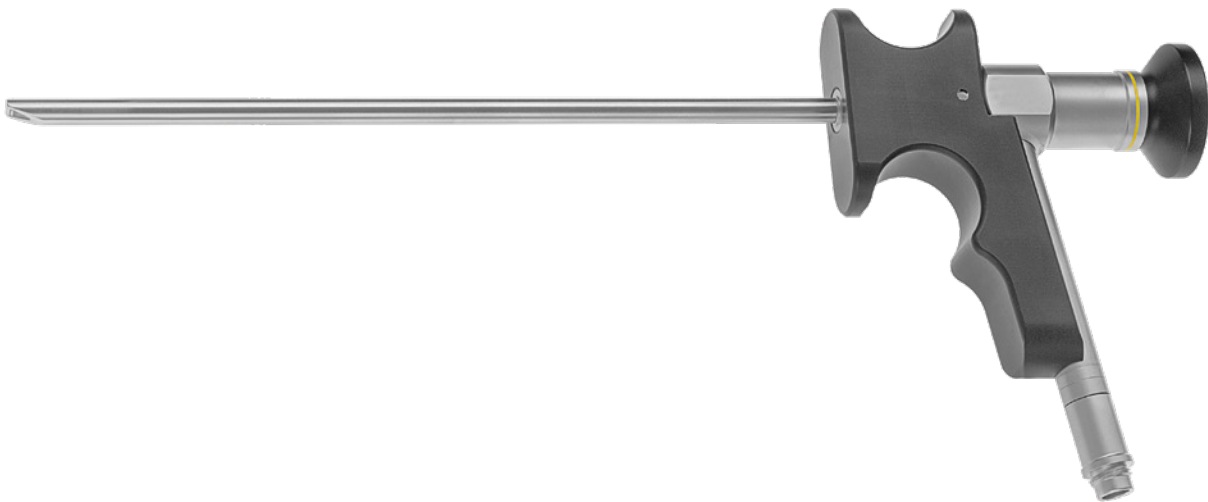

Laryngoscope with handle,
70° angle of view, 190mm, 7¹/₂"

Ø 5mm 100-805-070

Ø 6mm 100-806-070

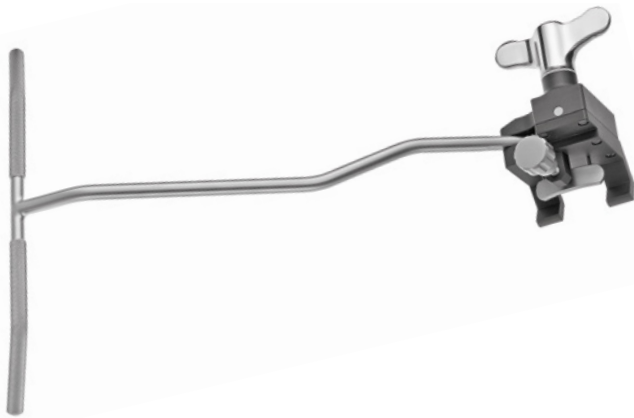
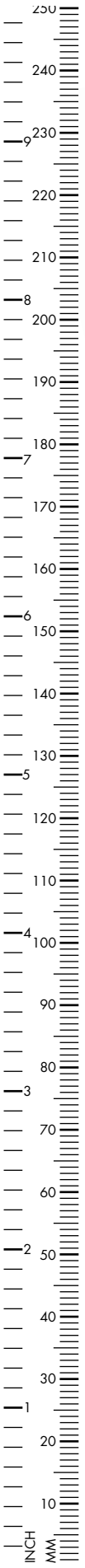

LEWY
Chest Support, for Operating Laryngoscopes
340mm, 13¹/₂" 100-500-102



Laryngoscope Handle, detachable,
for LEWY Chest Support
and Operating Laryngoscopes
100-512-000



Chest Support, complete,
for Operating Laryngoscopes
Ø95mm / Adult 100-500-100
Ø95mm / Children 100-500-101



Support Rod, with ring
340mm, 13¹/₂" 100-500-113
240mm, 9¹/₂" 100-500-111



Joint for Chest Support
100-500-110



Supporting Table for Chest Support,
complete set

100-500-150

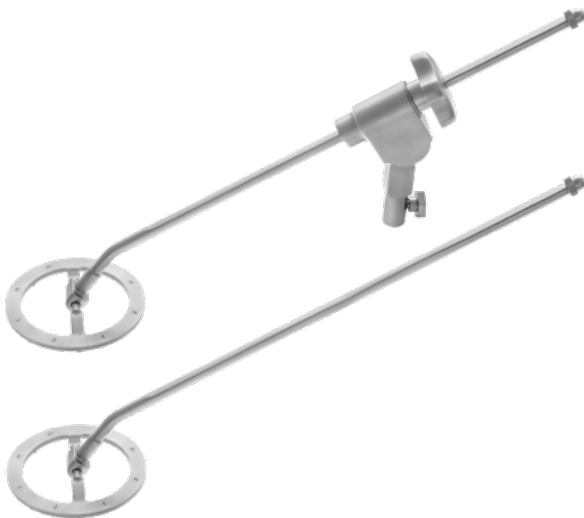

Chest Support, complete,
for Operating Laryngoscopes

Ø90mm 100-500-200

Support Rod

340mm, 13¹/₂" 100-500-210

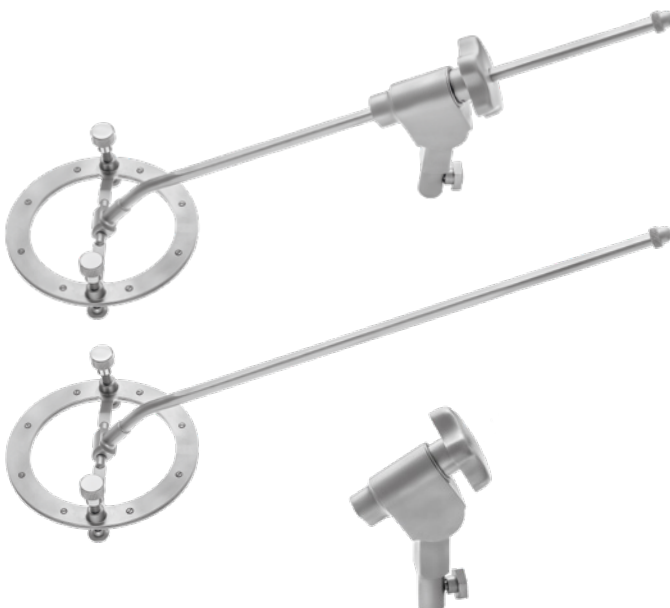

Chest Support, complete,
for Operating Laryngoscopes

Ø120mm 100-500-400

Support Rod

340mm, 13¹/₂" 100-500-410

Joint for Chest Support

100-500-420

**HOLINGER**

Laryngoscope, complete with light carrier

small, Newborn, 90mm, 3 ¹ / ₂ "	100-510-000
--	-------------

small, Babies, 120mm, 4 ³ / ₄ "	100-510-001
--	-------------

large, Children, 170mm, 6 ² / ₃ "	100-510-002
--	-------------

large, Adult, 180mm, 7"	100-510-003
----------------------------	-------------

spare light carrier	
---------------------	--

Newborn	100-510-100
---------	-------------

Babies	100-510-101
--------	-------------

Children	100-510-102
----------	-------------

Adult	100-510-103
-------	-------------

**JACKSON**

Laryngoscope, complete with light carrier

small, Newborn, 90mm, 3 ¹ / ₂ "	100-505-000
--	-------------

small, Babies, 125mm, 8"	100-505-001
-----------------------------	-------------

large, Children, 170mm, 6 ² / ₃ "	100-505-002
--	-------------

large, Adult, 180mm, 7"	100-505-003
----------------------------	-------------

spare light carrier	
---------------------	--

Newborn	100-505-100
---------	-------------

Babies	100-505-101
--------	-------------

Children	100-505-102
----------	-------------

Adult	100-505-103
-------	-------------

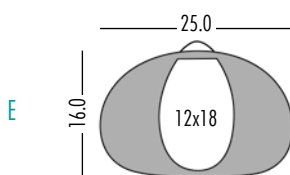
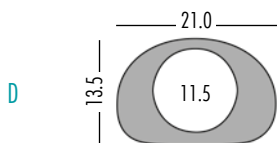
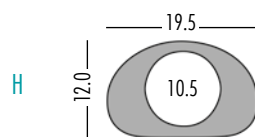
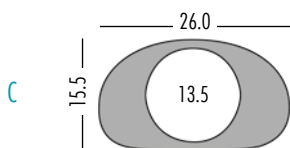
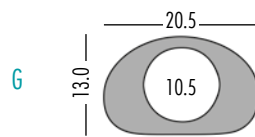
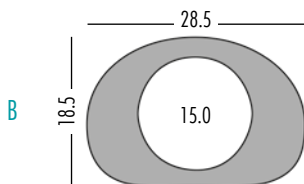
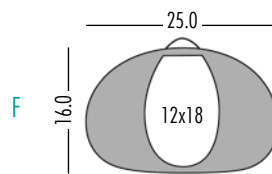
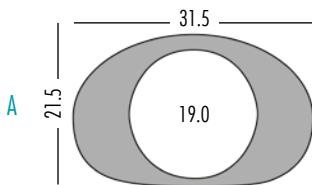
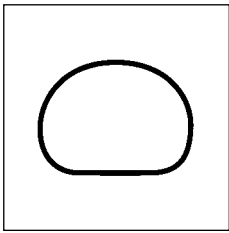

KLEINSASSER

Operation Laryngoscope

A extra large, Adults, 170mm, 6 ² / ₃ "	100-500-008
B extra large, Adults, 170mm, 6 ² / ₃ "	100-500-005
C medium, Adults, 170mm, 6 ² / ₃ "	100-500-004
D small, Adults, 180mm, 7"	100-500-003
E medium, anterior Adults, 170mm, 6 ² / ₃ "	100-500-006
F medium, long neck, Adults 220mm, 8 ² / ₃ "	100-500-007
G small, Children, 150mm, 6"	100-500-002
H small, Infants, 130mm, 5"	100-500-001

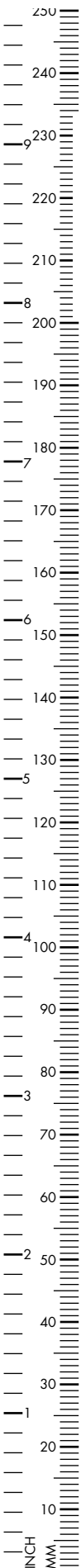

Fiber Optic Light Carrier
for
100-500-001/100-500-002
100-500-201/100-500-202

75mm, 3" 100-500-019

for
100-500-003 - 100-500-008
100-500-203 - 100-500-208

140mm, 5^{1/2}" 100-500-020



Fiber Optic Light Carrier, large
for
100-500-007 & 100-500-207

100-500-021



Suction Tube, \varnothing 3mm
for
100-500-001/100-500-002

90mm, 3^{1/2}" 100-500-080

for
100-500-003/100-500-008

125mm, 5" 100-500-075



Injection Cannula
for
100-500-001 - 100-500-008
100-500-201 - 100-500-208

85mm, 3^{1/4}" 100-500-050

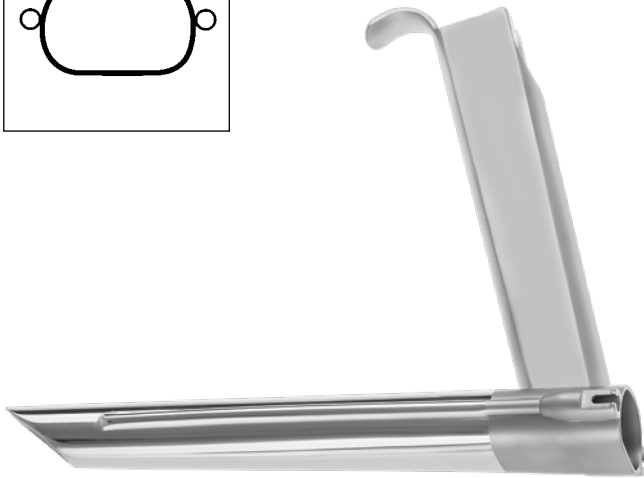
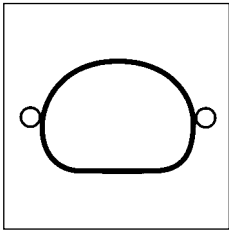

KLEINSASSER-LASER

Operation Laryngoscope

A extra large, Adults, 170mm, 6 ² / ₃ "	100-500-537
B extra large, Adults, 170mm, 6 ² / ₃ "	100-500-536
C medium, Adults, 170mm, 6 ² / ₃ "	100-500-535
D small, Adults, 180mm, 7"	100-500-534
E medium, anterior Adults, 170mm, 6 ² / ₃ "	100-500-533
F small, Children, 150mm, 6"	100-500-532
G small, Infants, 130mm, 5"	100-500-531

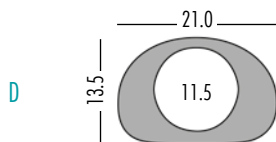
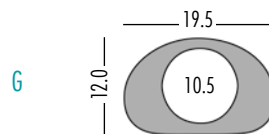
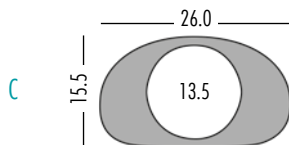
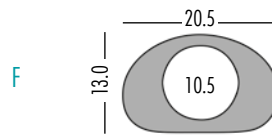
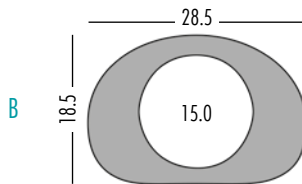
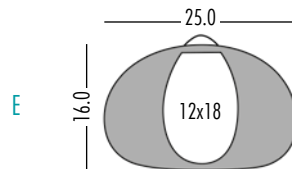
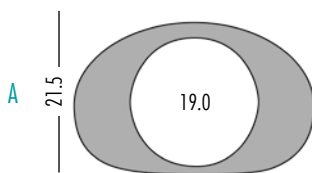

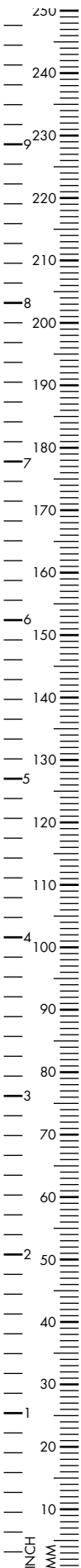

Fiber Optic Light Carrier
for
100-500-562 / 100-500-564

120mm, 4 ^{3/4} "	100-500-538
---------------------------	-------------



Fiber Optic Light Carrier
for
100-500-532

140mm, 5 ^{1/2} "	100-500-539
---------------------------	-------------

for
100-500-533 - 100-500-537

140mm, 5 ^{1/2} "	100-500-540
---------------------------	-------------



Suction Tube
for
100-500-531

120mm, 4 ^{3/4} "	100-500-541
---------------------------	-------------

for
100-500-532

140mm, 5 ^{1/2} "	100-500-532
---------------------------	-------------

for
100-500-533 - 100-500-537

160mm, 6 ^{1/4} "	100-500-543
---------------------------	-------------



KLEINSASSER, B-L.

Operation Laryngoscope

A Children 115mm, 4 ¹ / ₂ "	100-500-552
B Infants 95mm, 3 ³ / ₄ "	100-500-551

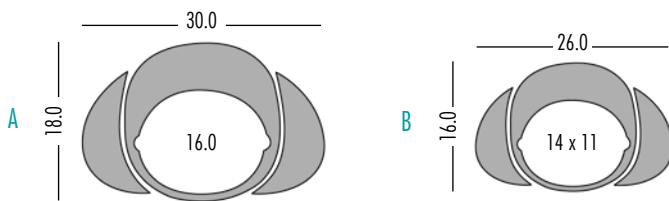

Fiber Optic Light Carrier
for
100-500-563

65mm, 2 ¹ / ₂ "	100-500-556
---------------------------------------	-------------



Suction Tube
for
100-500-552 / 100-500-551

65mm, 2 ¹ / ₂ "	100-500-558
---------------------------------------	-------------



KLEINSASSER, L.

Operation Laryngoscope

A large, Adults 150mm, 6"	100-500-555
B large, Adults 170mm, 6 ² / ₃ "	100-500-554
C small, Children 110mm, 4 ¹ / ₃ "	100-500-553

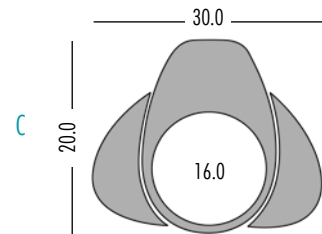
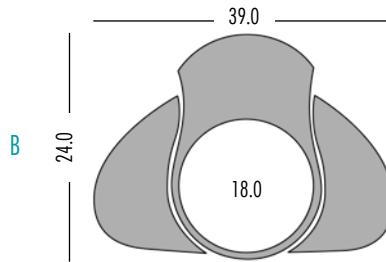
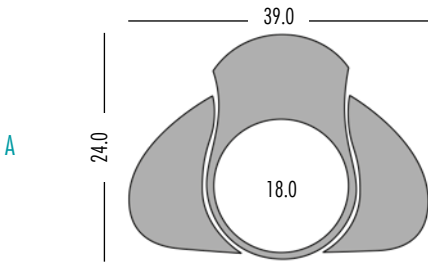

Fiber Optic Light Carrier
for

100-500-553 - 100-500-555

75mm, 3"	100-500-557
----------	-------------



Suction Tube
for

100-500-553

70mm, 2 ³ / ₄ "	100-500-559
---------------------------------------	-------------

for

100-500-555 / 100-500-554

85mm, 3 ¹ / ₄ "	100-500-560
---------------------------------------	-------------



Injection Cannula
for

100-500-553 - 100-500-555

85mm, 3 ¹ / ₄ "	100-500-561
---------------------------------------	-------------

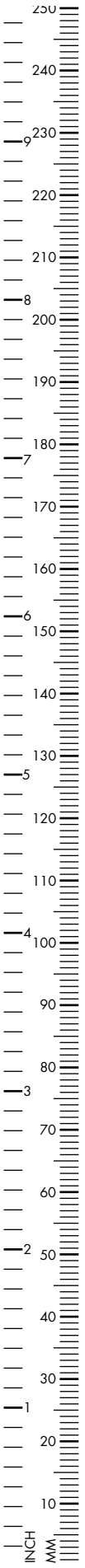

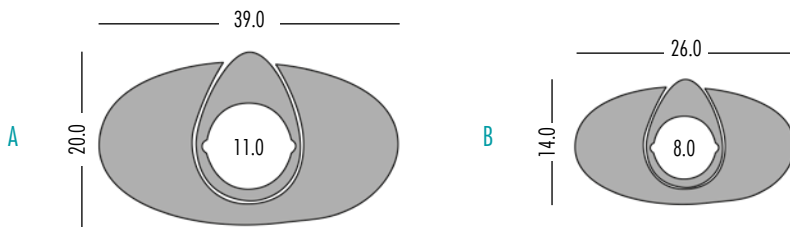

KLEINSASSER, B.

Operation Laryngoscope

A medium, Children 100-500-564
150mm, 6"

B small, Children 100-500-563
115mm, 4 1/2"

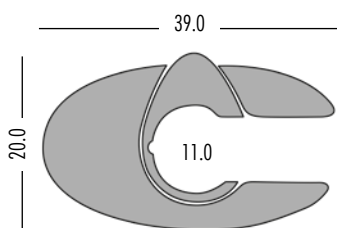

KLEINSASSER, B. - P

Operation Laryngoscope

medium, Children 100-500-562
150mm, 6"

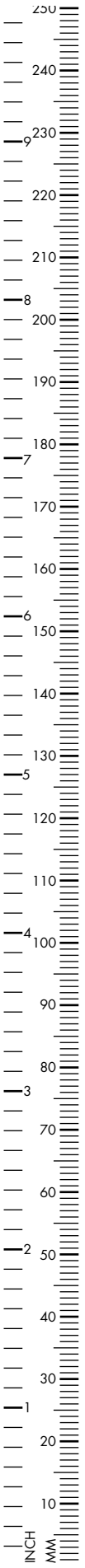

Fiber Optic Light Carrier
for
100-500-562 / 100-500-564

120mm, 4^{3/4}" 100-500-538

for
100-500-563

65mm, 2^{1/2}" 100-500-556



Fiber Optic Light Carrier
for
100-500-531

120mm, 4^{3/4}" 100-500-541



Suction Tube
for
100-500-552 / 100-500-551

65mm, 2^{1/2}" 100-500-558



Light Clip

100-500-576



Injection Cannula, malleable,
135mm, 5^{1/3}"

Ø 2mm 100-500-574

Ø 3mm 100-500-575

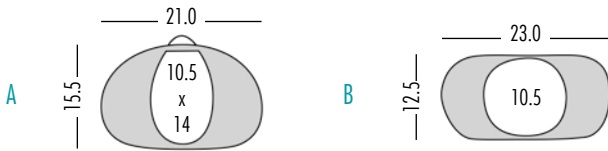

KLEINSASSER, B. - S.

Operation Laryngoscope

A slender, Adult 100-500-573
170mm, 6²/₃"

B extra - slender, Adult 100-500-572
150mm, 6"

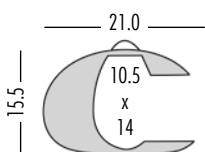

KLEINSASSER, B. - P. - S.

Operation Laryngoscope

slender, Adult 100-500-571
170mm, 6²/₃"

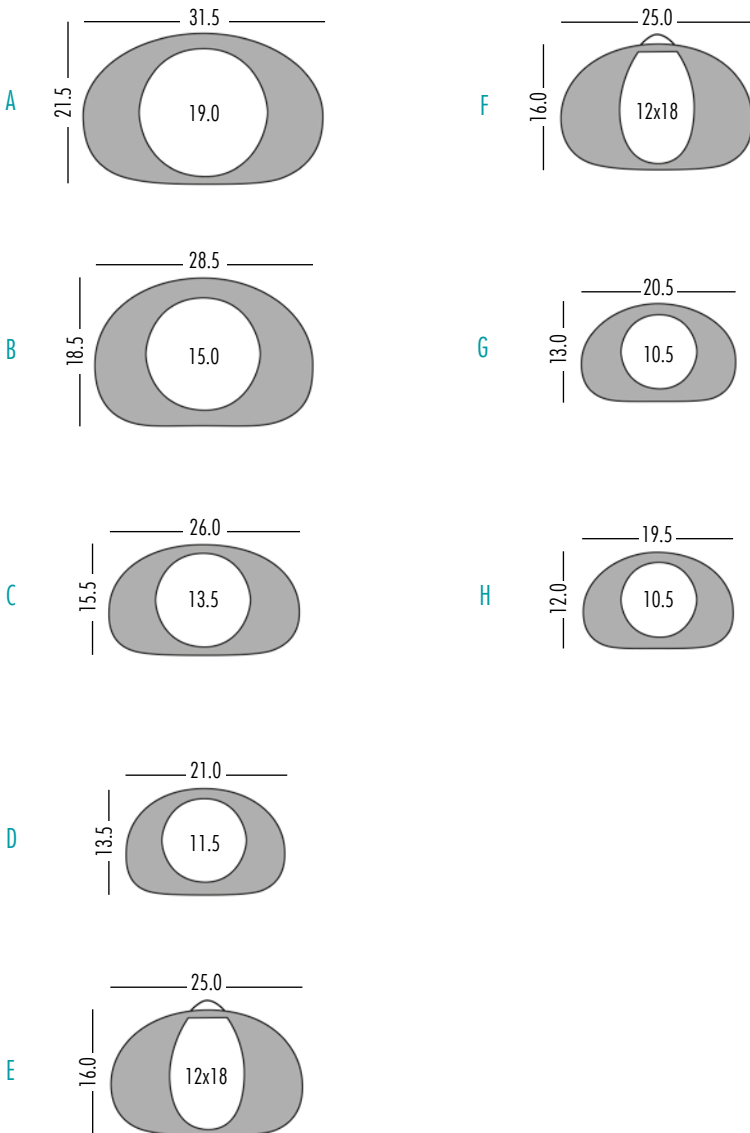

Operation Laryngoscope, spreadable

A extra large, Adults, 170mm, 6 ² / ₃ "	100-500-208
B extra large, Adults, 170mm, 6 ² / ₃ "	100-500-205
C medium, Adults, 170mm, 6 ² / ₃ "	100-500-204
D small, Adults, 180mm, 7"	100-500-203
E medium, anterior Adults, 180mm, 7"	100-500-206
F medium, long neck Adults, 220mm, 8 ² / ₃ "	100-500-207
G small, Children, 150mm, 6"	100-500-202
H small, Infants, 130mm, 5"	100-500-201



Fiber Optic Light Carrier
for
100-500-001/100-500-002
100-500-201/100-500-202

75mm, 3" 100-500-019

for
100-500-003 - 100-500-008
100-500-203 - 100-500-208

140mm, 5¹/₂" 100-500-020



Suction Tube, \varnothing 3mm
for
100-500-001/100-500-002

90mm, 3¹/₂" 100-500-080

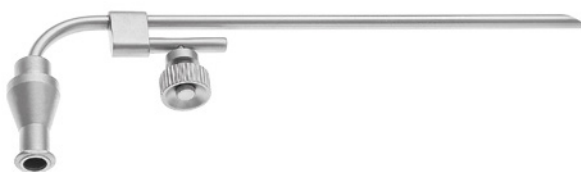

Injection Cannula
for
100-500-001 - 100-500-008
100-500-201 - 100-500-208

85mm, 3¹/₄" 100-500-050



Operation Laryngoscope, spreadable

A extra large, Adults, 180mm, 7"	100-500-583
B Adolescent / Adults, 180mm, 7"	100-500-582
C small, Children, 135mm, 5 ¹ / ₃ "	100-500-581

PROXIMAL

DISTAL

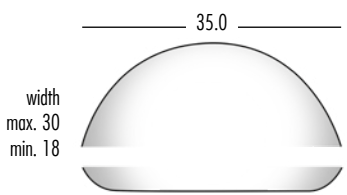

A

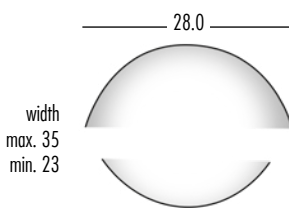
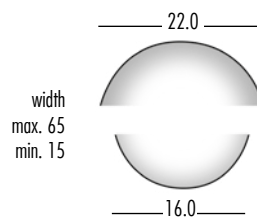

B

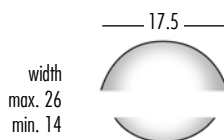
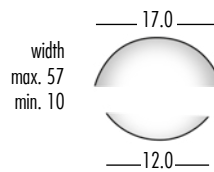

C

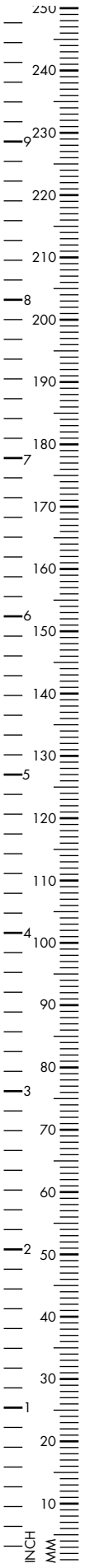
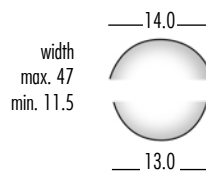



Fiber Optic Light Carrier
for
100-500-583 / 100-500-582

120mm, 4^{3/4}" 100-500-584

for
100-500-581

100mm, 4" 100-500-585



Suction Tube
for
100-500-583 / 100-500-582

100mm, 4" 100-500-586

for
100-500-581

120mm, 4^{3/4}" 100-500-587



Injection Cannula
for
100-500-583 / 100-500-582

70mm, 2^{3/4}" 100-500-588

Cupped Forceps

Round cupped, jaws, conical tubular shaft,
working length: 230mm, 9"



straight

2mm	100-700-001
4mm	100-700-101

curved upwards

2mm	100-700-002
4mm	100-700-102

curved left

2mm	100-700-003
4mm	100-700-103

curved right

2mm	100-700-004
4mm	100-700-104

curved upwards right

2mm	100-700-005
-----	-------------

curved upwards left

2mm	100-700-006
-----	-------------

horizontal curved right opening

2mm	100-700-007
-----	-------------

horizontal curved left opening

2mm	100-700-008
-----	-------------

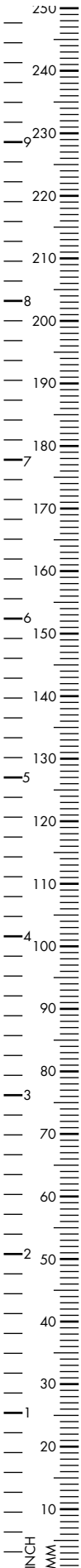

Alligator Forceps

conical tubular shaft, 2mm,
working length: 230mm, 9"



straight

100-700-020



curved right

100-700-021



curved left

100-700-022



curved upwards

100-700-023



triangular jaws, curved upwards right

100-700-024



triangular jaws, curved upwards left

100-700-025



triangular jaws, straight

100-700-026

Micro Laryngeal Scissors

conical tubular shaft, 2mm,
working length: 230mm, 9"

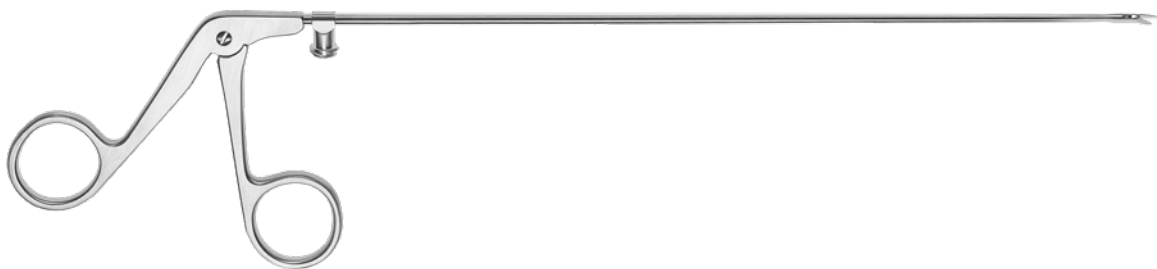

straight

100-700-050



45° upcurved

100-700-051



curved right

100-700-052



curved left

100-700-053



straight, horizontal cutting

100-700-054

Laryngeal Instruments

distal end angled up, conical tubular shaft,
working length: 230mm, 9"

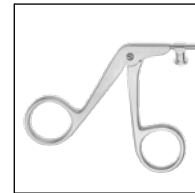
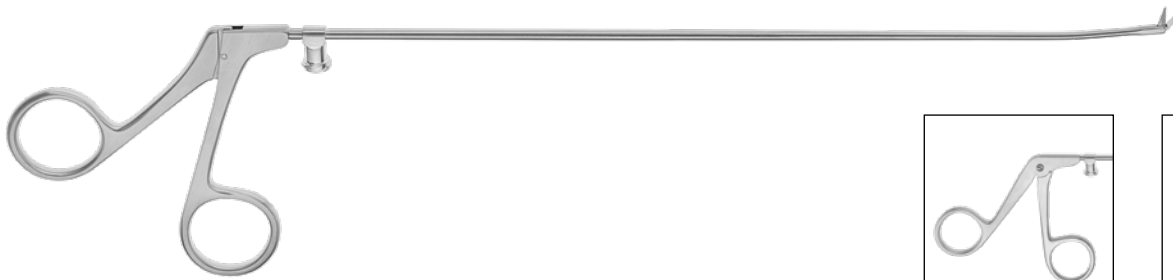

Regular Handle



Handle with thumb control



straight

100-715-001

with thumb control

100-725-001



curved upwards

100-715-002

with thumb control

100-725-002



curved right

100-715-003

with thumb control

100-725-003



curved left

100-715-004

with thumb control

100-725-004



Scissors, straight

100-715-005

with thumb control

100-725-005



Scissors, 45° curved upwards

100-715-006

with thumb control

100-725-006



Scissors, curved right

100-715-007

with thumb control

100-725-007



Scissors, curved left

100-715-008

with thumb control

100-725-008

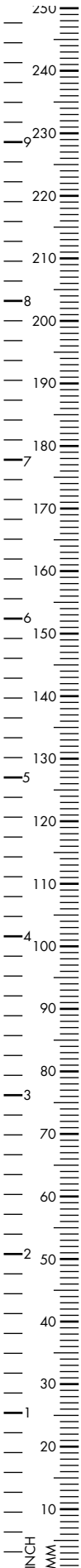

Laryngeal Instruments, 360° rotatable

with LuerLock, working length: 235mm, 9¹/₄"

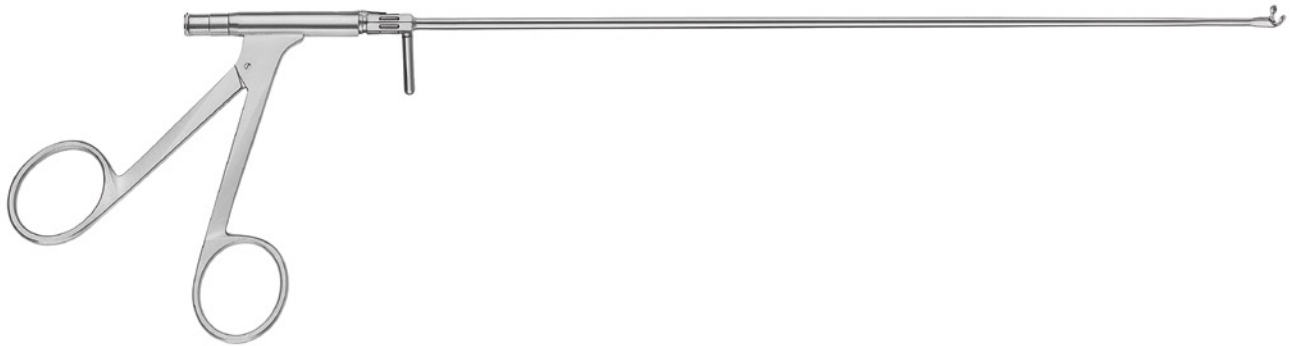

straight

2mm 100-700-501

1mm 100-700-511



curved upwards

2mm 100-700-502

1mm 100-700-512



curved right

2mm 100-700-503

1mm 100-700-513



curved left

2mm 100-700-504

1mm 100-700-514



straight

100-700-520



curved upwards

100-700-523



curved right

100-700-521



curved upwards

100-700-524



curved left

100-700-522



straight

100-700-550



curved upwards

100-700-551



curved right

100-700-552



curved left

100-700-553

Mini Laryngeal Instruments

conical tubular shaft, working length: 230mm, 9"



straight
1mm 100-710-001

curved upwards
1mm 100-710-002

curved right
1mm 100-710-003

curved left
1mm 100-710-004

curved upwards right
1mm 100-710-005

curved upwards left
1mm 100-710-006

straight
100-710-020

curved right
100-710-021

curved left
100-710-022

curved upwards
100-710-023

curved upwards right
100-710-024

curved upwards left
100-710-025

straight
100-710-050

angled 45°
100-710-051

curved right
100-710-052

curved left
100-710-053

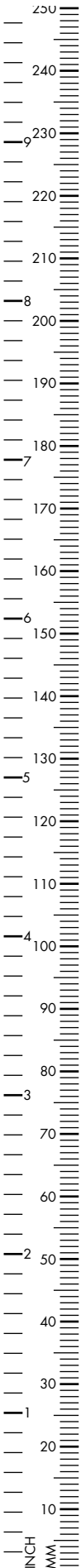

KLEINSASSER

Pediatric Laryngeal Instruments

conical tubular shaft, working length: 180mm, 7"

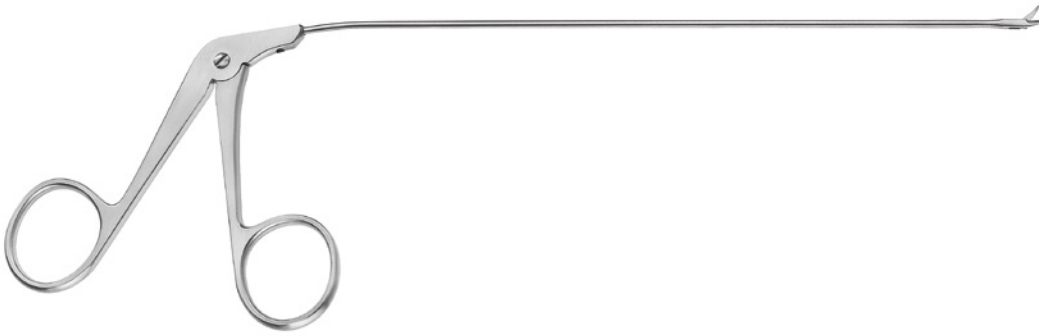

straight

2mm 100-712-001
3mm 100-712-002



curved upwards

2mm 100-712-003
3mm 100-712-004



straight

100-712-005



curved upwards

100-712-013



straight

100-712-006



45° angled

100-712-007



curved right

100-712-008



curved left

100-712-009

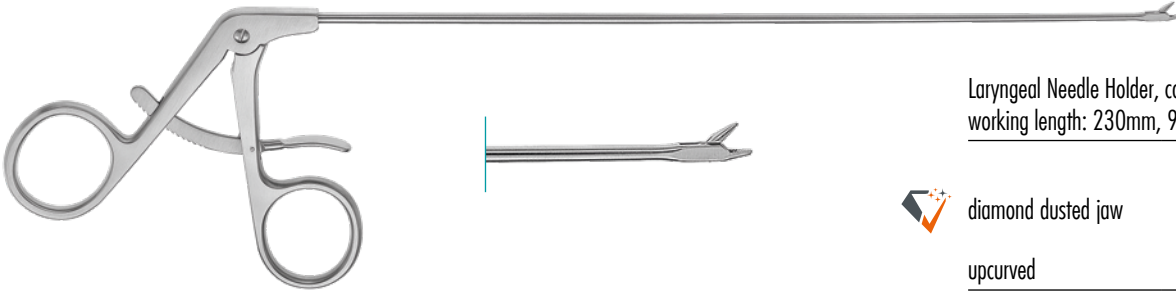
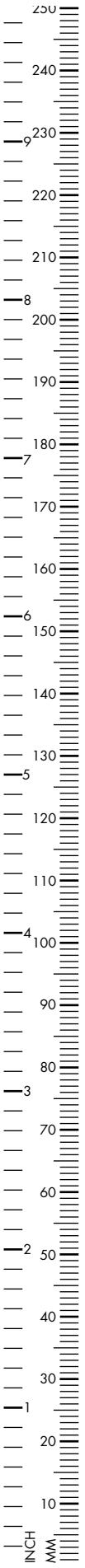

Laryngeal Needle Holder, conical tubular shaft,
working length: 230mm, 9"

	100-700-200
 diamond dusted jaw	100-700-210
upcurved	100-700-230

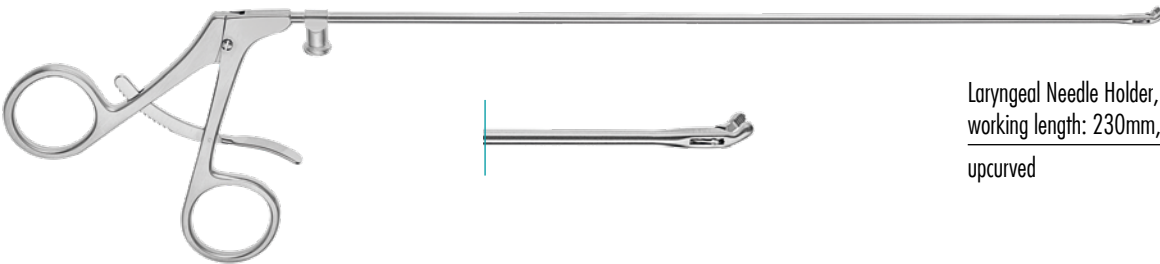

Laryngeal Needle Holder, conical tubular shaft,
working length: 230mm, 9"

upcurved	100-700-230
----------	-------------

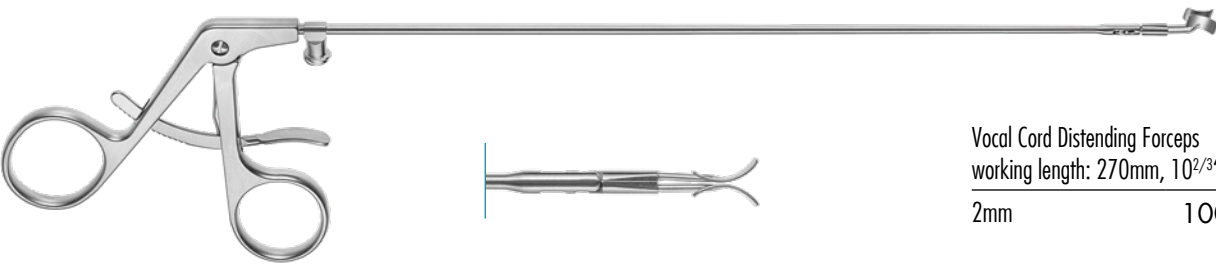

Vocal Cord Distending Forceps
working length: 270mm, 10²/₃"

2mm	100-700-270
-----	-------------

Laryngeal Instruments for Microsurgery

total length: 250mm, 9^{7/8"}



Knife, round, 45° angled

Ø 2.5mm 100-850-001



Knife, round, vertical cutting

100-850-002



Knife, oval, straight

100-850-003



Knife, sickle shaped

100-850-004



Knife, golfstick-shaped

100-850-005



Hook, with probe end blunt

100-850-006



Hook sharp

100-850-007



Ligature needle curved right

100-850-008



Ligature Needle curved left

100-850-009



Elevator with suction channel

100-850-010



Knot guide

100-850-011



Hook with probe end 90° angled

100-850-012



Elevator, slightly curved

100-850-013



Elevator, 90° curved

100-850-014



Knife, straight, lance-shaped

100-850-015



100-850-000
Handle only

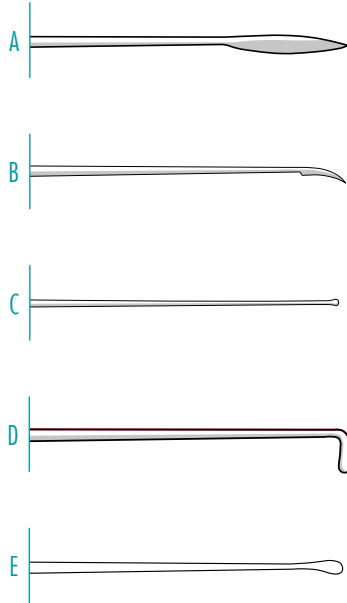
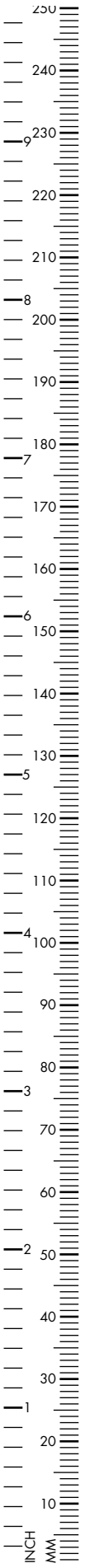

JAKO-TYPE

295mm, 11²/₃"

- | | | |
|---|--|-------------|
| A | Laryngeal Knife,
8mm blade length | 100-853-295 |
| B | Laryngeal
Sickle Knife,
8mm blade length | 100-854-295 |
| C | Laryngeal Probe,
straight | 100-855-300 |
| D | Laryngeal Probe,
90° angled | 100-856-300 |
| A | Micro Dissector
blunt, 4mm wide | 100-857-300 |

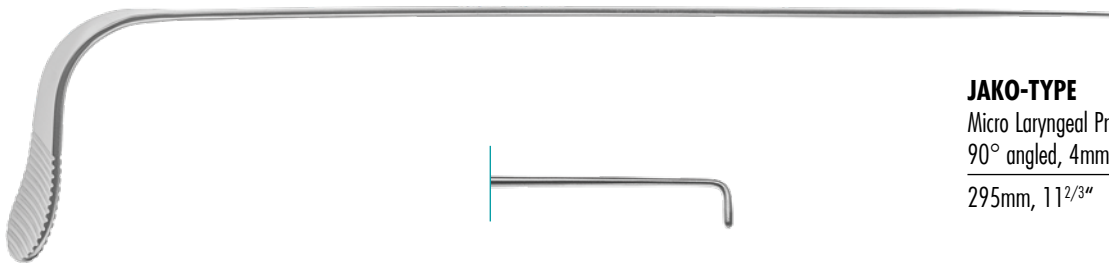

JAKO-TYPE

Micro Laryngeal Probe, thumb handle,
90° angled, 4mm

295mm, 11²/₃" 100-860-300

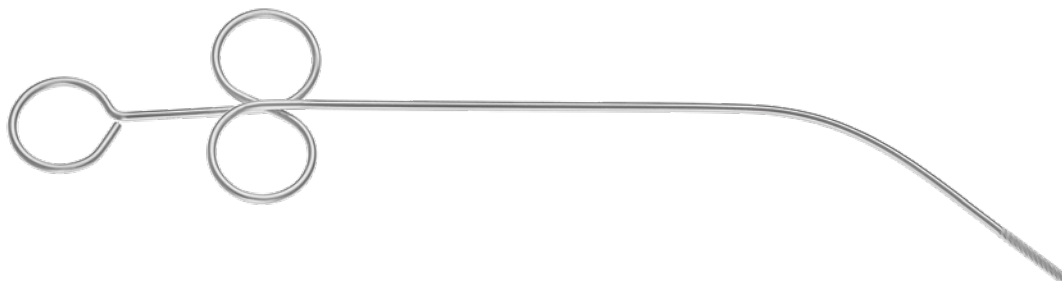

Cotton Applicator, twist end serrated,
Ø 2.3mm

280mm, 11" 100-864-280

Suction Tube, 250mm, 9⁷/₈"

Ø 2.0mm	100-860-020
Ø 2.5mm	100-860-025
Ø 3.0mm	100-860-030

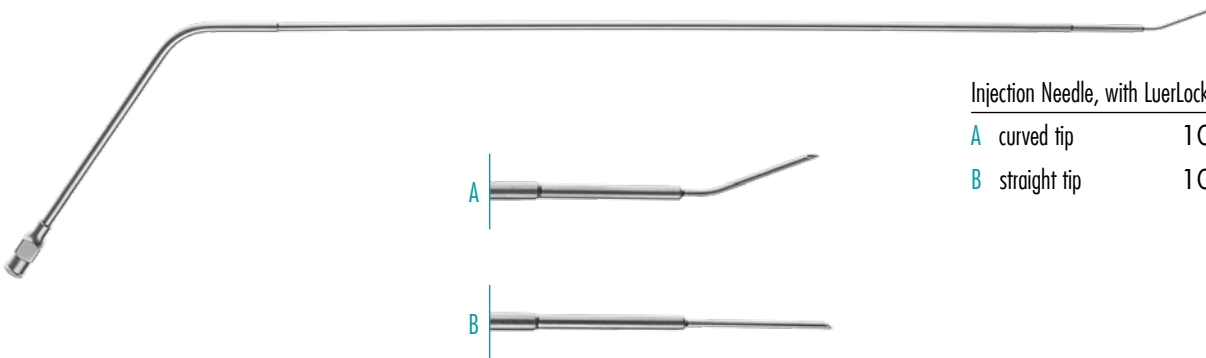

Injection Needle, with LuerLock

A curved tip	100-861-001
B straight tip	100-861-002

Suction/Coagulation Cannula, insulated,
monopolar connection, angled

2.5mm, 280mm, 11"	100-862-030
5.0mm, 270mm, 10 ² / ₃ "	100-864-030

Laser Laryngeal Suction Tubes

with laser protector and smoke channel,
230mm, 9"



round, upwards angled

- Ø 3mm 100-850-503
- Ø 4mm 100-850-504
- Ø 5mm 100-850-505
- Ø 7mm 100-850-547

oval, straight, distal opening left side

100-850-505

oval, straight, distal opening right side

100-850-512

bayonet shaped, distal opening left side

100-850-531

bayonet shaped, distal opening right side

100-850-532

square shaped, distal opening left side

100-850-521

square shaped, distal opening right side

100-850-522

Suction Tube

Ø 2.5mm 100-860-525

Suction Tube, lateral perforated

Ø 3.5mm 100-860-630

Suction Tube, distal closed, lateral perforated

Ø 3.0mm 100-860-730



Teeth Protector, silicone

100-870-100

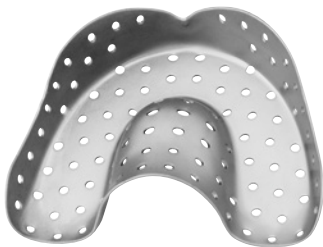

Teeth Protector, metal

Fig. 0 / Children 100-870-000

Fig. 1 100-870-001

Fig. 2 100-870-002

Fig. 3 100-870-003



Bronchoscopy forceps, tubular shaft,
double-action jaws



Foreign Body Forceps, alligator jaws
Ø 2.0mm shaft

250mm, 9 ⁷ / ₈ "	100-720-001
350mm, 13 ³ / ₄ "	100-720-011



Universal Biopsy and Grasping Forceps
Ø 2.0mm shaft

250mm, 9 ⁷ / ₈ "	100-720-002
350mm, 13 ³ / ₄ "	100-720-012



Biopsy Cup Forceps, straight, round cup
Ø 2.0mm shaft

250mm, 9 ⁷ / ₈ "	100-720-003
350mm, 13 ³ / ₄ "	100-720-013



Grasping Forceps, fenestrated jaw
Ø 2.0mm shaft

250mm, 9 ⁷ / ₈ "	100-720-004
350mm, 13 ³ / ₄ "	100-720-014



Foreign Body, alligator jaws
Ø 2.5mm shaft

350mm, 13 ³ / ₄ "	100-720-021
500mm, 19 ³ / ₄ "	100-720-031



Universal Biopsy and Grasping Forceps
Ø 2.5mm shaft

350mm, 13 ³ / ₄ "	100-720-022
500mm, 19 ³ / ₄ "	100-720-032



Grasping Forceps, fenestrated jaw
Ø 2.5mm shaft

350mm, 13 ³ / ₄ "	100-720-024
500mm, 19 ³ / ₄ "	100-720-034

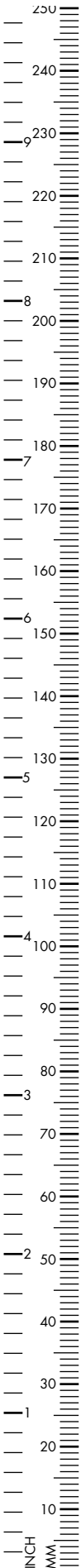

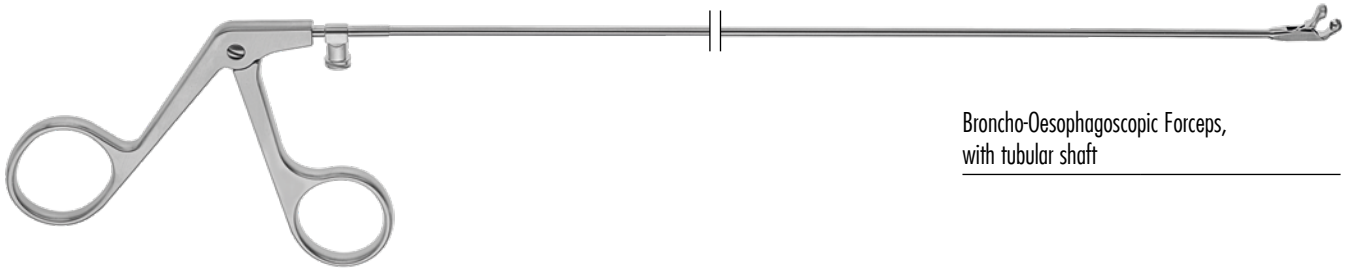

Broncho-Oesophagoscopic Forceps,
with tubular shaft



Grasping Forceps, serrated
Ø 2.5mm shaft

400mm, 15 ^{3/4} "	100-720-402
500mm, 19 ^{1/2} "	100-720-502
600mm, 23 ^{1/2} "	100-720-602
Ø 1.5mm shaft	
350mm, 13 ^{3/4} "	100-720-302



Grasping Forceps, serrated, fenestrated
Ø 2.5mm shaft

400mm, 15 ^{3/4} "	100-720-403
500mm, 19 ^{1/2} "	100-720-503
600mm, 23 ^{1/2} "	100-720-603
Ø 1.5mm shaft	
350mm, 13 ^{3/4} "	100-720-303



Alligator teeth
Ø 2.5mm shaft

400mm, 15 ^{3/4} "	100-720-404
500mm, 19 ^{1/2} "	100-720-504
600mm, 23 ^{1/2} "	100-720-604
Ø 1.5mm shaft	
350mm, 13 ^{3/4} "	100-720-304



Cupped Forceps, straight
Ø 2.5mm shaft

400mm, 15 ^{3/4} "	100-720-405
500mm, 19 ^{1/2} "	100-720-505
600mm, 23 ^{1/2} "	100-720-605
Ø 1.5mm shaft	
350mm, 13 ^{3/4} "	100-720-305



Cupped Forceps, horizontal upcurved
Ø 2.5mm shaft

400mm, 15 ^{3/4} "	100-720-406
500mm, 19 ^{1/2} "	100-720-506
600mm, 23 ^{1/2} "	100-720-606
Ø 1.5mm shaft	
350mm, 13 ^{3/4} "	100-720-306



Cupped Forceps, vertical upcurved
Ø 2.5mm shaft

400mm, 15 ^{3/4} "	100-720-407
500mm, 19 ^{1/2} "	100-720-507
600mm, 23 ^{1/2} "	100-720-607
Ø 1.5mm shaft	
350mm, 13 ^{3/4} "	100-720-307



Cupped Forceps, right curved
Ø 2.5mm shaft

400mm, 15 ^{3/4} "	100-720-408
500mm, 19 ^{1/2} "	100-720-508
600mm, 23 ^{1/2} "	100-720-608
Ø 1.5mm shaft	
350mm, 13 ^{3/4} "	100-720-308



Cupped Forceps, left curved
Ø 2.5mm shaft

400mm, 15 ^{3/4} "	100-720-409
500mm, 19 ^{1/2} "	100-720-509
600mm, 23 ^{1/2} "	100-720-609
Ø 1.5mm shaft	
350mm, 13 ^{3/4} "	100-720-309

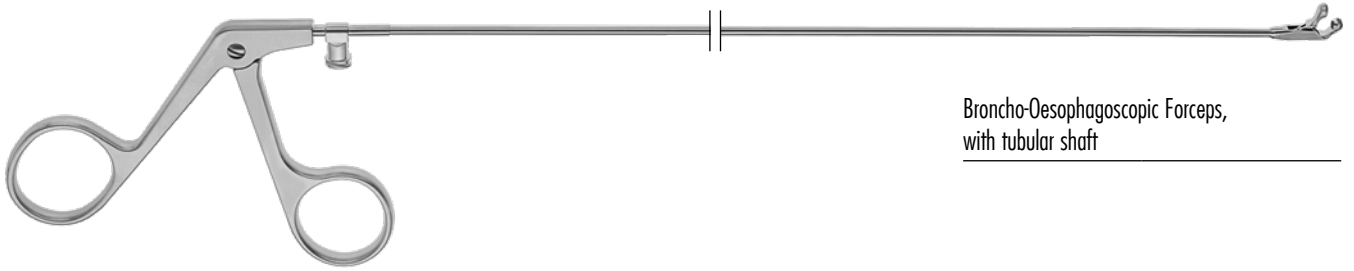

Broncho-Oesophagoscopic Forceps,
with tubular shaft



Cupped Forceps, oblong, straight
Ø 2.5mm shaft

400mm, 15 ³ / ₄ "	100-720-410
500mm, 19 ¹ / ₂ "	100-720-510
600mm, 23 ¹ / ₂ "	100-720-610



Cupped Forces, oval, straight
Ø 2.5mm shaft

400mm, 15 ³ / ₄ "	100-720-411
500mm, 19 ¹ / ₂ "	100-720-511
600mm, 23 ¹ / ₂ "	100-720-611



Cupped Forces, oval, straight
Ø 2.5mm shaft

400mm, 15 ³ / ₄ "	100-720-412
500mm, 19 ¹ / ₂ "	100-720-512
600mm, 23 ¹ / ₂ "	100-720-612
Ø 1.5mm shaft	
350mm, 13 ³ / ₄ "	100-720-312



Cupped Forceps, oval, serrated, straight
Ø 2.5mm shaft

400mm, 15 ³ / ₄ "	100-720-413
500mm, 19 ¹ / ₂ "	100-720-513
600mm, 23 ¹ / ₂ "	100-720-613
Ø 1.5mm shaft	
350mm, 13 ³ / ₄ "	100-720-313

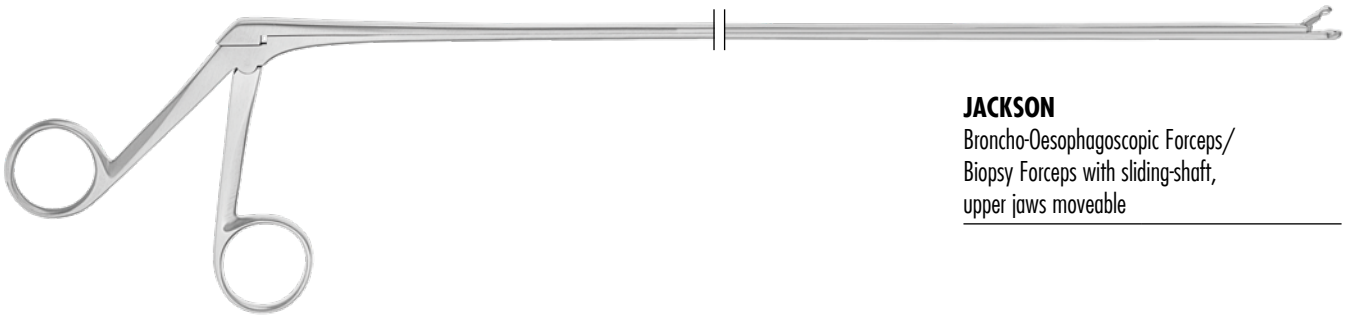
**JACKSON**

Broncho-Oesophagoscopic Forceps/
Biopsy Forceps with sliding-shaft,
upper jaws moveable



serrated

300mm, 11 ⁷ / ₈ "	100-750-301
400mm, 15 ³ / ₄ "	100-750-401
500mm, 19 ¹ / ₂ "	100-750-501
600mm, 23 ¹ / ₂ "	100-750-601



1x2 teeth

300mm, 11 ⁷ / ₈ "	100-750-302
400mm, 15 ³ / ₄ "	100-750-402
500mm, 19 ¹ / ₂ "	100-750-502
600mm, 23 ¹ / ₂ "	100-750-602



Alligator teeth

300mm, 11 ⁷ / ₈ "	100-750-303
400mm, 15 ³ / ₄ "	100-750-403
500mm, 19 ¹ / ₂ "	100-750-503
600mm, 23 ¹ / ₂ "	100-750-603

cupped jaws, straight
Ø 2.0mm

300mm, 11 ⁷ / ₈ "	100-750-304
400mm, 15 ³ / ₄ "	100-750-404
500mm, 19 ¹ / ₂ "	100-750-504
600mm, 23 ¹ / ₂ "	100-750-604

cupped jaws, upcurved
Ø 2.0mm

300mm, 11 ⁷ / ₈ "	100-750-306
400mm, 15 ³ / ₄ "	100-750-406
500mm, 19 ¹ / ₂ "	100-750-506
600mm, 23 ¹ / ₂ "	100-750-606



spoon, oblong, straight

300mm, 11 ⁷ / ₈ "	100-750-308
400mm, 15 ³ / ₄ "	100-750-408
500mm, 19 ¹ / ₂ "	100-750-508
600mm, 23 ¹ / ₂ "	100-750-608

cupped jaws, straight
Ø 4.0mm

300mm, 11 ⁷ / ₈ "	100-750-305
400mm, 15 ³ / ₄ "	100-750-405
500mm, 19 ¹ / ₂ "	100-750-505
600mm, 23 ¹ / ₂ "	100-750-605

cupped jaws, straight
Ø 4.0mm

300mm, 11 ⁷ / ₈ "	100-750-307
400mm, 15 ³ / ₄ "	100-750-407
500mm, 19 ¹ / ₂ "	100-750-507
600mm, 23 ¹ / ₂ "	100-750-607



punch, angular

300mm, 11 ⁷ / ₈ "	100-750-309
400mm, 15 ³ / ₄ "	100-750-409
500mm, 19 ¹ / ₂ "	100-750-509
600mm, 23 ¹ / ₂ "	100-750-609

punch, round

300mm, 11 ⁷ / ₈ "	100-750-310
400mm, 15 ³ / ₄ "	100-750-410
500mm, 19 ¹ / ₂ "	100-750-510
600mm, 23 ¹ / ₂ "	100-750-610

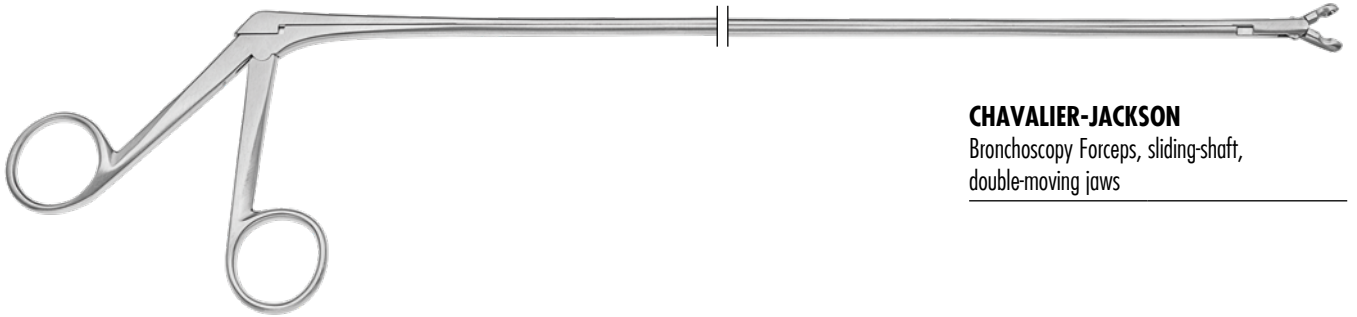

CHAVALIER-JACKSON
Bronchoscopy Forceps, sliding-shaft,
double-moving jaws



Grasping Forceps, serrated jaw

300mm, 11 ^{7/8} "	100-755-305
400mm, 15 ^{3/4} "	100-755-405
500mm, 19 ^{1/2} "	100-755-505
600mm, 23 ^{1/2} "	100-755-605



Grasping Forceps, serrated jaw

300mm, 11 ^{7/8} "	100-755-304
400mm, 15 ^{3/4} "	100-755-404
500mm, 19 ^{1/2} "	100-755-504
600mm, 23 ^{1/2} "	100-755-604



Cupped Forceps

300mm, 11 ^{7/8} "	100-755-310
400mm, 15 ^{3/4} "	100-755-410
500mm, 19 ^{1/2} "	100-755-510
600mm, 23 ^{1/2} "	100-755-610

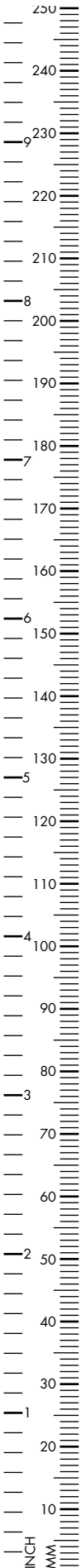

INDEX

